



buffet | tabletop | bar

# GASTRONOMIE- UND SERVIERARTIKEL

FOOD SERVICE EQUIPMENT  
EQUIPAMIENTOS PROFESIONALES  
EQUIPEMENT PROFESSIONNEL



Ihr Vollanbieter:

**GASTRO**  **IMPULS**  
Hunkeler Gastro AG

Hunkeler Gastro AG  
Grimselweg 5 · 6002 Luzern  
Tel. +41 41 368 91 91 · Fax +41 41 368 91 90  
[www.gastroimpuls.ch](http://www.gastroimpuls.ch) · [info@gastroimpuls.ch](mailto:info@gastroimpuls.ch)

# 2023

SINCE 1933

# 90

years

run by family

# APS – Werkstatt und Bühne für den Genuss

APS – Workshop and stage for enjoyment



family-run company  
since 1933

managing director Reinhold Pott | Bastian Becker



- Eigene Produktion in Deutschland
- 25.000 Euro-Palettenlagerplätze
- own production in Germany
- 25,000 Euro pallet storage spaces



buffet | tabletop | bar

**Assheuer + Pott GmbH & Co. KG**  
Talweg 11 | 59846 Sundern  
Germany

Phone: +49 (0) 2933 / 97 35 - 0  
E-Mail: [info@aps-germany.de](mailto:info@aps-germany.de)  
[aps-germany.de](http://aps-germany.de)



Keep in touch! [aps\\_germany](https://www.aps-germany.de)



Visit our website!



# Ihr Mehrwert: Inspiration & Service

- ✓ aktuellste Nonfood-Trends im Sortiment
- ✓ hohe Warenverfügbarkeit

# Your added value: Inspiration & Service

- ✓ latest nonfood-trends in the range
- ✓ high availability of goods



p. 36



p. 59



p. 99



p. 144



p. 177



p. 207



p. 234



p. 252



p. 276



p. 308



p. 320



p. 324



p. 334



p. 352



p. 364



p. 372



p. 385



p. 414



p. 438



p. 456



p. 475



p. 484



p. 487



p. 491



Buffet & Display

Buffet & Tableware  
Melamin

Tableware &  
Table Presentation

Baskets

Chafing Dish,  
GN Container & Transport

Bar, Café & Drinkware

Kitchen & Servingtools

Covers & Accessories

# APS – KNOW-HOW

We only work with the raw material manufacturer who has the best technology in the industry.



## MELAMINE

- ✓ 100% pure melamine
- ✓ BPA free, urea free
- ✓ perfect for serving dishes
- ✓ extremely break and shock resistant
- ✓ sustainable due to durability and robustness
- ✓ hygienic surfaces
- ✓ environmentally friendly due to low processing temperature
- ✓ 100% dishwasher safe
- ✓ useable up to max. 70°C

## STAINLESS STEEL

Chrome-nickel steel is used in a wide variety of products due to its attractive appearance, as a brightly polished, ground or brushed variant.

- ✓ hygienic surface
- ✓ durable and easy to clean
- ✓ recyclable
- ✓ good temperature conductor
- ✓ 100% dishwasher safe

## PLASTIC PP - PS - SAN - TRITAN

- ✓ crystal clear
- ✓ BPA free
- ✓ hygienic surface
- ✓ high resistance to heat
- ✓ easy to clean
- ✓ durable, no disposable plastic
- ✓ recyclable



## WOOD

acacia-beech-oak-olive



## PORCELAIN



# Präzisionsarbeit und Design für Ihren Erfolg

Precision work and design for your success

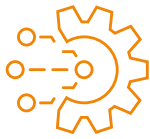

state-of-the-art  
manufacturing  
technology



eco-friendly



high  
professional  
usability

## QUALITÄT

- ✓ Jedes Produkt muss mehr als zwei Qualitätskontrollen bestehen.
- ✓ Wir verwenden nur 100% reines Material.
- ✓ Jedes Rohmaterial wird streng geprüft.

## QUALITY

- ✓ Each product must pass more than two quality checks.
- ✓ We only use 100% pure material.
- ✓ Each raw material is strictly tested.

## DESIGN

- ✓ Unsere eigenständig entwickelten Produkte verfügen über zahlreiche Design-Patente im In- und Ausland.
- ✓ Wir entwickeln Produktlösungen für jeden individuellen Kundenbedarf.

## DESIGN

- ✓ Our independently developed products have rich / multi design patents at home and abroad.
- ✓ We develop product solutions for every individual customer need.



APS production | Made in Germany



Design team

# DEUTSCH

## Artikel Seite

### A

Abräumwagen	360, 364-365
Abtropfmatte	409
Adapter / Zwischensteg	354, 356
Allzweckgießer	368-369, 416
Antirutschmatte	36, 383
Aschenbecher	427-430
Aufstrichmesser	461
Auslagenplatte	135, 289, 311
Ausgießer	50-51, 260-263, 265-266, 369, 400, 411-412, 470
Ausstellblech	251, 469
Austernmesser	458

### B

Backblech	111, 251, 360
Backform	469, 478-479
Backhandschuhe	478
Baquette Korb	92, 310, 316
Bain-Marie	335-336, 338-340, 343-346, 348, 466
Bar-Caddy	409
Barlöffel	399
Barmaß	397, 398
Barmatte	409
Barsieb	400, 464
Becher	39-40, 123, 218, 240, 270, 280, 305, 385, 387-396, 427-432, 434, 467-468, 497
Becher Emaille	280
Behälter	294-296, 312, 368, 401
Bento Box	156-157
Beschriftungsetiketten	304
Beschriftungskarten	298-301
Besteckablage	218, 351
Besteckbehälter	21, 137-138, 295, 312, 366-367
Besteckkorb	294, 317
Besteckständer	294
Bestecktaschen	277
Beton	141, 168, 260, 272, 274-275, 298, 381, 384

Bierglasträger	131, 423
Blattschale Melamin	176, 217, 490
Bonleiste	473
Bonspieß	473
Brennpastenbehälter Edelstahl	350
Brezel- oder Wurstständer	84
Brotstation	88
Brotkorb	88, 93, 318-319, 326-327
Brot Schneidebrett	59, 88, 130
Brötchenschütze	215
Brötchenspender Edelstahl	93
Brottasche	320-322
Buffet Box	70
Buffet Kühlset	18, 112
Buffet-Set	93
Buffetbrett	52, 117-118, 129
Buffetgestell	93
Buffetkorb	16, 93, 314-315, 319
Buffetleiter	77, 78, 80-81, 93
Buffetschilder	20, 45, 304, 495
Buffetständer	61, 66, 69, 74-75, 91, 96-98, 118, 157, 184, 217, 287
Buffetständer Edelstahl	98
Buffetständer Holz	61, 66, 74-75, 98
Buffetständer Metall	69, 96-97, 118, 157, 184, 287
Buffetvitrine	25-28, 34
Buffetvitrine Edelstahl	25-26, 28, 34
Butterdose	270
Butterservierer	270
Bürste Bar	412

### C

Caddy	126, 141, 246, 272-273, 296, 409
-------	----------------------------------

Cerealienspender	21, 59-62
Cerealienspender Edelstahl	21, 59-62
Chafing Dish	334-346
Chafing Dish Rolltop	348
Champagnerkühler	376-378
Cocktailmesser	401

### D

Darioform	469
Deckel	65, 77, 209-210, 214, 225, 286, 355-358, 480, 493-495
Deckel Edelstahl	355-356
Dekoriermesser	401, 458
Dip-Schälchen	196, 202, 213, 221, 223, 229, 237-239
Dispenser Saft	20, 41, 43-45
Dispenser Milch	20, 44-46
Dosier- & Vorratsflasche	411, 475-476
Dosierer Zucker	267-268, 417-418
Dosierpumpe	477
Dosierspender	477
Dressingtopf Edelstahl	73
Dressingtopf Melamin	73
Dressingtopf Porzellan	73

### E

Eier-Box	368, 477
Eierbecher	218, 270
Eierkorb	311
Eierschneider	462
Eimer	369
Eis-Kugel-Former	404
Eisbox	405
Eiseimer	373, 405-406
Eisportionierer	474
Eisschaufel	406
Eiswaffel-Ständer	474
Eiswasserröhre	36, 52-53, 383
Eiswürfelform	404
Eiszange	407
Eiszerkleinerer	406
Emaille-Artikel	211, 270, 279-280, 287
Entkerner	457
Etagère	67-68, 82-87, 116, 186, 216

### F

Fadenschneider	456
Fast-Food Tablett	133
Feuerzangenbowle-Set	271, 347
Fingerfood-Löffel	200, 219-220
Flambierbrenner	474
Flasche	52-53, 266, 281, 411, 413, 433, 475-476
Flaschenhalter Wein	382
Flaschenkühler	54, 56, 228, 372, 375-376, 379-382, 388, 410
Flaschenöffner	56, 413
Folien-Abreißvorrichtung	473
Fondue-Set	271, 347
Frischhaltedeckel	19, 286

### G

Gabel Fleisch	439, 442-443
Gabel Salat	438, 441, 454
Spitzsieb	464
Gebäckpalette	459
Gebäckzange	446-447, 450-451
Gemüsehobel	466
Getränkspender	36-40, 383-384
Getränkewanne	55, 377
Gewürzständer	265
Gewürzstreuer	258
Gläsernschiene	392
Glasumrandler	409
Glocke	292, 426
Gourmetlöffel	240, 453
GN Abtropfgitter	356, 358
GN Behälter	100, 224-225, 353-354, 357-359, 361-363
GN Behälter Edelstahl	100, 353-354

GN Besteckbehälter	137-138, 312, 360, 367
GN Buffetgestell	316
GN Buffetleiter	80-81
GN Buffetständer	157
GN Buffetvitrine Edelstahl	25-26, 28
GN Chafing Dish	335-336, 338-339, 343-346

GN Deckel	225, 355-358, 362
GN Haube	17, 99-100, 316, 318, 348, 484-487
GN Korb	16, 309, 312-314, 324
GN Korb Metall	324
GN Korb Polypropylen	16, 309, 312-314
GN Naturschieferplatte	24, 250
GN Partyplatte	108
GN Rost	360
GN Schale Melamin	153-154, 182, 224-225
GN Servierbrett	424
GN Serviergestell	17
GN Tablett	153, 156, 159, 161, 166, 169-170, 173, 183, 185, 188, 193, 202, 204, 206-207
GN Tablett Edelstahl	15, 29, 99-101, 204
GN Tablett Melamin	24, 66, 153, 156, 159, 161, 166, 169-170, 173, 183, 185, 188, 193, 202, 204, 206-207
GN Tablett Porzellan	15, 360
GN Wanne	15, 24
Gourmetgläser	285

### H

Häkelkorb	322
Haube	14, 16-17, 94, 99-102, 104-107, 122, 136, 166, 170, 180, 217, 290, 316, 318, 348, 484-497
Haube Rolltop	16-17, 25-30, 102, 112, 129, 217, 315, 348, 487
Haube Rolltop Edelstahl	348
Haubenhalterung	94
Heizelement	47, 348-350
Hobel	84, 458, 466
Holzbox	128, 246, 272-273
Honiglöffel	455
Hummerbrecher	462
Hygieneschutz	84, 90, 93

### I

Induktionskochplatte	76, 334, 336-338, 340-341, 349
Iso-Dispenser	41
Isolierkanne	47-49

### K

Kaffeebecher	280, 305, 432
Kaffeedispenser Edelstahl	47, 348
Kaffeekanne	415
Kanne	45-50, 52-53, 57, 235, 269, 414-416, 419
Kanne Saft	50, 52-53
Karaffe Glas	50-53
Kartenhalter	297-302
Käsehobel	458
Kaviarkühler	106, 271
Kellnermesser	413
Kerzenleuchter	274
Kreide-Marker	304
Konditorplatte	216
Konferenzkühler	410
Korb Edelstahl	234, 326-327
Korb Metall	234, 323-325, 327-328
Korb Polypropylen	294, 308-319
Korkenzieher	413
Kronkorkenschale	56
Kugelausstecher	456
Kühlakku	27-34, 42, 496
Kühlbox	18, 28-30, 54, 112
Kühlkaraffe	50
Kühlmanschette	382
Kühlschale	19, 31-33

Kühltablett	14, 27, 29
-------------	------------

L	
Likör- und Fondanttrichter	466
Limettenpresse	403, 472
Löffel	218-220, 240, 399, 438-445, 453, 455, 465
Löffel Backen	465
Löffel Feinkost	453
Löffel Fingerfood	2000, 219-220
Löffel Frittieren	465
Löffel Gourmet	240, 253
Löffel Salat	218, 438, 441, 454
Löffel Saucen, Dressing	441, 453, 481
Löffel Spaghetti	440
Lunchbag	322, 434
Lunchbox	329, 435

### M

Magnet-Messerhalter	473
Mandoline	466
Mehrwegbecher	305, 432, 497
Menage	256, 259-266
Messbecher	467-468
Messlöffelsatz	451
Metallrahmen für Induktionskochplatte	336-338, 349
Milchdispenser	20, 44
Milchgießer/-kännchen	235, 269
Milchkanne	45-46, 235, 269, 414-416
Minis	212, 220-221, 232-233, 235, 257, 269, 394, 416,
Moscow Mule Becher	388-390
Mühle Pfeffer	252-257, 266
Mühle Salz	252-257, 266
Multi Rack Edelstahl	95
Multibox	58
Muscheltopf	287
Müslispender	21, 59-61

### N

Naturschieferplatte	24, 87, 112-116, 120-121, 249-250, 256
---------------------	--

### P

Palmbattschale Melamin	176, 190, 214
Panierstation	472
Parmesan Menage	264-265
Partyplatte	108
Passiersieb	463-464
Pendelschäler	457
Permanent-Ausgießer	412
Pfanne	102, 231-233
Pfannenwender	439, 444
Pfeffermühle	252-257, 266
Pinself	272, 281
Pinzettzange	407, 452
Pitcher	54, 380
Pizzaform	478-480
Pizzaschaufel	479
Pizzaschneider	457, 462, 480
Platzsets	276-278
Platzteller	292
Pommes-Frites-Seiher	465
Porzellan	46, 338, 340
Pump-Isolierkanne	47

### Q

Quetschflasche	475-476
----------------	---------

### R

Rechnungstablett	293, 426
Regalwagen	365
Reinigungsbürste	412
Rezeptionsglocke	426
Rolltop-Set	30, 106, 115
Rührbecher	468
Rührglas	411

### S

Saftdispenser	20, 41, 43-45
Saftkanne	50, 52-53
Salatbesteck	438, 454

Salatzange	445-449	Stößel	402
Salat-Löffel	441	Stövchen	58
Salzmühle	252-257, 266	Streichpalette	459
Sauciere	291-292	Streuer	257-258, 465
Schälchenspender	79	Streuer Pfeffer	257, 465
Schale Aluminium	237, 323	Streuer Salz	257-258, 465
Schale Beton	74	Superbox	21-24, 330-331
Schale Edelstahl	19, 102, 229, 232, 235-237, 327	Suppenkelle	441, 443, 445
Schale Emaille	279-280, 287	Suppentopf	337, 345-346
Schale Glas	77, 106	Sushiboard Holz	124, 247
Schale Holz	69, 119, 127-128, 241-242, 495	Sushiboard Melamin	147-148, 198
Schale Melamin	145-154, 156, 160, 162-165, 167-169, 172, 174, 176, 179, 181-186, 190-191, 194-199, 201-223, 493	<b>T</b>	
Schaufel Eis	406	Tablet Caddy	126, 128, 141, 246, 272-273
Schaufel Mehl	470, 481	Tablett 14-15, 24, 27, 29, 35, 72, 83, 88, 94, 99-106, 109-111, 124-125, 131-133, 144, 146-148, 153, 156, 159-161, 163, 166, 169-174, 179, 183, 185-189, 192-194, 198, 200, 202, 204, 206-207, 210, 215, 217, 360, 423, 426	
Schaumlöffel	440, 445	Tablett Edelstahl	14-15, 34-35, 99-106, 109-111, 228, 251, 293, 420-422, 426
Schaumspesierung	468	Tablett Fast Food	133, 425
Schiefer	24, 28, 87, 112-116, 120-121, 244, 249-250, 256	Tablett Holz	83, 88, 94, 107, 124-125, 132, 243, 246-247, 424
Schilder	297-299, 304, 495	Tablett Melamin	83, 88, 144, 146-148, 153, 156, 159-161, 163, 166, 169-174, 179, 183, 185-189, 192-194, 198, 200, 202, 204, 206-207, 210, 215, 217, 363
Schlüsselschnur	410	Teebox	58
Schneebesen	462	Teebrühsieb	418
Schneidbrettständer	474	Teekanne ASIA	57, 419
Schneidebrett	15, 88-89, 130, 401	Teigbehälter	368, 480
Schöpflöffel	438, 440, 442-443, 445	Teigschaber / Abstecher	461, 480
Schutzmantel	48	Teller Emaille	279
Sektkühler	55, 372-375, 377-378	Teller Fingerfood	204
Senftöpfchen	261	Teller Melamin	144, 146-148, 160, 162, 164, 175, 192, 194, 198, 204, 208, 217, 222
Servierbox	187	Thermometer	415
Serviertöpfchen	106, 232-233	Thermo Tablett-Set	35
Servier- / Tortenplatte Edelstahl	105, 135, 289	Thermo-Set	30
Servier- / Tortenplatte Holz	122, 134-135, 288-289	Tischrestehälter	295-296
Servier- / Tortenplatte Melamin	134, 216, 288	Tischaufsteller	300, 304
Servierbrett	83, 119-126, 128-129, 242-249	Tischkartenhalter	297-302
Servierfrittierkorb	114, 234	Tischkrümelentferner	292, 426
Serviergabel	438-439, 442-443, 453	Tischsets	276-278
Serviergestell	79, 84-86, 286	Tortenheber	439, 441
Servierkelle	230, 441	Tortenmesser	439
Servierkorb	234, 237	Tortenplatte	105, 115, 122, 134-135, 216, 288-289
Servierlöffel	218, 438, 440-443, 445	Tortenring	469
Servierpfanne	102, 232-233	To-Go Becher	305, 432, 497
Servierpfanne Gusseisen	231	Transportwagen	364-365
Servierset	150-151	Tretbeutelhalter	431
Serviertablett	109-111, 125, 131-132, 246, 251, 421-424	Trichter	369, 466, 471
Servierwagen	364-365	Trinkbecher	39-40, 385, 387
Servierzange	446	Trinkflasche	433
Serviettenhalter	139-141	Trinkglas	38, 386
Serviettenringe	293	Trinkhalme	408
Serviettentaschen	277	Tropfenschale Melamin	37, 39, 384
Shaker	395-396	<b>U</b>	
Sieb	400-401, 418, 463-464	Universalbox	65
Snackbox	126-127, 230, 243	Universalkanne	414-415
Snackholder	232-239	Untersetzer Edelstahl	293
Snackpresenter	92	Untersetzer Kork	40
Snackspender	240, 393	Untersetzer Naturschiefer	114, 250, 256
Spachtel	461	<b>V</b>	
Spaghettizange	445, 449	Vase	275
Spargelzange	486	Verschluss Wein / Champagner	412
Sparschäler	456	Vorspeisenzange	449
Speisenwärmer	350	Vorratsglas	63-64
Spießständer / Spieße	271	<b>W</b>	
Spritzflasche	266, 411	Wachspapier	111, 114, 126, 236, 251, 420
Standascher	430	Wanne	15, 368
Ständer	61, 66, 69, 74-75, 84, 96-98, 157, 179-180, 184, 216-217, 271, 287, 328, 474	Warenträger	108, 276
Ständer Wein- / Sektkühler	374	Wärme-Kies	351
Staubkappen	410		
Stielkasserolle	233		
Stift	304		

Warnschild	477, 496
Wasserbadschüssel	466
Wasserkanne	50, 52-53
Wasserspender	36-40, 383-384
Weck Gläser	65, 282-286
Weinkühler	55, 372-375, 377-378, 382
Weinkühlerständer	374
Wender	439-440, 443-444, 459-460
Windaschenbecher	427-429
Windlicht	274

<b>Z</b>	
Zange	407, 445-452
Ziseliermesser	456
Zitronenschnitzelpresse	418
Zitruspresse	403, 472
Zuckerdosierer	267-268, 417-418
Zuckerkuigel	267, 417
Zuckerspender	267-268, 417-418
Zutatenbehälter	401

## ENGLISH

item	page
<b>A</b>	
adapter	354, 356
air pot	47
airtight cover	19, 286
ashtray	427-430
asparagus tongs	486
<b>B</b>	
baguette basket	92, 310, 316
Bain-Marie	335-336, 338-340, 343-346, 348, 466
baking mittens	478
baking pan	469, 478-479
baking sheet	111, 251, 360
bar caddy	409
bar knife	401
bar spoon	399
bar strainer	400, 464
barrel mug	39-40, 123, 218, 240, 270, 280, 305, 385, 387-396, 427-432, 434, 467-468, 497
basket metal	234, 323-325, 327-328
basket polypropylene	294, 308-319
basket stainless steel	234, 326-327
beaker	280
beer rack	131, 423
Bento Box	156-157
beverage dispenser	36-40, 383-384
beverage tub	55, 377
bill presenter	293, 426
bill rail	473
bill spike	473
bottle	52-53, 266, 281, 411, 413, 433, 475-476
bottle cooler	54, 56, 228, 372, 375-376, 379-382, 388, 410
bottle fuel	350
bottle opener	56, 413
bowl aluminium	237, 323
bowl concrete	74
bowl enamel	279-280, 287
bowl glass	77, 106
bowl holder	79
bowl melamine	145-154, 156, 160, 162-165, 167-169, 172, 174, 176, 179, 181-186, 190-191, 194-199, 201-223, 493
bowl stainless steel	19, 102, 229, 232, 235-237, 327
bowl wood	69, 119, 127-128, 241-242, 495
bread basket	320-322
bread station	88
Breadbox	88, 93, 318-319, 326-327
breeding set	472
brush	272, 281

bucket	369
buffet basket	16, 93, 314-315, 319
buffet box	70
buffet ladder	77, 78, 80-81, 93
buffet set	93
buffet signs	20, 45, 304, 495
buffet stand	61, 66, 69, 74-75, 91, 93, 96-98, 118, 157, 184, 217, 287
buffet stand metal	69, 96-97, 118, 157, 184, 287
buffet stand stainless steel	98
buffet stand wood	61, 66, 74-75, 98
Buffett-board	52, 117-118, 129
butter dish	270
butter dish	270
<b>C</b>	
caddy	126, 141, 246, 272-273, 296, 409
cake lifter	439, 441
cake plate melamine	134, 216, 288
cake plate stainless steel	105, 135, 289
cake plate wood	122, 134-135, 288-289
cake setting ring	469
cake slice	439
cake stand	105, 115, 122, 134-135, 216, 288-289
candle holder	274
cap bowl	56
cast iron pan	231
caviar cooler	106, 271
cereal dispenser	21, 59-62
cereal dispenser stainless steel	21, 59-62
Chafing Dish	334-346
Chafing Dish Rolltop	348
chalk marker	304
champagne bowl	55, 372-375, 376-378
cheese dish	264-265
cheese slicer	458
chefs blow torch	474
chopping board	15, 88-89, 130, 401
cleaning brush	412
clingfilm tear-off dispenser	473
cloche / dome cover	292, 426
coaster cork	40
coaster natural slate	114, 250, 256
coaster stainless steel	293
coffee cup	280, 305, 432
coffee dispenser stainless steel	47, 348
coffee pot	415
concrete	141, 168, 260, 272, 274-275, 298, 381, 384
confectionery funnel	466
conference bottle cooler	410
conical strainer	464
container	294-296, 312, 368, 401
cool collar	382
cooler	27-34, 42, 496
cooling bowl	19, 31-33
cooling box	18, 28-30, 54, 112
cooling carafe	50
cooling plates	14, 27, 29
corer	457
corkscrew	413
cornet stand	474
cover	14, 16-17, 65, 77, 94, 99-102, 104-107, 122, 136, 166, 170, 180, 209-210, 214, 217, 225, 286, 290, 316, 318, 348, 355-358, 480, 484-497
cover holder	94
cover stainless steel	355-356
crochet rope basket	322
crumber	292, 426
curler	84, 458, 466
cutlery bag	277
cutlery basket	294
cutlery dispenser	294, 317

cutlery organizer	21, 137-138, 295, 312, 366-367	GN-container	100, 224-225, 353-354, 357-359, 361-363	peeler	456	spice rack	265
cutlery rest	218, 351	GN-drainer	356, 358	pen	304	spice shaker	258
cutting board	59, 88, 130	GN-lid	225, 355-358, 362	pepper mill	252-257, 266, 465	spider spoon	465
cutting board rack	474	gourmet glasses	285	pitcher	45-50, 52-54, 57, 235, 269, 380, 414-416, 419	spoon	218-220, 240, 399, 438-445, 453, 455, 465
<b>C</b>		graduated jug	467-468	pizza cutter	457, 462, 480	squeeze bottle	266, 411, 475-476
Dariol moulds	469	gravy boat	291-292	pizza dish	478-480	stainless steel frame for induction plate	336-338, 349
decorating knife	401, 458	<b>H</b>		pizza peel	479	stand for wine / champagne bowl	374
decorator / zester	456	heating unit	47, 348-350	placemat	276-278	standing ashtray	430
delicatessen spoon	453	honey spoon	455	plate enamel	279	stirring cup	468
designation cards	298-301	hygienic cover	84, 90, 93	plate melamine	144, 146-148, 160, 162, 164, 175, 192, 194, 198, 204, 208, 217, 222	strainer	400-401, 418, 463-464
dip bowl	196, 202, 213, 221, 223, 229, 237-239	<b>I</b>		plate tray	292	straws	408
dispenser	477	ice ball former	404	plate warmer	350	superbox	21-24, 330-331
dispenser sugar	267-268, 417-418	ice box	405	porcelain	46, 338, 340	sushiboard melamine	147-148, 198
display plate	135, 289, 311	ice bucket	373, 405-406	pourer	368-369, 416	sushiboard wood	124, 247
display tray	251, 469	ice cream scoop	474	pourers 50-51, 260-263, 265-266, 369, 400, 411-412, 470		swivel peeler	457
dosing pump	477	ice crusher	406	pouring container	411, 475-476	<b>T</b>	
dough container	368, 480	ice cube cooling tube	36, 52-53, 383	pretzel-/ sausage stand	84	table caddy	126, 128, 141, 246, 272-273
dough scraper	461, 480	ice cube maker	404	protective coat	48	table garbage bin	295-296
dressing pot melamine	73	ice scoop	406	<b>R</b>		table stands	297-302, 304
dressing pot porcelain	73	ice tong	407	refrigerated buffet display	18, 112	tea-box	58
dressing pot stainless steel	73	induction plate	76, 334, 336-338, 340-341, 349	reusable cup	305, 432, 497	teapot ASIA	57, 419
dressing/sauce spoon	441, 453, 481	insulated dispenser	41	ring bell	426	teapot warmer	58
drinking bottle	433	<b>J</b>		roll / bun basket	215	thermo set	30
drinking cups	38-40, 385-387	jigger	397, 398	roll dispenser stainless	93	thermo tray	35
drip mat	39, 389	jug	414-415	rolltop cover	16-17, 25-30, 102, 112, 129, 217, 315, 348, 487	thermometer	415
drip tray melamine	37, 39, 404	juice dispenser	20, 41, 43-45	rolltop set	30, 106, 115	To-Go cup	305, 432, 497
dust & fly cap	410	juice pitcher	50, 52-53	rolltop-cover stainless steel	348	tray	14-15, 24, 27, 29, 35, 67-68, 72, 82-88, 94, 99-106, 109-111, 116, 124-125, 131-133, 144, 146-148, 153, 156, 159-161, 163, 166, 169-174, 179, 183, 185-189, 192-194, 198, 200, 202, 204, 206-207, 210, 215-217, 246, 251, 360, 421-424, 426
<b>E</b>		<b>K</b>		<b>S</b>		tray melamine	83, 88, 144, 146-148, 153, 156, 159-161, 163, 166, 169-174, 179, 183, 185-189, 192-194, 198, 200, 202, 204, 206-207, 210, 215-217, 246, 251, 360, 421-424, 426
egg basket	311	key cord	410	salad fork	438, 441, 454	tray stainless steel	14-15, 34-35, 99-106, 109-111, 228, 251, 293, 420-422, 426
egg cutter	462	<b>L</b>		salad spoon	218, 438, 441, 454	tray wood	83, 88, 94, 107, 124-125, 132, 243, 246-247, 424
egg holder	218, 270	labeling labels	304	salad spoon + fork	438, 454	trolley	365
eggs box	368, 477	labels	297-299, 304, 495	salad tong	445-449	turner	439, 444
enamel articles	211, 270, 279-280, 287	ladle	438, 440, 442-443, 445	salt mill	252-258, 266, 465	tweezer	407, 452
<b>F</b>		leaf melamine	176, 217, 490	sandwich knife	461	<b>U</b>	
fingerfood plate	204	lime press	403, 472	sauté pan / mini sauce pan	233	universal box	65
fire punch bowl set	271, 347	lobster cracker	462	scoop	248, 454-455	<b>V</b>	
flower vase	275	lunch bag	322, 434	scoop flour	470, 481	vacuum jug	47-49
fondue set	271, 347	lunchbox	329, 435	scraper	461	<b>W</b>	
fork	438-439, 442-443, 453	<b>M</b>		service trolley	364-365	waiter's corkscrew	413
free flow pourer	412	magnetic knife rack	473	serving basket	234, 237	whisk	462
fry baskets	114, 234	mandolin	466	serving board	83, 119-126, 128-129, 242-249	winebottle-stand	382
fry dripping tray	465	mandolin	466	serving box	187	woodbox	128, 246, 272-273
funnel	369, 466, 471	meatfork	439, 442-443	serving cup	232-239		
<b>G</b>		melon baller	456	serving set	150-151		
glass carafe	50-53	menage	256, 259-266	serving spoon	218, 438, 440-443, 445		
glass rack	392	milk dispenser	20, 44-46, 235, 269, 414-416	serving stand	61, 66, 69, 74-75, 79, 84-86, 96-98, 157, 179-180, 184, 216-217, 271, 286-287, 328, 474		
glass rimmer	409	milk jug	235, 269	skimmer	440, 445		
GN basket	16, 309, 312-314, 324	mini bowl	212, 220-221, 232-233, 235, 257, 269, 394, 416, 411	skimmer spoon	465		
GN basket metal	324	mixing glass	411	slate	24, 28, 87, 112-116, 120-121, 244, 249-250, 256		
GN basket polypropylene	16, 309, 312-314	Moscow Mule barrel mug	388-390	small serving pot	106, 232-233		
GN bowl melamine	153-154, 182, 224-225	mousse ring	468	snack dispenser	240, 393		
GN buffet display stainless steel	25-26, 28	muddler	402	snack tray	133, 425		
GN buffet ladder	80-81	multi rack stainless steel	95	snackbox	126-127, 230, 243		
GN buffet stand	157, 316	multibox	58	snackpresenter	92		
GN Chafing Dish	335-336, 338-339, 343-346	mussel pot	287	snap mesh tea ball	418		
GN cover	17, 99-100, 316, 318, 348, 484-487	mustard glass	261	soup ladle	441, 443, 445		
GN cutlery organizer	137-138, 312, 360, 367	<b>N</b>		soup pot	337, 345-346		
GN grid	360	napkin bag	277	spaghetti spoon	440		
GN natural slate tray	24, 250	napkin holder	139-141	spaghetti tong	445, 449		
GN pan stainless steel	100, 353-354	napkin rings	293	spatula	459		
GN partytray	108	natural slate tray	24, 87, 112-116, 120-121, 249-250, 256				
GN serving board	424	non slip mat	36, 383				
GN serving stand	17	oyster knife	458				
GN tray	15, 24, 153, 156, 159, 161, 166, 169-170, 173, 183, 185, 188, 193, 202, 204, 206-207	<b>P</b>					
GN tray melamine	24, 66, 153, 156, 159, 161, 166, 169-170, 173, 183, 185, 188, 193, 202, 204, 206-207	palm leaf melamine	176, 190, 214				
GN tray porcelain	15, 360	pan	102, 231-233				
GN tray stainless steel	15, 29, 99-101, 204	pan	102, 232-233				
		party spoon	200, 219-220, 240, 453				
		partytray	108				
		pastry spatula	459				
		pastry tongs	446-447, 450-451				
		pedal bin	431				



**artículos** **pág.**

<b>A</b>	
abridor	56, 413
adaptador	354, 356
aro anti-goteo melamina	37, 39, 384
aro de tarta	469
aro redondo para semifríos	468
artículos esmaltados	211, 270, 279-280, 287
azucarero	267-268, 417-418
<b>B</b>	
bajo plato	292
bandeja	14-15, 24, 27, 29, 35, 72, 83, 88, 94, 99-106, 109-111, 124-125, 131-133, 144, 146-148, 153, 156, 159-161, 163, 166, 169-174, 179, 183, 185-189, 192-194, 198, 200, 202, 204, 206-207, 210, 215, 217, 246, 251, 360, 421-423, 426
bandeja acero inoxidable	14-15, 34-35, 99-106, 109-111, 228, 251, 293, 420-422, 426
bandeja autoservicio y snacks	133
bandeja autoservicio y snacks	133, 425
bandeja con alturas	67-68, 82-87, 116, 186, 216
bandeja de pizarra natural	24, 87, 112-116, 120-121, 249-250, 256
bandeja isotérmica	30
bandeja madera	83, 88, 94, 107, 124-125, 132, 243, 246-247, 424
bandeja para sushi de madera	124, 247
bandeja para sushi melamina	147-148, 198
bandeja pastelera	251, 469
bandeja tartas acero inoxidable	105, 135, 289
bandeja tartas madera	122, 134-135, 288-289
bandeja tartas melamina	134, 216, 288
bandeja termo	35
bandejas refrigeradas	14, 27, 29
baño María	335-336, 338-340, 343-346, 348, 466
barra magnética para cuchillos	473
barreño botellines	55, 377
Bento Box	156-157
bolsa cubiertos	277
bolsa de almuerzo	322, 434
bolsa de servilletas	277
bomba dosificadora	477
bote	63-64
bote dosificador flexible	475-476
bote vertedor universal	368-369, 416
botella	52-53, 266, 281, 411, 413, 433, 475-476
botella de combustible líquido	350
botella exprimible	266, 411
botes especieros	258
brocha	272, 281
<b>C</b>	
caballetes buffet	20, 45, 304, 495
caballetes de mesa	300, 304
cacerola	102, 231-233
caddy de mesa	126, 128, 141, 246, 272-273
cafetera	415
caja comida	187
caja de buffet	70
caja de pan para buffet	88, 93, 318-319, 326-327
caja dispensadora	65
caja madera	128, 246, 272-273
caja para huevos	368, 477
caja para té	58
calentador de tetera	58
campana	14, 16-17, 94, 99-102, 104-107, 122, 136, 166, 170, 180, 217, 290, 316, 318, 348, 484-497
campana esférica	292, 426
campana rolltop	16-17, 25-30, 102, 112, 129, 217, 315, 348, 487
campana rolltop acero inoxidable	348
candelabro	274
cantimplora	433
carro	365
carro de servicio	360, 364-365
cazo recto bajo	233
cenicero	427-429
cenicero de pie	430
cepillo de limpieza	412
cesta acero inoxidable	234, 326-327
cesta de baguette	92, 310, 316
cesta de buffet	16, 93, 314-315, 319
cesta de cuerda de ganchillo	322
cesta de huevos	311
cesta metal	234, 323-325, 327-328
cesta para bollos	215
cesta para servir	234, 237
cesta polipropileno	294, 308-319
Chafing Dish	334-346
Chafing Dish Rolltop	348
champañera	376-378
coctelera	395-396
colador	400-401, 418, 463-464
colador cónico	464
colador de cóctel	400, 464
conjunto aperitivo	256, 259-266
corta huevos	462
corta pasta	461, 480
cortador de pizza	457, 462, 480
cupeta	15, 368
cubierta higiénica antialiento	84, 90, 93
cubitera	405
cubitera isotérmica	373, 405-406
cubitera para cava	55, 372-375, 377-378
cubitera para vino	55, 372-375, 377-378, 382
cubo	369
cuchara	218-220, 240, 399, 438-445, 453, 455, 465
cuchara de espaguetis	440
cuchara de miel	455
cuchara gourmet	240, 253
cuchara para ensalada	218, 438, 441, 454
cuchara para helado	474
cuchara para hornear	465
cuchara para servir	218, 438, 440-443, 445
cuchara party	200, 219-220
cucharilla de cóctel	399
cucharón	438, 440, 442-443, 445
cucharón de salsa/aliño	441, 453, 481
cucharón de sopa	441, 443, 445
cuchillo acanalador	401, 458
cuchillo de decoración cincelador	456
cuchillo para cóctel	401
cuchillo para untar	461
cuenco acero inoxidable	19, 102, 229, 232, 235-237, 327
cuenco aluminio	237, 323
cuenco de vidrio	77, 106
cuenco esmaltado	279-280, 287
cuenco hormigón	74
cuenco melamina	145-154, 156, 160, 162-165, 167-169, 172, 174, 176, 179, 181-186, 190-191, 194-199, 201-223, 493
cuenco mini	212, 220-221, 232-233, 235, 257, 269, 394, 416,
cuenco para chapas	56
cuenco para dip	196, 202, 213, 221, 223, 229, 237-239
<b>D</b>	
descorazonador	457
dispensador buffet en escalera	77, 78, 80-81, 93
dispensador de bebidas	36-40, 383-384
dispensador de bocadillos	92
dispensador de cereales	21, 59-62
dispensador de cereales acero inoxidable	21, 59-62
dispensador de film	473
dispensador de leche	20, 44-46, 235, 269, 414-416
dispensador de snacks	240, 393
dispensador de zumo	20, 41, 43-45
dispensador en escalera acero inoxidable	95
dispensador isotérmico	41
<b>E</b>	
embudo	369, 466, 471
embudo dosificador	466
enfriador de caviar	106, 271
enfriador múltiple	410
escurridor de fritos	465
espátula	439-440, 443-444, 459-460
espátula plancha	461
especiero	265
espumadera	440, 445
espumadera para fritos	465
estación de empanado	472
estación pan	88
esterilla antideslizante	36, 383
esterilla escurridora	409
etiquetas	297-299, 304, 495
expositor	108, 276
expositor buffet	93
expositor buffet frío	18, 28-30, 54, 112
expositor de buffet	61, 66, 69, 74-75, 91, 96-98, 118, 157, 184, 217, 287
expositor de buffet acero inoxidable	98
expositor de buffet madera	61, 66, 74-75, 98
expositor de buffet metal	69, 96-97, 118, 157, 184, 287
expositor para tartas	135, 289, 311
exprimidor cítricos	403, 472
<b>F</b>	
fiambreira	329, 435
flaneras	469
florero	275
fuelle en forma de hoja de palmera	
melamina	176, 190, 214
fuelle en forma de hoja melamina	176, 217, 490
fuelle para la mesa	102, 232-233
funda de frío	382
funda protectora	48
<b>G</b>	
GN bandeja	153, 156, 159, 161, 166, 169-170, 173, 183, 185, 188, 193, 202, 204, 206-207
GN bandeja acero inoxidable	15, 29, 99-101, 204
GN bandeja de pizarra natural	24, 250
GN bandeja melamina	24, 66, 153, 156, 159, 161, 166, 169-170, 173, 183, 185, 188, 193, 202, 204, 206-207
GN bandeja party	108
GN bandeja porcelana	15, 360
GN campana	17, 99-100, 316, 318, 348, 484-487
GN cesta	16, 309, 312-314, 324
GN cesta metal	324
GN cesta polipropileno	16, 309, 312-314
GN Chafing Dish	335-336, 338-339, 343-346
GN cubeta	15, 24
GN cubeta acero inoxidable	100, 353-354
GN cuenco melamina	153-154, 182, 224-225
GN dispensador buffet en escalera	80-81
GN escurridor	356, 358
GN expositor buffet acero inoxidable	25-28

GN porta cubiertos	137-138, 312, 360, 367
GN rejilla	360
GN soporte buffet	17, 316
GN soporte para buffet	157
GN tapa	225, 355-358, 362
granulado térmico	351
<b>H</b>	
hormigón	141, 168, 260, 272, 274-275, 298, 381, 384
huevo	218, 270
<b>I</b>	
infusor de té, pinza con malla	418
<b>J</b>	
jarra	45-50, 52-54, 57, 235, 269, 380, 414-416, 419
jarra de agua	50, 52-53
jarra de leche	235, 269
jarra de vidrio	50-53
jarra de zumo	50, 52-53
jarra enfriadora	50
jarra graduada	467-468
jarra termo	47-49
juego de cucharas medidoras	451
<b>L</b>	
llavero enrollable	410
<b>M</b>	
mandolina	466
manoplas de panadero	478
mantelín	276-278
mantequera	270
mantequillera	270
marco de acero inoxidable para placa de inducción	336-338, 349
marco pastelero	469, 478-479
marmita	337, 345-346
medidor jigger	397, 398
mejillonera	287
molde de cubitos de hielo esféricos	404
molde de pizza	478-480
molde para cubitos de hielo	404
molinillo de pimienta	252-258, 266, 465
molinillo de sal	252-258, 266, 465
mortero	402
Moscow Mule taza	388-390
<b>O</b>	
organizador de bar	409
<b>P</b>	
pajas	408
pala	248, 454-455
pala de hielo	406
pala de pizza	479
pala de tartas	439, 441
pala para harina	470, 481
paleta para servir	230, 441
paleta pastelera	459
panera	320-322
papel alimenticio	111, 114, 126, 236, 251, 420
papelera de sobremesa	295-296
pelador reversible	457
picadora de hielo	406
pie porta champañera / vino	374
pie porta vino	374
pinchanotas	473
pinza	407, 445-452
pinza bogavante	462
pinza de emplatar	407, 452
pinza ensalada	445-449
pinza exprime limón	418
pinza para aperitivos	449
pinza para cubitos de hielo	407
pinza para pasteles	446-447, 450-451
pinza universal	446
pizarra	24, 28, 87, 112-116, 120-121, 244, 249-250, 256

placa de inducción	76, 334, 336-338, 340-341, 349	tapa hermética	19, 286
plato esmaltado	279	tapete escurridor	409
plato melamina	144, 146-148, 160, 162, 164, 175, 192, 194, 198, 204, 208, 217, 222	tapón antipolvo	410
plato para el aperitivo	204	tapón vertedor	412
polvoreador	257-258, 465	tartetas	298-301
porcelana	46, 338, 340	tarros gourmet	285
porcionador de pastel	439	taza	39-40, 123, 218, 240, 270, 280, 305, 385, 387-396, 427-432, 434, 467-468, 497
porta cubiertos	21, 137-138, 295, 312, 366-367	taza de café	280, 305, 432
porta cubiertos	294, 317	tenedor de carne	439, 442-443
porta cuenta	293, 426	tenedor de ensalada	438, 441, 454
porta menú	297-302	termómetro	415
porta vasos de cerveza	131, 423	tetera ASIA	57, 419
portafichas	473	timbre	426
porta-tartetas	297-302	tubo enfriador para cubitos	36, 52-53, 383
portavelas antiviento	274	<b>V</b>	
posavasos acero inoxidable	293	vaciador de melón redondo	456
posavasos pizarra natural	114, 250, 256	vaso	38, 386
prensa de limón	403, 472	vaso agitador	468
<b>R</b>		vaso coctelero	280
rack de copas	392	vaso mezclador vertedor	411
rack dispensador de cuencos	79	vaso para servir	232-239
rebanador de queso	458	vaso reutilizable	305, 432, 497
recipiente de ingredientes	401	vaso To-Go	305, 432, 497
recipiente organizador	294-296, 312, 368, 401	vasos	39-40, 385, 387
recipiente para masa	368, 480	vertedor continuo	412
recogemigas	292, 426	vertedores	50-51, 260-263, 265-266, 369, 400, 411-412, 470
reposa cuchara	218, 351	vitrina de buffet	25-28, 34
resistencia	47, 348-350	vitrina de buffet acero inoxidable	25-26, 28, 34
ribeteador de vasos	409	<b>W</b>	
rizador	84, 458, 466	Weck-botellas	65, 282-286
rotulador de tiza	304		
<b>S</b>			
sacacorchos	413		
sacacorchos de camarero	413		
salsera	291-292		
salsera acero inoxidable	73		
salsera melamina	73		
salsera porcelana	73		
sartén de hierro fundido	231		
Servidor de ensalada	438, 454		
servilletero	139-141		
servilleteros/aros	293		
set de buffet	93		
set de buffet refrigerado	18, 112		
set para fondue	271, 347		
set para servir	150-151		
set rolltop	30, 106, 115		
snackbox	126-127, 230, 243		
soplete de cocina para flambeo	474		
soporte	61, 66, 69, 74-75, 84, 96-98, 157, 179-180, 184, 216-217, 271, 287, 328, 474		
soporte a pedal	431		
soporte campana	94		
soporte cucurucho	474		
soporte de pretzels o salchichas	84		
soporte para botella de vino	382		
soporte para brochetas	274		
soporte para pastel	105, 115, 122, 131-135, 216, 288-289		
soporte para tablas de cortar	474		
soporte platos	79, 84-86, 286		
superbox	21-24, 330-331		
<b>T</b>			
tabla de corte	59, 88, 130		
tabla de servir	83, 119-126, 128-129, 242-249		
tabla para cortar	15, 88-89, 130, 401		
tabla para el buffet	52, 117-118, 129		
tapa	65, 77, 209-210, 214, 225, 286, 355-358, 480, 493-495		
tapa acero inoxidable	355-356		

## FRANÇAIS

item	pág.
<b>A</b>	
accumulateur de froid	27-34, 42, 496
adaptateur	354, 356
anneaux à serviettes	293
ardoise	24, 28, 87, 112-116, 120-121, 244, 249-250, 256
articles en email	211, 270, 279-280, 287
assiette de présentation	292
assiette email	279
assiette mélamine	144, 146-148, 160, 162, 164, 175, 192, 194, 198, 204, 208, 217, 222
assiette pour apéritif	204
<b>B</b>	
Bain-Marie	335-336, 338-340, 343-346, 348, 466
barre aimantée pour couteaux	473
barre porte-bons	473
base bois	128, 246, 272-273
bassine à glace	55, 377
Bento Box	156-157
béton	141, 168, 260, 272, 274-275, 298, 381, 384
beurrer	270
boîte à lunch	329, 435
boîte à œufs	368, 477
boîte à pain pour le buffet	88, 93, 318-319, 326-327
boîte à thés et infusions	58
boîte de buffet	70
boîte-repas	187
bol acier inox	19, 102, 229, 232, 235-237, 327
bol aluminium	237, 323
bol béton	74
bol bois	69, 119, 127-128, 241-242, 495
bol email	279-280, 287
bol en verre	77, 106
bol mélamine	145-154, 156, 160, 162-165, 167-169, 172, 174, 176, 179, 181-186, 190-191, 194-199, 201-223, 493
bol mélangeur	280
bol mini	212, 220-221, 232-233, 235, 257, 269, 394, 416,
bol récupérateur de capsules	56
bol réfrigéré	19, 31-33
bordeur à verres	409
bouchon anti-poussières et anti-insectes	410
bouchons verseurs	50-51, 260-263, 265-266, 369, 400, 411-412, 470
boule à thé avec pince	418
bouteille	52-53, 266, 281, 411, 413, 433, 475-476
bouteille store & pour	411, 475-476
bouteille de combustible liquide	350
bouteille isotherme	47-49
bouteille verseuse souple	475-476
brosse lave	412
broyeur à glaçons	406
<b>C</b>	
caddy	126, 141, 246, 272-273, 296, 409
caddy de table	126, 128, 141, 246, 272-273
cadre support inox pour plaque induction	336-338, 349
caisson thermo	35
carafe en verre	50-53
casserole	102, 231-233
casserole à moules	287
cendrier	427-430
cendrier sur pied	430
cercle à gâteaux	469
cercle à mousse rond	468
Chafing Dish	334-346
Chafing Dish Rolltop	348
chalumbeau e cuisine	474
chandelier	274
chariot	365
chariot de service	360, 364-365
chauffe-plat	350
chauffe-théière	58
chevalets de table	300, 304
chinois	464
cloche	14, 16-17, 94, 99-102, 104-107, 122, 136, 166, 170, 180, 217, 290, 316, 318, 348, 484-497
cloche demi-sphère	292, 426
cloche rolltop	16-17, 25-30, 102, 112, 129, 217, 315, 348, 487
cloche rolltop acier inox	348
coquetier	218, 270
corbeille	320-322
corbeille à baquette	92, 310, 316
corbeille à petits pains	215
corbeille acier inox	234, 326-327
corbeille de buffet	16, 93, 314-315, 319
corbeille de service	234, 237
corbeille métal	234, 323-325, 327-328
corbeille polypropylène	294, 308-319
coupe-œufs	462
coupe-pâte	461, 480
coupe-pizza	457, 462, 480
couteau à huitres	458
couteau à tarte	439
couteau à tartiner	461
couteau cannelé	401, 458
couteau cocktail	401
couteau tranche-fromage	458
couteau zesteur	456
couvercle	65, 77, 209-210, 214, 225, 286, 355-358, 480, 493-495
couvercle acier inox	355-356
couvercle hermétique	19, 286
couvert à salade	438, 454
cuillère	218-220, 240, 399, 438-445, 453, 455, 465
cuillère à cocktail	399
cuillère à glace	474
cuillère à miel	455
cuillère à salade	218, 438, 441, 454
cuillère à sauce	441, 453, 481
cuillère à spaghettis	440
cuillère de service	218, 438, 440-443, 445
cuillère gourmet	240, 453
cuillère party	200, 219-220
cuillère party	2000, 219-220
cuillère pâtisserie	465
<b>D</b>	
décapsulateur	56, 413
dénoyauteur	457
dérouleur de film	473
distributeur de petits pains acier inox	93
distributeur à jus	20, 41, 43-45
distributeur à lait	20, 44-46, 235, 269, 414-416
distributeur de boisson isothermique	41
distributeur de boissons	36-40, 383-384
distributeur de café acier inox	47, 348
distributeur de céréales	21, 59-62
distributeur de céréales acero inox	21, 59-62
distributeur de snacks	240, 393
doseur à sauce	477
<b>E</b>	
écumoire	440, 445
égouttoir à friture	465
entonnoir à piston	466
étagère	67-68, 82-87, 116, 186, 216
étiquettes	297-301, 304, 495
<b>F</b>	
flacon pulvérisateur	266, 411

forme à gateaux	469, 478-479	pelle à gâteaux	439, 441	pot à épices	257-258, 465	tapis égouttoir	409
fouet	462	pelle à glaçons	406	pot à sauce acier inox	73	tasse à café	280, 305, 432
fourchette à salade	438, 441, 454	pelle à pizza	479	pot à sauce mélamine	73	tasse à remuer	468
fourchette à viande	439, 442-443	petits chevaux de buffet	20, 45, 304, 495	pot à sauce porcelaine	73	tasse réutilisable	305, 432, 497
fourchette de service	438-439, 442-443, 453	pichet	45-50, 52-54, 57, 235, 269, 380, 414-416, 419	pot de moutarde	261	tasse To-Go	305, 432, 497
frisette	84, 458, 466	pichet à café	415	pot verseur universel	368-369, 416	théière ASIA	57, 419
<b>G</b>		pichet à jus de fruit	50, 52-53	poubelle de table	295-296	thermomètre	415
gants de boulanger	478	pichet à lait	235, 269	présentoir à assiettes	79, 84-86, 286	tire-bouchons	413
GN bac	15, 24, 100, 224-225, 353-354, 357-359, 361-363	pichet gradué	467-468	présentoir à gâteaux	105, 115, 122, 134-135, 216, 288-289, 311	truille de service	230, 441
GN bac acier inoxydable	100, 353-354	pichet rafraîchisseur	50	présentoir à sandwiches	92	tube pour glaçons	36, 52-53, 383
GN bol mélamine	153-154, 182, 224-225	piéd pour seau à champagne / vin	374	présentoir buffet	61, 66, 69, 74-75, 91, 93, 96-98, 118, 157, 184, 217, 287	<b>V</b>	
GN Chafing Dish	335-336, 338-339, 343-346	pilon muddler	402	présentoir buffet acier inox	98	verre mélangeur	411
GN cloche	17, 99-100, 316, 318, 348, 484-487	pince à asperges	486	présentoir buffet bois	61, 66, 74-75, 98	verres gourmet	285
GN corbeille	16, 309, 312-314, 324	pince à dresser	407, 452	présentoir buffet en escalier	77, 78, 80-81, 93	verseurs continus	412
GN corbeille métal	324	pince à gâteaux	446-447, 450-451			vitrine de buffet	25-28, 34
GN corbeille polypropylène	16, 309, 312-314	pince à glaçons	407			vitrine de buffet acier inox	25-26, 28, 34
GN couvercle	225, 355-358, 362	pince à homard	462				
GN égouttoir	356, 358	pince à salade	445-449				
GN grille	360	pince à spaghetti	445, 449				
GN planche de service	424	pince universelle	446				
GN plateau	153, 156, 159, 161, 166, 169-170, 173, 183, 185, 188, 193, 202, 204, 206-207	pinceau pâtissier	272, 281				
GN plateau acier inox	15, 29, 99-101, 204	pique-bons	473				
GN plateau ardoise naturelle	24, 250	planche à découper	15, 59, 88-89, 130, 401				
GN plateau buffet acier inox	25-26, 28	planche à découper buffet	52, 117-118, 129				
GN plateau mélamine	24, 66, 153, 156, 159, 161, 166, 169-170, 173, 183, 185, 188, 193, 202, 204, 206-207	planche de service	83, 119-126, 128-129, 242-249				
GN plateau party	108	plaque à induction	76, 334, 336-338, 340-341, 349				
GN plateau porcelaine	15, 360	plaque à pâtisserie	251, 469				
GN présentoir buffet	157, 316	plaque à pâtisserie	111, 251, 360				
GN présentoir buffet en escalier	80-81	plat à gâteau acier inox	105, 135, 289				
GN range couverts	137-138, 312, 360, 367	plat à gâteau bois	122, 134-135, 288-289				
GN support buffet	17	plat à gâteau mélamine	134, 216, 288				
gobelet	39-40, 123, 218, 240, 270, 280, 305, 385, 387-396, 427-432, 434, 467-468, 497	plat à sauter	233				
gobelet à apéritif	232-239	plat ardoise naturelle	24, 87, 112-116, 120-121, 249-250, 256				
<b>H</b>		plat pour la table	102, 232-233				
housse de protection	48	plateau	14-15, 24, 27, 29, 35, 72, 83, 88, 94, 99-106, 109-111, 124-125, 131-133, 144, 146-148, 153, 156, 159-161, 163, 166, 169-174, 179, 183, 185-189, 192-194, 198, 200, 202, 204, 206-207, 210, 215, 217, 246, 251, 360, 421-424, 426				
housse isotherme	382	plateau acier inox	14-15, 34-35, 99-106, 109-111, 228, 251, 293, 420-422, 426				
<b>J</b>		plateau bois	83, 88, 94, 107, 124-125, 132, 243, 246-247, 424				
jeu de cuillère à mesure	451	plateau feuille de palme mélamine	176, 190, 214				
<b>L</b>		plateau feuille mélamine	176, 217, 490				
louche	438, 440, 442-443, 445	plateau mélamine	83, 88, 144, 146-148, 153, 156, 159-161, 163, 166, 169-174, 179, 183, 185-189, 192-194, 198, 200, 202, 204, 206-207, 210, 215, 217, 363				
louche de service	441, 443, 445	plateau party	108				
<b>M</b>		plateau self-service et snacks	133, 425				
mandoline	466	plateau sushi en bois	124, 247				
marmite	337, 345-346	plateau sushi mélamine	147-148, 198				
marmite petite de servir	106, 232-233	plateaux réfrigérés	14, 27, 29				
marqueur à la craie liquide	304	plucheur droitier/gaucher	457				
mesure jigger	397, 398	pochette à serviettes	277				
Moscow Mule gobelet	388-390	pochette couverts	277				
moule à boule ronde simple	456	poêle en fonte	231				
moule à glaçons	404	pompe de dosage	477				
moule à glaçons en boules	404	porcelaine	46, 338, 340				
moule à pizza	478-480	porte verres à bière	131, 423				
moules à flan	469	porte-addition	293, 426				
moulin à poivre	252-257, 266, 465	porte-bols	79				
moulin à sel	252-258, 266, 465	porte-bouteille à vin	382				
multibox	58	porte-cartes	297-302				
<b>N</b>		porte-clés avec câble à enroulement	410				
organisateur bar caddy	409	porte-épices	265				
<b>P</b>		porte-épices	265				
panier à œufs	311	porte-serviettes	139-141				
panier en corde au crochet	322	pose-cuillère	218, 351				
panier pour le service sur table	114, 234						
pare-haleine	84, 90, 93						
passoire	463-464						
peleur	456						
pelle	248, 454-455						
pelle à farine	470, 481						





# Buffet & Display

FRAMES .....	14
BRIDGE .....	18
SUPERBOX .....	22
COOLING DISPLAYS .....	25
BEVERAGE DISPENSERS .....	36
VACUUM JUGS .....	48
CARAFES .....	50
BEVERAGE BOWLS .....	54
TEAPOTS .....	57
CEREAL DISPENSERS .....	59
CANISTERS .....	63
BUFFET DISPLAY .....	66
ETAGERES .....	82
CUTTING BOARDS .....	88
BUFFET GUARDS   SHOWCASES .....	90
MULTI RACKS .....	95
BUFFET STANDS .....	96
TRAYS   BOARDS .....	99
SERVING BOARDS   NATURAL SLATE .....	112
SERVING BOARDS   WOOD .....	117
TRAYS .....	131
FAST FOOD TRAYS .....	133
CAKE STANDS .....	134
SUPER DOME .....	136
CUTLERY BOXES .....	137
NAPKIN HOLDERS .....	139

# FRAMES



Die reduzierte, archetypische Formsprache von FRAMES nimmt sich elegant zurück und lässt damit viel Raum für die Inszenierung der Buffet-Speisen. Ein scheinbarer Widerspruch löst sich auf: das Design ist zeitgemäß und zeitlos zugleich.

Design in detail – The classic minimalist visual style of FRAMES is elegantly understated, leaving plenty of potential for creating appealing buffet arrangements. Its design transcends what at first seems to be an irreconcilable paradox, being at once both timeless and highly contemporary.

Diseño en detalle - El estilo visual clásico y minimalista de FRAMES es elegantemente sobrio, dejando mucho potencial para crear atractivas composiciones para el buffet. Su diseño supera lo que a primera vista parece una paradoja irreconciliable, siendo a la vez intemporal y muy contemporáneo.

Le design dans le détail - Le style visuel minimaliste classique de FRAMES est élégamment discret, laissant beaucoup de potentiel pour créer des arrangements de buffet attrayants. Son design transcende ce qui semble à première vue être un paradoxe irréconciliable, étant à la fois intemporel et très contemporain.



## Kühltablets SET 1 „FRAMES“

cooling plates  
bandejas refrigeradas  
plateaux réfrigérés



GN 1/1 Basiselement, GN 1/1 Edelstahl Tablett 18/10, Kühlakku  
GN 1/1 base element, GN 1/1 stainless steel platter 18/10, cooler  
elemento básico GN 1/1, bandeja GN 1/1 de acero inoxidable 18/10, acumulador de frío  
élément de base GN 1/1, plateau GN 1/1 en acier inox 18/10, accumulateur de froid

	cm	↑ cm	GN	Farbe / Colour	
12940	53 x 32,5	8,5	1/1		stainless steel
14940	53 x 32,5	8,5	1/1		wenge wood
13940	53 x 32,5	8,5	1/1		maple wood



## Kühltablets SET 2 „FRAMES“

cooling plates  
bandejas refrigeradas  
plateaux réfrigérés



GN 1/1 Basiselement, GN 1/1 Edelstahl Tablett 18/10, Rolltophaube, Kühlakku  
GN 1/1 base element, GN 1/1 stainless steel platter, rolltop cover, cooler  
elemento básico GN 1/1, bandeja GN 1/1 de acero inoxidable 18/10, campana rolltop, acumulador de frío  
élément de base GN 1/1, plateau GN 1/1 en acier inox 18/10, cloche rolltop, accumulateur de froid

	cm	↑ cm	GN	Farbe / Colour	
12941	53 x 32,5	27,5	1/1		stainless steel
14941	53 x 32,5	27,5	1/1		wenge wood
13941	53 x 32,5	27,5	1/1		maple wood

**Schneidebrett „FRAMES“**

cutting board  
tabla de cortar  
planche à découper

**Ahorn, massiv**  
maple wood, solid  
madera de arce, maciza  
bois d'érable, massif



	cm	↑ cm	GN
13955	53 x 32,5	2,5	1/1

**Schneidebrett „FRAMES“**

cutting board  
tabla de cortar  
planche à découper



	cm	↑ cm	GN
17910	53 x 32,5	2,5	1/1

**GN Tablett „FRAMES“**

GN tray  
GN bandeja  
GN plateau



	cm	↑ cm	GN
82355	53,0 x 32,5	2	1/1
82356	32,5 x 26,5	2	1/2
82357	32,5 x 17,6	2	1/3

**GN Edelstahl Tablett „FRAMES“**

GN stainless steel platter  
GN bandeja acero inoxidable  
GN plateau acier inox



	cm	↑ cm	GN
11119	53,0 x 32,5	2	1/1
11118	32,5 x 26,5	2	1/2

**GN Tablett „FRAMES“**

GN tray  
GN bandeja  
GN plateau

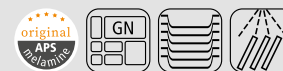

	cm	↑ cm	GN
84046	53,0 x 32,5	2	1/1
84047	32,5 x 26,5	2	1/2
84048	32,5 x 17,6	2	1/3

**GN Wanne „FRAMES“**

GN tray  
GN bandeja  
GN plateau



	cm	↑ cm	GN
17922	53 x 32,5	8	1/1

## FRAMES



### Korb „GN LINE“

GN basket

GN cesta

GN corbeille



**stabile Ausführung mit Edelstahldraht im Rand zur Stabilisierung**

very solid with stainless steel wire frame to stabilize the basket

muy resistente con alambre de acero inoxidable en el borde para la estabilización

très résistante avec fil d'acier inox dans le bord pour la stabilisation

	cm	↑ cm	GN
40291	53,0 x 32,5	6,5	1/1
40290	32,5 x 26,5	6,5	1/2
40293	53,0 x 32,5	10,0	1/1
40292	32,5 x 26,5	10,0	1/2



### Buffetkorb „ECONOMIC“

basket

cesta

corbeille

**Polyrattan, mit Haubenschiene (ohne Haube)**

polyrattan, with frame to fix the cover (without cover)

polyrattan, con fijación para campana (sin campana)

polyrattan, avec fixation pour la cloche (sans cloche)



	cm	↑ cm
40294	56,5 x 36,0	10



### Buffetkorb „ECONOMIC“

buffet basket

cesta de buffet

corbeille de buffet

**Polyrattan, mit Haubenschiene (ohne Haube)**

polyrattan, with frame to fix the cover (without cover)

polyrattan, con fijación para campana (sin campana)

polyrattan, avec fixation pour la cloche (sans cloche)



	Ø cm	↑ cm
40295	40	12,5



### Rolltophaube

rolltop cover

campana abatible

cloche basculante



	Ø cm	↑ cm
18389	38	20



### Eisbox „FRAMES“

ice box

bandeja para hielo

caisse à glaçons

**3-teilig: 1 Basiselement Wenge + 1 Polystyrolwanne + 1 Tropfgitter**

3 pcs. set: 1 box wenge + 1 plastic deep tray + 1 drainer plate

set de 3: 1 cajón color wengué + 1 cubeta plástico + 1 rejilla

set de 3: 1 caisson couleur wengé + 1 bac plastique + 1 plaque perforée



	cm	↑ cm	GN	Farbe / Colour
14970	53 x 32,5	12,5	1/1	■





**vielseitig einsetzbar für alle GN 1/1 Artikel**



11008  
2x 85146  
GN 1/2

**passendes Kühltablett Set**

**Gestell für GN 1/1 „FRAMES“**

serving stand GN 1/1  
soporte para GN 1/1  
support pour GN 1/1

**Buche massiv, Wenge**  
solid beech, colour wenge  
haya maciza, color wengué  
hêtre massif, couleur wengé



	cm	↑ cm	Farbe / Colour
14953	57,5 x 27,5	22	



84047  
GN 1/2

84047  
GN 1/2

**passendes Kühltablett Set**



14956

14953

**passende Besteck / Universal-Box GN 1/1**



14954

**Einsatz / insert**

**Besteck- / Universal-Box, 2-teilig „FRAMES“**

cutlery tray, 2 pcs.  
cubertero o cajón multi-usos, set de 2  
caisson à couverts ou multi-usages, set de 2

**Buche massiv, Wenge, 4 Fächer, inklusive herausnehmbaren Einsatz**  
solid beech, colour wenge, 4 compartments, including removable insert  
haya maciza, color wengué, 4 compartimentos, con separador extraíble  
hêtre massif, couleur wengé, 4 compartiments, avec insert amovible



	cm	↑ cm	GN	Farbe / Colour
14956	53 x 32,5	11	1/1	

**Einsatz für GN 1/1 „FRAMES“ / insert for GN1/1 / separador para GN1/1 / insert pour GN1/1**

	cm	↑ cm	Farbe / Colour
14954	48,5 x 28	8	



**GN 1/1 Rolltophaube**

GN 1/1 rolltop cover  
GN 1/1 campana abatible  
GN 1/1 cloche basculante

**verchromter Zinkdruckguss-Griff**  
chrome plated metal handle  
mango cromado de fundición a presión de zinc  
poignée en zinc moulé sous pression chromé



	cm	↑ cm	GN
11018	53 x 32,5	17	1/1



**GN 1/1 Rolltophaube**

GN 1/1 rolltop cover  
GN 1/1 campana abatible  
GN 1/1 cloche basculante

**patentiert, passend für GN-Behälter, -Tablets, etc., leichtgängig auf- und zuklappbar 90°**  
patented, suitable for GN containers, trays, etc., solid quality, 90° opening  
patentada, para contenedores, bandejas GN, apertura 90°  
breveté, pour bacs, plateaux GN, ouverture 90°



	cm	↑ cm	GN
11008	53 x 32,5	17	1/1



# BRIDGE

Mit hohem Anspruch an Design und Funktionalität haben wir das Buffet-System „Bridge“ für Sie entwickelt. Die in den Holzoberflächen Ahorn und Wenge erhältlichen Artikel sind in ihren Höhen und ihren Volumina optimal aufeinander abgestimmt und gewährleisten einen einfachen und sicheren Umgang in Ihrem Gastronomiealltag.

The collection "Bridge" is bringing perfectly coordinated components for an uncomplicated and organized buffet system, finalizing in a unique buffet scenery. All pieces combine perfectly with one another in their variations of sizes and volumes. The wooden items are available in 2 colors, maple or wenge. A simple and safe handling is guaranteed.

Una colección universal para un buffet único: un Sistema funcional y fácil de componer, asociado a la elegancia de su exclusivo diseño. Los elementos se combinan a la perfección entre variaciones de Alturas y volúmenes, realizando sus propuestas y composiciones culinarias y modelando el paisaje del buffet. Las piezas están disponibles en 2 colores, wengué o arce. Manejo sencillo y seguro.

Une collection universelle pour une présentation unique de votre buffet: fonctionnel et facile à composer, ce système est à la fois pratique, simple et spectaculaire par son élégant design. Les différents éléments se marient à la perfection pour construire sans difficulté différentes compositions, variant les hauteurs et les volumes et mettant en valeur vos créations culinaires. Les pièces sont disponibles en deux couleurs, bois wengé ou érable.



## Kühlbox „BRIDGE“ refrigerated buffet display set de buffet refrigerado présentoir buffet froid



Set bestehend aus: 1 Gestell aus Ahorn oder Wenge, 1 Behälter aus Kunststoff, 1 GN1/1 Tablett aus Melamin, 1 Kühlakku, 1 Rolltophaube (fix montiert)

set consists of: 1 base element maple or wenge, 1 plastic insert black, 1 GN1/1 tray melamine, 1 cooler, 1 cover (fixed)

set compuesto por: 1 soporte de madera arce o wengué, 1 cubeta de plástico, 1 bandeja de melamina GN 1/1, 1 acumulador de frío, 1 campana rolltop (fija)

set composé de: 1 support en bois érable ou wengé, 1 bac plastique, 1 plat en mélamine GN 1/1, 1 accumulateur de froid, 1 cloche rolltop (fixe)

	cm	↑ cm	Farbe / Colour	
13990	63,5 x 42,5	31		ahorn wood
14990	63,5 x 42,5	31		wenge wood

**Kühlschale „BRIDGE“**cooling bowl  
bol refrigerado  
bol réfrigéré4-teilig: 1 Gestell aus Ahorn oder Wenge, 1 Behälter aus Edelstahl,  
1 Schale aus Melamin (Ø 14 cm o. 23 cm), 1 Kühlakku4 pcs.: 1 base element maple or wenge, 1 bowl stainless steel,  
1 bowl melamine (Ø 14 or 23 cm), 1 coolerset de 4: 1 soporte de madera arce o wengué, 1 cuenco  
de acero inoxidable, 1 cuenco de melamina (Ø 14 cm o 23 cm), 1 acumulador de fríoset de 4: 1 support en bois érable ou wengé, 1 bol en acier inox, 1 bol en mélamine  
(Ø 14 cm ou 23 cm), 1 accumulateur de froid

	cm	↑ cm	ltr.	Farbe / Colour
13980	18,5 x 18,5	10	0,5	
13981	27,5 x 27,5	14	2,5	

	cm	↑ cm	ltr.	Farbe / Colour
14980	18,5 x 18,5	10	0,5	
14981	27,5 x 27,5	14	2,5	

**Edelstahlschale „BRIDGE“**stainless steel bowl  
cuenco acero inoxidable  
bol acier inox

	Ø cm	↑ cm
30050	14	8,5
30052	23	13,5

**Schale „CASUAL MAXI“**bowl  
cuenco  
bol

	Ø cm	↑ cm	ltr.	Farbe / Colour
83700	14	6,5	0,5	
83702	23	10,5	2,5	

	Ø cm	↑ cm	ltr.	Farbe / Colour
83701	14	6,5	0,5	
83703	23	10,5	2,5	

**Frischhaltedeckel**airtight cover  
tapa hermética  
couvre-cle hermétique

	Ø cm
10890	14
10887	23

Kühlakku / cooler / acumulador de frío / accumulateur de froid

	Ø cm	↑ cm
10661	10,5	2,0
10777	15,0	2,5



Milchdispenser „BRIDGE“

milk dispenser  
dispensador de leche  
distributeur à lait



Edelstahl Dispenser mit 1 Kühllakku im Standfuß inklusive touchless adapter

stainless steel dispenser with 1 cooling element in stand including touchless adapter  
dispensador de acero inoxidable con 1 acumulador de frío en la base y con adaptador sin contacto para grifo  
distributeur en acier inox avec 1 accumulateur de froid dans le socle et avec adaptateur sans contact manuel

	cm	↑ cm	ltr.	Farbe / Colour
10836	31 x 20	39	3	Ahorn / maple
10838	39 x 22	45	5	Ahorn / maple



Milchdispenser „BRIDGE“

milk dispenser  
dispensador de leche  
distributeur à lait



Edelstahl Dispenser mit 1 Kühllakku im Standfuß inklusive touchless adapter

stainless steel dispenser with 1 cooling element in stand including touchless adapter  
dispensador de acero inoxidable con 1 acumulador de frío en la base y con adaptador sin contacto para grifo  
distributeur en acier inox avec 1 accumulateur de froid dans le socle et avec adaptateur sans contact manuel

	cm	↑ cm	ltr.	Farbe / Colour
10837	31 x 20	39	3	Buche / beech
10839	39 x 22	45	5	Buche / beech



Saftdispenser „BRIDGE“

juice dispenser  
dispensador de zumo  
distributeur à jus



Kühlung durch 2 Kühllakkus von oben und unten

cooling with 2 cooling elements from the top and base  
2 acumuladores de frío: 1 en la base y 1 en la tapa  
2 accumulateurs de froid: 1 dans le couvercle et 1 dans le socle

	cm	↑ cm	ltr.	Farbe / Colour
10870	31,0 x 20	42	4	Ahorn / maple
10871	35,5 x 22	50	6	Ahorn / maple

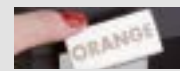

inklusive 3 Magnetschilder: ORANGE, APPLE, GRAPEFRUIT  
including 3 magnetic signs: ORANGE, APPLE, GRAPEFRUIT



Saftdispenser „BRIDGE“

juice dispenser  
dispensador de zumo  
distributeur à jus



Kühlung durch 2 Kühllakkus von oben und unten

cooling with 2 cooling elements from the top and base  
2 acumuladores de frío: 1 en la base y 1 en la tapa  
2 accumulateurs de froid: 1 dans le couvercle et 1 dans le socle

	cm	↑ cm	ltr.	Farbe / Colour
10872	31,0 x 20	42	4	Wenge / wenge
10873	35,5 x 22	50	6	Wenge / wenge



inklusive 3 Magnetschilder: ORANGE, APPLE, GRAPEFRUIT  
including 3 magnetic signs: ORANGE, APPLE, GRAPEFRUIT



### Cerealispender „BRIDGE“

cereal dispenser  
dispensador de cereales  
distributeur de céréales



**Behälter herausnehmbar, „Feierabend-Deckel“ für das aromadichte Lagern, Portionieren durch einfaches Drehen**

removable canister, special lid to keep the cereals fresh, easy to use, rotate the button to get the muesli

contenedor extraíble, tapa especial para mantener los cereales frescos, fácil de usar, se gira el pomo para servir los cereales

réceptif amovible, couvercle spécial pour conserver les céréales, usage facile en tournant le bouton

	cm	↑ cm	ltr.	Farbe / Colour	
13987	21 x 20	55,5	4,5		Ahorn / maple



### Cerealispender „BRIDGE“

cereal dispenser  
dispensador de cereales  
distributeur de céréales



**Behälter herausnehmbar, „Feierabend-Deckel“ für das aromadichte Lagern, Portionieren durch einfaches Drehen**

removable canister, special lid to keep the cereals fresh, easy to use, rotate the button to get the muesli

contenedor movible, tapa especial para mantener los cereales frescos, fácil de usar, se gira el pomo para servir los cereales

réceptif amovible, couvercle spécial pour conserver les céréales, usage facile en tournant le bouton

	cm	↑ cm	ltr.	Farbe / Colour	
14987	21 x 20	55,5	4,5		Buche / beech



### Besteckbehälter „BRIDGE“

cutlery organizer  
cajón para cubiertos  
bac à couverts



**2 teiliges Set: 1 Gestell, 1 Besteckbehälter (Nr. 11955), herausnehmbar**

2 pcs.: 1 base element, 1 removable plastic container (item 11955)

set de 2: 1 soporte, 1 cajón para cubiertos (ref. 11955) extraíble

set de 2: 1 support, 1 bac à couverts (réf. 11955) amovible

	cm	↑ cm	Farbe / Colour	
13995	57,5 x 37	12		Ahorn / maple



### Besteckbehälter „BRIDGE“

cutlery organizer  
cajón para cubiertos  
bac à couverts



**2 teiliges Set: 1 Gestell, 1 Besteckbehälter (Nr. 11955), herausnehmbar**

2 pcs.: 1 base element, 1 removable plastic container (item 11955)

set de 2: 1 soporte, 1 cajón para cubiertos (ref. 11955) extraíble

set de 2: 1 support, 1 bac à couverts (réf. 11955) amovible

	cm	↑ cm	Farbe / Colour	
14995	57,7 x 37	12		Buche / beech



Die stapelbaren Wendeböden lassen sich rutschfest stapeln und mit flachen GN Platten verbinden und einzeln nutzen. Individuell können Buffet-landschaften gebaut werden.

The stackable and non-slip reversible boxes can be connected to flat GN trays and can also be used individually. Different and individual buffet sceneries can be built up.

Las cajas girables y apilables son antideslizantes y se pueden conectar con bandejas planas GN o utilizar individualmente. Se pueden construir diferentes paisajes de buffet muy individuales.

Les boîtes de tournage empilables sont antiglissantes et peuvent être connectées avec des plateaux plats GN ou utilisées individuellement. Des paysages de buffet très personnalisés peuvent être construits.



GN 1/1 „SUPERBOX“



Akazienholz / acacia wood / madera de acacia / bois d'acacia

	cm	↑ cm	GN	Farbe / Colour
11620	55,5 x 35,0	10,5	1/1	
11626	55,5 x 35,0	10,5	1/1	
11721	55,5 x 35,0	20,0	1/1	
11723	55,5 x 35,0	20,0	1/1	



GN 2/4 „SUPERBOX“



Akazienholz / acacia wood / madera de acacia / bois d'acacia

	cm	↑ cm	GN	Farbe / Colour
11623	55,5 x 18,5	10,5		
11629	55,5 x 18,5	10,5		



GN 1/2 „SUPERBOX“



Akazienholz / acacia wood / madera de acacia / bois d'acacia

	cm	↑ cm	GN	Farbe / Colour
11621	35,0 x 29,0	10,5	1/2	
11627	35,0 x 29,0	10,5	1/2	
11722	35,0 x 29,0	20,0	1/2	
11724	35,0 x 29,0	20,0	1/2	



GN 1/4 „SUPERBOX“

Akazienholz / acacia wood / mader de acacia / bois d'acacia



	cm	↑ cm	Farbe / Colour
11622	29 x 18,5	10,5	
11628	29 x 18,5	10,5	



GN „SUPERBOX VINTAGE“

Akazienholz  
acacia wood  
mader de acacia  
bois d'acacia

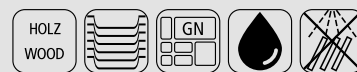

	cm	↑ cm	GN	Farbe / Colour
11715	55,5 x 35,0	10,5	1/1	
11716	35,0 x 29,0	10,5	1/2	
11717	29,0 x 18,5	10,5	1/4	
11718	55,0 x 18,5	10,5	2/4	



Präsentationsmöglichkeiten  
presentation examples



Buffetgestell

buffet stand  
soporte para buffet  
présentoir buffet



Metall, schwarz, passend für GN Boxen, mit Antrutschfüßchen  
metal, black, suitable for GN boxes, with non-slip feet  
metal, negro, para cajas GN, con pies antideslizantes  
métal, noir, pour boîtes GN, avec pieds antidérapants

	cm	↑ cm	suitable for
30331	49 x 38,5	48	GN 1/1, GN1/2 boxes



Präsentationsmöglichkeit  
presentation example



**GN Tablett „ZERO“**

GN tray  
GN bandeja  
GN plateau



	cm	↑ cm	GN	Farbe / Colour
84185	53,0 x 32,5	1,5	1/1	_____
84186	32,5 x 26,5	1,5	1/2	_____
84188	26,5 x 16,2	1,5	1/4	_____
84189	53,0 x 16,2	1,5	2/4	_____



mit Antirutschfüßchen  
with non-slip feet



**GN Naturschieferplatten**

GN natural slate tray  
GN bandeja de pizarra natural  
GN plat ardoise naturelle



	cm	GN
00990	53,0 x 32,5	1/1
00991	32,5 x 26,5	1/2
00993	26,5 x 16,2	1/4
00973	53,0 x 16,2	2/4



**GN Einsatz „SUPERBOX“**

GN insert  
GN bandeja  
GN bac supérieur



	cm	↑ cm	GN	fits to
11616	53,0 x 32,5	8,5	1/1	11620, 11626, 11715
11617	32,5 x 26,5	8,5	1/2	11621, 11627, 11716





**NEW** **4 tlg. 4 pcs.**



11546



11075

**Buche, wasserfest lackiert**  
beech wood lacquered



10791

**Kühlakku halten Ihre Speisen bis zu 6 Stunden kühl**  
cooling system keeps the food cool for up to 6 hours

**Buffetvitrine „TOP FRESH GN 1/1“**  
refrigerated buffet display  
expositor buffet frío  
plateau buffet froid



4-teilig: 1 Box aus Buchenholz mit Kunststoffwanne + 1 Edelstahl-Tablett GN 1/1 + 2 Kühlakkus, ohne Haube

4 pcs.: 1 beech wood box with plastic insert + 1 stainless steel tray GN 1/1 + 2 coolers, without cover

set de 4: 1 caja de madera de haya con bandeja de plástico + 1 bandeja de acero inoxidable GN 1/1 + 2 acumuladores de frío, sin campana

set de 4: 1 boîte en bois de hêtre avec bac en plastique + 1 plateau en acier inox GN 1/1 + 2 accumulateurs de froid, sans cloche

	cm	↑ cm
11546	60 x 41	5

**GN Rolltophaube mit schwarzem Griff / GN rolltop cover with black handle / GN campana rolltop con mango negro / GN cloche rolltop avec poignée noir**

	cm	↑ cm	GN
11075	53 x 32,5	19	1/1

**GN Rolltophaube mit Chromgriff / GN rolltop cover with chrome handle / GN campana rolltop con asa cromada / GN cloche rolltop avec poignée chromée**

	cm	↑ cm	GN
11010	53 x 32,5	19	1/1

**Kühlakku / cooler / acumulador de frío / accumulateur de froid**

	cm	↑ cm
10791	25 x 19	2,5

**NEW** **12 tlg. 12 pcs.**



11547

**Buche, wasserfest lackiert**  
beech wood lacquered



10791

**Kühlakku halten Ihre Speisen bis zu 6 Stunden kühl**  
cooling system keeps the food cool for up to 6 hours

**Buffetvitrine „DOPPELDECKER GN 1/1“**  
refrigerated buffet display  
expositor buffet frío  
plateau buffet froid



12-teilig: 2 Boxen aus Buchenholz mit Kunststoffwanne + 2 Edelstahl-Tabletts GN 1/1 + 4 Kühlakkus + 4 verchromte Stangen, ohne Hauben

12 pcs.: 2 beech wood boxes with plastic insert + 2 stainless steel trays GN 1/1 + 4 coolers + 4 chrome-plated bars, without covers

set de 12: 2 cajas de madera de haya con bandeja de plástico + 2 bandejas de acero inoxidable GN 1/1 + 4 acumuladores de frío + 4 barras cromadas, sin campanas

set de 12: 2 boîtes en bois de hêtre avec bac en plastique + 2 plateaux en acier inox GN 1/1 + 4 accumulateurs de froid + 4 barres chromées, sans cloches

	cm	↑ cm
11547	60 x 41	36

**GN Rolltophaube mit schwarzem Griff / GN rolltop cover with black handle / GN campana rolltop con asa negra / GN cloche rolltop avec poignée noir**

	cm	↑ cm	GN
11075	53 x 32,5	19	1/1

**GN Rolltophaube mit Chromgriff / GN rolltop cover with chrome handle / GN campana rolltop con asa cromada / GN cloche rolltop avec poignée chromée**

	cm	↑ cm	GN
11010	53 x 32,5	19	1/1

**Kühlakku / cooler / acumulador de frío / accumulateur de froid**

	cm	↑ cm
10791	25 x 19	2,5

## COOLING DISPLAYS

**4 tlg.**  
4 pcs.



11540



11010

**Buche, wasserfest lackiert**  
beech wood lacquered



10791

**Kühlakkus halten Ihre Speisen bis zu 6 Stunden kühl**  
cooling system keeps the food cool for up to 6 hours

### Buffetvitrine „TOP FRESH GN 1/1“

refrigerated buffet display  
expositor buffet frío  
plateau buffet froid



4-teilig: 1 Box aus Buchenholz mit Kunststoffwanne + 1 Edelstahl-Tablett GN 1/1 + 2 Kühlakkus, ohne Haube

4 pcs.: 1 beech wood box with plastic insert + 1 stainless steel tray GN 1/1 + 2 coolers, without cover

set de 4: 1 caja de madera de haya con bandeja de plástico + 1 bandeja de acero inoxidable GN 1/1 + 2 acumuladores de frío, sin campana

set de 4: 1 boîte en bois de hêtre avec bac en plastique + 1 plateau en acier inox GN 1/1 + 2 accumulateurs de froid, sans cloche

	cm	↑ cm
11540	60 x 41	5

GN Rolltophaube mit Goldgriff / GN rolltop cover with gold handle / GN campana rolltop con asa dorada / GN cloche rolltop avec poignée en or

	cm	↑ cm	GN
11008	53 x 32,5	19	1/1

GN Rolltophaube mit Chromgriff / GN rolltop cover with chrome handle / GN campana rolltop con asa cromada / GN cloche rolltop avec poignée chromée

	cm	↑ cm	GN
11010	53 x 32,5	19	1/1

Kühlakku / cooler / acumulador de frío / accumulateur de froid

	cm	↑ cm
10791	25 x 19	2,5

**12 tlg.**  
12 pcs.



11541

**Buche, wasserfest lackiert**  
beech wood lacquered



10791

**Kühlakkus halten Ihre Speisen bis zu 6 Stunden kühl**  
cooling system keeps the food cool for up to 6 hours

### Buffetvitrine „DOPPELDECKER GN 1/1“

cooling buffet display  
expositor buffet frío  
vitrine buffet



12-teilig: 2 Boxen aus Buchenholz mit Kunststoffwanne + 2 Edelstahl-Tabletts GN 1/1 + 4 Kühlakkus + 4 verchromte Stangen, ohne Hauben

12 pcs.: 2 beech wood boxes with plastic insert + 2 stainless steel trays GN 1/1 + 4 coolers + 4 chrome-plated bars, without covers

set de 12: 2 cajas de madera de haya con bandeja de plástico + 2 bandejas de acero inoxidable GN 1/1 + 4 acumuladores de frío + 4 barras cromadas, sin campanas

set de 12: 2 boîtes en bois de hêtre avec bac en plastique + 2 plateaux en acier inox GN 1/1 + 4 accumulateurs de froid + 4 barres chromées, sans cloches

	cm	↑ cm
11541	60 x 41	36

GN Rolltophaube mit Goldgriff / GN rolltop cover with gold handle / GN campana rolltop con asa dorada / GN cloche rolltop avec poignée en or

	cm	↑ cm	GN
11008	53 x 32,5	19	1/1 Gold-Griff

GN Rolltophaube mit Chromgriff / GN rolltop cover with chrome handle / GN campana rolltop con asa cromada / GN cloche rolltop avec poignée chromée

	cm	↑ cm	GN
11010	53 x 32,5	19	1/1 Chrom-Griff

Kühlakku / cooler / acumulador de frío / accumulateur de froid

	cm	↑ cm
10791	25 x 19	2,5

**3 tlg.**  
3 pcs.



11542

**Buche, wasserfest lackiert**  
beech wood lacquered



18388

11542



10791

**Kühlakkus halten Ihre Speisen bis zu 6 Stunden kühl**  
cooling system keeps the food cool for up to 6 hours

**Kühltablett „TOP FRESH RUND“**

refrigerated buffet display  
expositor buffet frío redondo  
présentoir buffet



**3-teilig: 1 Box aus Buchenholz mit Kunststoffwanne + 1 Edelstahl-Tablett Ø 38 cm + 1 Kühlakku, ohne Haube**

3 pcs.: 1 beech wood box with plastic insert + 1 stainless tray Ø 38 cm + 1 cooler, without cover

set de 3: 1 caja de madera de haya con bandeja de plástico + 1 bandeja de acero inoxidable Ø 38 cm + 1 acumulador de frío, sin campana

set de 3: 1 boîte en bois de hêtre avec bac en plastique + 1 plateau en acier inox Ø 38 cm + 1 accumulateur de froid, sans cloche

	Ø cm	↑ cm
11542	48	6

**Rolltophaube mit verchromtem Kugelgriff / rolltop cover with chrome-plated ball handle / campana abatible con asa de bola cromada / cloche basculante avec poignée boule chromée**

	Ø cm	↑ cm
18388	38	20

**Rolltophaube mit vergoldetem Kugelgriff / rolltop cover with gold-plated ball handle / campana abatible con asa de bola dorada / cloche basculante avec poignée boule plaquée or**

	Ø cm	↑ cm
18387	38	20

**Kühlakku / cooler / acumulador de frío / accumulateur de froid**

	cm	↑ cm
10791	25 x 19	2,5

**11 tlg.**  
11 pcs.



11543

**Buche, wasserfest lackiert**  
beech wood lacquered



10791

**Kühlakkus halten Ihre Speisen bis zu 6 Stunden kühl**  
cooling system keeps the food cool for up to 6 hours

**Buffetvitrine „DOPPELDECKER“**

double refrigerated buffet display  
expositor de buffet redondo doble  
présentoir buffet froid, double



**11-teilig: 2 Boxen aus Buchenholz mit Kunststoffwanne + 2 Edelstahl-Tablets Ø 38 cm + 2 Kühlakkus + 2 Kunststoffschalen + 3 verchromte Stangen, ohne Hauben**

11 pcs.: 2 beech wood boxes with plastic tray + 2 stainless steel trays Ø 38 cm, 2 coolers + 3 chrome-plated bars, without covers

set de 11: 2 cajas de madera de haya con bandeja de plástico + 2 bandejas de acero inoxidable Ø 38 cm + 2 acumuladores de frío + 2 bandejas de plástico + 3 barras cromadas, sin campanas

set de 11: 2 boîtes en bois de hêtre avec bac en plastique + 2 plateaux en inox Ø 38 cm + 2 accumulateurs de froid + 2 plateaux en plastique + 3 barres chromées, sans cloches

	Ø cm	↑ cm
11543	48	38

**Rolltophaube mit verchromtem Kugelgriff / rolltop cover with chrome-plated ball handle / campana abatible con asa de bola cromada / cloche basculante avec poignée boule chromée**

	Ø cm	↑ cm
18388	38	20

**Rolltophaube mit vergoldetem Kugelgriff / rolltop cover with gold-plated ball handle / campana abatible con asa de bola dorada / cloche basculante avec poignée boule plaquée or**

	Ø cm	↑ cm
18387	38	20

**Kühlakku / cooler / acumulador de frío / accumulateur de froid**

	cm	↑ cm
10791	25 x 19	2,5

## COOLING DISPLAYS



### Kühlbox „SLATE“ refrigerated buffet display expositor buffet frío plateau buffet froid

3-teilig, bestehend aus: 1 Basis aus schwarzem Polystyrol,  
1 Naturschieferplatte, 1 Kühlakku (ohne Haube)

3 pcs., set consists of: 1 base made of black polystyrene, 1 natural slate tray, 1 cooler (without cover)

set de 3 compuesto por: 1 soporte de poliestireno negro, 1 bandeja de pizarra natural, 1 acumulador de frío (sin campana)

set de 3 composé de: 1 support en polystyrène noir, 1 plateau en ardoise naturelle, 1 accumulateur de froid (sans couvercle)



	cm	↑ cm
11645	58 x 38	6,5

Naturschieferplatte / natural slate tray / bandeja de pizarra natural / plateau ardoise naturelle

	cm	* mm
00979	58 x 38	6 - 9

Kühlakku / cooler / acumulador de frío / accumulateur de froid

	cm	↑ cm
10782	41 x 21	2,5

GN Rolltophaube mit schwarzem Griff / GN rolltop cover with black handle / GN campana rolltop con mango negro / GN cloche rolltop avec poignée noire

	cm	↑ cm	GN
11075	53 x 32,5	19	1/1



### Buffetvitrine „TOP FRESH GN 1/1“ cooling buffet display expositor buffet frío présentoir buffet

5-teilig: 1 Edelstahl-Tablett GN 1/1 + 2 Kühlakkus + 1 Edelstahl-Schale + 1 Acrylrahmen, ohne Haube

5 pcs.: 1 stainless steel tray GN 1/1 + 2 coolers + 1 stainless steel tray + 1 acrylic frame, without cover

set de 5: 1 bandeja de acero inoxidable GN 1/1 + 2 acumuladores de frío + 1 bandeja de acero inoxidable, 1 marco acrílico, sin campana

set de 5: 1 plateau en acier inox GN 1/1 + 2 accumulateurs de froid + 1 plateau inox - 1 cadre acrylique, sans cloche



	cm	↑ cm
11510	61 x 38	8

### Buffetvitrine „DOPPELDECKER GN1/1“ cooling buffet display expositor buffet frío présentoir buffet

14-teilig: 2 Edelstahl-Tablets GN 1/1 + 4 Kühlakkus + 2 Edelstahl-Schale + 2 Acrylrahmen + 4 verchromte Stangen, ohne Hauben

14 pcs.: 2 stainless steel trays GN 1/1 + 4 coolers + 2 stainless steel trays, 2 acrylic frame + 4 chrome-plated bars, without covers

set de 14: 2 bandejas de acero inoxidable GN 1/1 + 4 acumuladores de frío + 2 bandejas de acero inoxidable + 2 marcos acrílicos, 4 barras cromadas, sin campana

set de 14: 2 plateaux en acier inox GN 1/1 + 4 accumulateurs de froid, 2 bacs en acier inox + 2 cadres en acrylique + 4 barres chromées, sans cloches



	cm	↑ cm
11514	61 x 38	33

GN Rolltophaube / GN rolltop cover / GN campana rolltop / GN cloche rolltop

	cm	↑ cm	GN
11010	53 x 32,5	19	1/1

Kühlakku / cooler / acumulador de frío / accumulateur de froid

	cm	↑ cm
10791	25 x 19	2,5

**4 tlg.**  
4 pcs.

18388

11512

18388

11101

**Kühlakkus halten Ihre Speisen bis zu 6 Stunden kühl**  
cooling system keeps the food cool for up to 6 hours

**Kühlatablett „TOP FRESH RUND“**

cooling plate  
expositor buffet frío  
présentoir buffet



**4-teilig:** 1 Edelstahl-Tablett Ø 38 cm + 2 Kühlakkus + 1 Edelstahl-Schale + 1 Acrylrahmen, ohne Haube

4 pcs.: 1 stainless steel tray Ø 38 cm + 2 coolers + 1 stainless steel tray + 1 acrylic frame, without cover

set de 4: 1 bandeja de acero inox Ø 38 cm + 2 acumuladores de frío + 1 bandeja de acero inox + 1 marco acrílico, sin campana

set de 4: 1 plateau en acier inox Ø 38 cm + 2 accumulateurs de froid + 1 cadre acrylique, sans cloche

	Ø cm	↑ cm
11512	43,5	5,5

**Rolltophaube mit verchromtem Kugelgriff** / rolltop cover with chrome-plated ball handle / campana abatible con asa de bola cromada / cloche basculante avec poignée boule chromée

	Ø cm	↑ cm	
18388	38	20	mit verchromtem Kugelgriff

**Kühlakku** / cooler / acumulador de frío / accumulateur de froid

	cm	↑ cm	pcs.
11101	16 x 7,5	2	4

**4 tlg.**  
4 pcs.

11010

11503

11100

11505

11010

11505

10791

**Kühlakkus halten Ihre Speisen bis zu 6 Stunden kühl**  
cooling system keeps the food cool for up to 6 hours

**Kühlbox „TOP FRESH GN 1/1“**

cooling plate  
bandeja de frío  
présentoir buffet réfrigéré



**4-teilig:** 1 Kühlbox + 1 Tablett GN 1/1 + 2 Kühlakkus, ohne Haube

4 pcs.: 1 box + 1 tray GN 1/1 + 2 coolers, without cover

set de 4: 1 caja + 1 bandeja GN 1/1 + 2 acumuladores de frío, sin campana

set de 4: 1 caisson + 1 plateau GN 1/1 + 2 accumulateurs de froid, sans cloche

	cm	↑ cm	Farbe / Colour
11503	56,5 x 35	6,5	White
11505	56,5 x 35	6,5	Black

**GN Rolltophaube mit vergoldetem Kreuzgriff** / GN rolltop cover with gold-plated cross handle / GN campana rolltop con asa en cruz dorada / GN cloche rolltop avec manche en croix plaqué or

	cm	↑ cm	GN	
11008	53,0 x 32,5	19	1/1	mit vergoldetem Kreuzgriff

**GN Rolltophaube mit verchromtem Kreuzgriff** / GN rolltop cover with chrome-plated cross handle / GN campana rolltop con asa en cruz cromada / GN cloche rolltop avec manche en croix chromée

	cm	↑ cm	GN	
11010	53 x 32,5	19	1/1	mit verchromtem Kreuzgriff

**Kühlakku** / cooler / acumulador de frío / accumulateur de froid

	cm	↑ cm
10791	25 x 19	2,5

**GN Edelstahl-Tablett „PROFI LINE“** / GN tray / GN bandeja / GN plateau

	cm	↑ cm	GN
11100	53 x 32,5	1,5	1/1

## COOLING DISPLAYS

18388

11538

10791

**Kühlakkus halten Ihre Speisen bis zu 6 Stunden kühl**  
cooling system keeps the food cool for up to 6 hours

### Kühlbox „TOP FRESH SET“

cooling plate  
bandeja de frío  
set frigorifère



**3-teilig: 1 Box + 1 Tablett Ø 38 cm + 1 Kühlakku, ohne Haube**

3 pcs.: 1 box + 1 tray Ø 38 cm + 1 cooler, without cover

set de 3: 1 caja + 1 bandeja Ø 38 cm + 1 acumulador de frío, sin campana

set de 3: 1 caisson + 1 plateau Ø 38 cm + 1 accumulateur de froid, sans cloche

	Ø cm	↑ cm	Farbe / Colour
11538	42	6	White
11533	42	6	Black

**Rolltophaube mit verchromtem Kugelgriff / rolltop cover with chrome-plated ball handle / campana abatible con asa de bola cromada / cloche basculante avec poignée boule chromée**

	Ø cm	↑ cm
18388	38	20

**Kühlakku / cooler / acumulador de frío / accumulateur de froid**

	cm	↑ cm
10791	25 x 19	2,5

18388

09082

11101

**Kühlakkus halten Ihre Speisen bis zu 6 Stunden kühl**  
cooling system keeps the food cool for up to 6 hours

### Thermo-Set

thermo set  
bandeja isotérmica  
set thermo



**5-teilig: 1 Tablett tief + 1 Tablett flach + 2 Kühlakkus + 1 Rolltophaube**

5 pcs.: 1 deep tray + 1 tray + 2 cooler + 1 rolltop cover

set de 5: 1 1 bandeja honda + 1 bandeja plana + 2 acumuladores frío + 1 campana rolltop

set de 5: 1 plateau creux + 1 plateau plat + 2 accumulateurs de froid + 1 cloche rolltop

	Ø cm	↑ cm
09082	38	24

**Rolltophaube mit verchromtem Kugelgriff / rolltop cover with chrome-plated ball handle / campana abatible con asa de bola cromada / cloche basculante avec poignée boule chromée**

	Ø cm	↑ cm
18388	38	20

**Kühlakku / cooler / acumulador de frío / accumulateur de froid**

	cm	↑ cm	pcs.
11101	16 x 7,5	2	4

4 tlg.  
4 pcs.

09083

11101

**Kühlakkus halten Ihre Speisen bis zu 6 Stunden kühl**  
cooling system keeps the food cool for up to 6 hours

### Thermo-Set

thermo set  
porta tartas refrigerado  
porte-gâteau réfrigéré



**4-teilig: 1 Tablett tief auf Fuß + 1 Tablett flach + 2 Kühlakkus**

4 pcs.: 1 deep tray with feet + 1 tray + 2 coolers

set de 4: 1 bandeja honda con pie + 1 1 bandeja plana + 2 acumuladores de frío

set de 4: 1 plateau creux avec pied + 1 plateau plat + 2 accumulateurs de froid

	Ø cm	↑ cm
09083	38	14,5

**Rolltophaube mit verchromtem Kugelgriff / rolltop cover with chrome-plated ball handle / campana abatible con asa de bola cromada / cloche basculante avec poignée boule chromée**

	Ø cm	↑ cm
18388	38	20

**Kühlakku / cooler / acumulador de frío / accumulateur de froid**

	cm	↑ cm	pcs.
11101	16 x 7,5	2	4



4 tlg.  
4 pcs.

9 cm

11812 0,6 ltr.



11,5 cm

11813 1 ltr.



10661

**Kühlakkus halten Ihre Speisen bis zu 6 Stunden kühl**  
cooling system keeps the food cool for up to 6 hours

**Kühlschale Mini Holz „TOP FRESH“**

cool bowl mini holz  
bol refrigerado mini madera  
bol réfrigéré mini bois



4-teilig: 1 Fuß Buchenholz versiegelt + 1 Schale + 1 Kühlakku + 1 klappbarer Deckel mit Beschriftungsschild

4 pcs.: 1 foot beech wood + 1 bowl + 1 cooler + 1 hinged cover with label

set de 4: 1 base de madera de haya + 1 cuenco + 1 acumulador de frío + 1 tapa abatible con etiqueta

set de 4: 1 pied en hêtre + 1 bac + 1 accumulateur de froid + 1 couvercle à charnière avec étiquette

	Ø cm	↑ cm	ltr.
11812	14	9,0	0,6
11813	14	11,5	1,0

**Ersatzschale / spare bowl / cuenco de recambio / bol de rechange**

	Ø cm	↑ cm
11811	14	6,5
11816	14	9,0

**Schutzdeckel mit Löffelaussparung / cover / tapa / couvercle**

	Ø cm
11868	14,5

**Kühlakku / cooler / acumulador de frío / accumulateur de froid**

	Ø cm	↑ cm
10661	10,5	2



4 tlg.  
4 pcs.

14 cm

11817  
2,5 ltr.



18 cm

11818  
4 ltr.

**Kühlschale Maxi Holz „TOP FRESH“**

cool bowl maxi holz  
bol refrigerado maxi madera  
bol réfrigéré maxi bois



4-teilig: 1 Fuß Buchenholz versiegelt + 1 Schale + 1 Kühlakku + 1 klappbarer Deckel mit Beschriftungsschild

4 pcs.: 1 foot beech wood + 1 bowl + 1 cooler + 1 hinged cover with label

set de 4: 1 base de madera de haya + 1 cuenco + 1 acumulador de frío + 1 tapa abatible con etiqueta

set de 4: 1 pied en hêtre + 1 bac + 1 accumulateur de froid + 1 couvercle à charnière avec étiquette

	Ø cm	↑ cm	ltr.
11817	22	14	2,5
11818	22	18	4,0

**Ersatzschale / spare bowl / cuenco de recambio / bol de rechange**

	Ø cm	↑ cm
11846	22	8
11848	22	12

**Schutzdeckel mit Löffelaussparung / cover / tapa / couvercle**

	Ø cm
11878	23,5

**Kühlakku / cooler / acumulador de frío / accumulateur de froid**

	Ø cm	↑ cm
10777	15	2,5

## COOLING DISPLAYS

**4 tlg.**  
4 pcs.



9 cm

11812 0,6 ltr.



11,5 cm

11815 1 ltr.



10661

**Kühlakkus halten Ihre Speisen bis zu 6 Stunden kühl**  
cooling system keeps the food cool for up to 6 hours

### Kühlschale Mini „TOP FRESH“

cool bowl mini  
bol refrigerado mini  
bol réfrigéré mini



4-teilig: 1 Edelstahlgefäß matt + 1 Kühlakku + 1 Schale + 1 klappbarer Deckel mit Beschriftungsschild

4 pcs.: 1 stainless steel bowl matt + 1 bowl + 1 cooler + 1 hinged cover with label

set de 4: 1 recipiente de acero inoxidable mate + 1 cuenco + 1 acumulador de frío + 1 tapa abatible con etiqueta

set de 4: 1 récipient en acier inox mat + 1 bac + 1 accumulateur de froid + 1 couvercle à charnière avec étiquette

	Ø cm	↑ cm	ltr.
11810	14	9,0	0,6
11815	14	11,5	1,0

Ersatzschale / spare bowl / cuenco de recambio / bol de rechange

	Ø cm	↑ cm
11811	14	6,5
11816	14	9,0

Schutzdeckel mit Löffelaussparung / cover / tapa / couvercle

	Ø cm
11868	14,5

Kühlakku / cooler / acumulador de frío / accumulateur de froid

	Ø cm	↑ cm
10661	10,5	2

**4 tlg.**  
4 pcs.



14 cm

11847 2,5 ltr.



18 cm

11849 4 ltr.

### Kühlschale Maxi „TOP FRESH“

cool bowl maxi  
bol refrigerado maxi  
bol réfrigéré maxi



4-teilig: 1 Edelstahlgefäß hochglanzpoliert + 1 Kühlakku + 1 Schale + 1 klappbarer Deckel mit Beschriftungsschild

4 pcs.: 1 stainless steel bowl matt + 1 bowl + 1 cooler + 1 hinged cover with label

set de 4: 1 recipiente de acero inoxidable mate + 1 cuenco + 1 acumulador de frío + 1 tapa abatible con etiqueta

set de 4: 1 récipient en acier inox mat + 1 bac + 1 accumulateur de froid + 1 couvercle à charnière avec étiquette

	Ø cm	↑ cm	ltr.
11847	22	14	2,5
11849	22	18	4,0

Ersatzschale / spare bowl / cuenco de recambio / bol de rechange

	Ø cm	↑ cm
11846	22	8
11848	22	12

Schutzdeckel mit Löffelaussparung / cover / tapa / couvercle

	Ø cm
11878	23,5

Kühlakku / cooler / acumulador de frío / accumulateur de froid

	Ø cm	↑ cm
10777	15	2,5



4 tlg.  
4 pcs.



11845  
2,5 ltr.



11875

**Kühlschale Maxi „TOP FRESH“**

cool bowl maxi  
cuenco refrigerado maxi  
bol réfrigéré maxi



4-teilig: 1 Gefäß hochglanzpoliert + 1 Kühlakku + 1 Glasschale + 1 klappbarer Deckel mit Beschriftungsschild

4 pcs.: 1 stainless steel bowl mirror polished + 1 cooler + 1 glass bowl + 1 hinged cover with label

set de 4: 1 recipiente de acero inoxidable pulido brillante + 1 acumulador de frío + 1 cuenco de vidrio + 1 tapa abatible con etiqueta

set de 4: 1 récipient en acier inox poli mat + 1 accumulateur de froid + 1 bol en verre + 1 couvercle à charnière avec étiquette

	Ø cm	↑ cm	ltr.
11845	23	14	2,5

**Ersatzschale / spare bowl / cuenco de recambio / bol de rechange**

	Ø cm	↑ cm	ltr.
11875	23	10,5	2,5

**Schutzdeckel mit Löffelaussparung / cover / tapa / couvercle**

	Ø cm
11878	23,5

**Kühlakku / cooler / acumulador de frío / accumulateur de froid**

	Ø cm	↑ cm
10777	15	2,5

**Schale „CASUAL MAXI“**

bowl  
cuenco  
bol



83696



83705



83920

	Ø cm	↑ cm	ltr.	Farbe / Colour
83696	10	4,5	0,15	White
83698	12	5,5	0,25	White
83700	14	6,5	0,50	White
83704	20	9,2	1,80	White
83702	23	10,5	2,50	White

	Ø cm	↑ cm	ltr.	Farbe / Colour
83697	10	4,5	0,15	Black
83699	12	5,5	0,25	Black
83701	14	6,5	0,50	Black
83705	20	9,2	1,80	Black
83703	23	10,5	2,50	Black

**Deckel „FLOAT“ mit Löffelaussparung / cover, with notched for spoons / tapa, con espacio para la cuchara / couvercle, avec encoche pour la louche**

	Ø cm	↑ cm	fits to
83920	20,5	1,3	83704, 83705

## COOLING DISPLAYS

09100

09102

90902

11101

**Kühlakkus halten Ihre Speisen bis zu 6 Stunden kühl**  
cooling system keeps the food cool for up to 6 hours

### Buffetvitrine showcase vitrina de buffet vitrine de buffet



5-teilig: 1 transparente Rolltophaube beidseitig aufklappbar + 1 Schale (ABS) + 1 Edelstahl-Tablett 39 x 28 cm + 2 Kühlakkus

5 pcs.: 1 transparent rolltop cover + 1 tray (ABS) + 1 stainless tray 39 x 28 cm + 2 coolers  
set de 5: 1 tapa abatible, por ambos lados, transparente + 1 bandeja (ABS) + 1 bandeja de acero inoxidable 39 x 28 cm + 2 acumuladores de frío

set de 5: 1 cloche transparente ouverture 2 côtés + 1 caisson (ABS) + 1 plateau en acier inox 39 x 28 cm + 2 accumulateurs de froid

	cm	↑ cm	Farbe / Colour
09100	44 x 32	20,5	White
09102	44 x 32	20,5	Blue
09104	44 x 32	20,5	Black

#### Kühlakku / cooler / acumulador de frío / accumulateur de froid

	cm	↑ cm	pcs.
11101	16 x 7,5	2	4

#### Edelstahl-Tablett / stainless steel tray / bandeja de acero inoxidable / plateau inox

	cm	↑ cm
90902	39,5 x 28,5	1



Servierbeispiel  
presentation example

09200

09202

09204

### Buffetvitrine „DOPPELDECKER“ showcase vitrina de buffet, 2 alturas vitrine de buffet double



2 transparente Rolltophauben beidseitig aufklappbar + 2 Schalen (ABS) + 2 Edelstahl-Tabletts 39 x 28 cm + 4 Kühlakkus, platzsparend lagerbar

2 transparent rolltop cover + 2 trays (ABS) + 2 tray 39 x 28 cm + 4 coolers, space saving  
2 campanas abatibles por ambos lados transparentes + 2 bandejas (ABS) + 2 bandejas de acero inoxidable 39 x 28 cm + 4 acumuladores de frío, almacenamiento en poco espacio

2 cloches transparentes abattantes 2 côtés + 2 caissons (ABS) + 2 plateaux en acier inox 39 x 28 cm + 4 accumulateurs de froid, peut encombrant à stocker

	cm	↑ cm	Farbe / Colour
09200	44 x 32	44	White
09202	44 x 32	44	Blue
09204	44 x 32	44	Black

#### Kühlakku / cooler / acumulador de frío / accumulateur de froid

	cm	↑ cm	pcs.
11101	16 x 7,5	2	4

#### Edelstahl-Tablett / stainless steel tray / bandeja de acero inoxidable / plateau inox

	cm	↑ cm
90902	39,5 x 28,5	1



6 tlg.  
6 pcs.



09091

09090

**Thermo Tablett-Set, 6-teilig**

thermo tray, 6 pcs.

bandeja térmica, set de 6

plateau thermique, set de 6



6-teilig:

- 1 Schale
- 1 Edelstahltablett
- 2 Kühlakkus
- 1 transparente Frischhaltehaube
- 1 Transport- und Tragegurt aus Silikon

6 pcs.:

- 1 plastic tray
- 1 stainless steel tray
- 2 coolers
- 1 transparent cover
- 1 silicone transport and carrying strap

set de 6:

- 1 bandeja de plástico
- 1 bandeja de acero inoxidable
- 2 acumuladores de frío
- 1 campana transparente
- 1 correa de silicona para cierre y transporte

set de 6:

- 1 plateau plastique
- 1 plateau en acier inox
- 2 accumulateurs de froid
- 1 cloche transparente
- 1 sangle en silicone pour fermeture et transport

inklusive  
Transport- und  
Tragegurt!

	cm	↑ cm	Farbe / Colour
09091	43 x 29	14	■
09090	43 x 29	14	■



inklusive 2 Kühlakkus  
including 2 coolers



6 tlg.  
6 pcs.



09094

09093

**Thermo Tablett-Set, 6-teilig**

thermo tray, 6 pcs.

bandeja térmica, set de 6

plateau thermique, set de 6



6-teilig:

- 1 Schale
- 1 Edelstahltablett
- 2 Kühlakkus
- 1 transparente Frischhaltehaube
- 1 Transport- und Tragegurt aus Silikon

6 pcs.:

- 1 plastic tray
- 1 stainless steel tray
- 2 coolers
- 1 transparent cover
- 1 silicone transport and carrying strap

set de 6:

- 1 bandeja de plástico
- 1 bandeja de acero inoxidable
- 2 acumuladores de frío
- 1 campana transparente
- 1 correa de silicona para cierre y transporte

set de 6:

- 1 plateau plastique
- 1 plateau en acier inox
- 2 accumulateurs de froid
- 1 cloche transparente
- 1 sangle en silicone pour fermeture et transport

inklusive  
Transport- und  
Tragegurt!

	cm	↑ cm	Farbe / Colour
09094	35	15	■
09093	35	15	■



inklusive 2 Kühlakkus  
including 2 coolers



# BEVERAGE DISPENSERS



## Getränkespender „INDUSTRIAL“

beverage dispenser  
dispensador de bebidas  
distributeur de boissons

Black  
is  
beautiful

GLAS  
GLASS

EDELSTAHL  
STAINLESS  
INOX

METALL

SILIKON  
SILICON

NON  
SLIP FEET

Behälter aus Glas, Zapfhahn aus Edelstahl, Fuß und Deckel aus Metall, schwarz, Antirutschmatte aus Silikon

glass container, stainless steel tap, base and lid in black metal, silicone non-slip mat  
recipiente de vidrio, grifo de acero inoxidable, base y tapa de metal negro, tapete antideslizante de silicona

réceptien en verre, robinet en acier inox, pied et couvercle en métal noir, tapis antidérapant en silicone

	Ø cm	↑ cm	ltr.	
10450	20	45	7	inkl. Gestell / incl. stand



Antirutschmatte aus Silikon  
Antirutschmatte aus Silikon



## Getränkespender „URBAN“

beverage dispenser  
dispensador de bebidas  
distributeur de boissons

Black  
is  
beautiful

GLAS  
GLASS

EDELSTAHL  
STAINLESS  
INOX

METALL

SILIKON  
SILICON

Behälter aus Glas, Zapfhahn aus Edelstahl, Fuß und Deckel aus Metall, schwarz, Antirutschmatte aus Silikon

glass container, stainless steel tap, base and lid in black metal, silicone non-slip mat  
recipiente de vidrio, grifo de acero inoxidable, base y tapa de metal negro, tapete antideslizante de silicona

réceptien en verre, robinet en acier inox, pied et couvercle en métal noir, tapis antidérapant en silicone

	Ø cm	↑ cm	ltr.	
10451	22	45	7	inkl. Gestell / incl. stand



Antirutschmatte aus Silikon  
Antirutschmatte aus Silikon



## Eiswasserröhre

ice cube cooling tube  
tubo enfriador para cubitos  
tube pour glaçons

PP  
POLYPROPYLEN



	Ø cm	↑ cm	passend für Getränkenspender / fits to drink dispenser
10849	11	24	10400, 10403, 10450, 10451, 10855



7 ltr.

**Getränkespender „ELEMENT“**

beverage dispenser  
dispensador de bebidas  
distributeur de boissons



**Behälter aus Glas, Zapfhahn aus Edelstahl, Fuß und Deckel aus Beton**

glass container, stainless steel tap, stand and lid made of concrete  
recipiente de vidrio, grifo de acero inoxidable, soporte y tapa de hormigón  
récipient en verre, robinet en acier inox, support et couvercle en béton

	Ø cm	↑ cm	ltr.	
10400	22	45	7	inkl. Gestell / incl. stand



7 ltr.

**Getränkespender „ASIA“**

beverage dispenser  
dispensador de bebidas  
distributeur de boissons



**Behälter aus Glas, Zapfhahn aus Edelstahl, Fuß und Deckel aus Holz**

glass container, stainless steel tap, wooden stand and lid  
recipiente de vidrio, grifo de acero inoxidable, soporte y tapa de madera  
récipient en verre, robinet en acier inox, support et couvercle en bois

	Ø cm	↑ cm	ltr.	
10403	24,5	45,5	7	inkl. Gestell / incl. stand

Ersatz-Fuß / base / soporte de recambio / support de remplacement

	Ø cm	↑ cm	
10404	24,5	15	

Ersatz-Deckel / replacement lid / tapa de recambio / couvercle de rechange

	Ø cm	↑ cm	
10405	14,0	5	



7 ltr.

**Getränkespender „OLD FASHIONED“**

beverage dispenser  
dispensador de bebidas  
distributeur de boissons



**Behälter aus Glas, Zapfhahn aus Edelstahl, Gestell schwarz**

glass container, stainless steel tap, black stand  
recipiente de vidrio, grifo de acero inoxidable, soporte negro  
récipient en verre, robinet en acier inox, support noir

	Ø cm	↑ cm	ltr.	
10409	27	50,5	7	inkl. Gestell / incl. stand

Ersatz-Gestell / stand / soporte de recambio / support de remplacement

	Ø cm	↑ cm	
10410	27	31,5	

Ersatz-Glas / replacement glass / cristal de recambio / vitre de rechange

	Ø cm	↑ cm	ltr.	
10411	19	36,5	7	

Ersatz-Zapfhahn 10409 / replacement tap for 10409

	Ø cm	↑ cm	
10718			



10853

**Tropfenschale, 2-teilig**

drip tray, 2 pcs.  
aros anti-goteo, set de 2  
anneaux coupe-gouttes, set de 2



	Ø cm	↑ cm	Farbe / Colour
10851	9,5	1,5	White
10853	9,5	1,5	Black

## BEVERAGE DISPENSERS



### Getränkespender

beverage dispenser  
dispensador de bebidas  
distributeur de boissons



**Behälter aus Glas, Zapfhahn aus Edelstahl, Deckel aus Edelstahl**

glass container, stainless steel tap, lid in stainless steel  
recipiente de vidrio, grifo de acero inoxidable, tapa de acero inoxidable  
récipient en verre, robinet en acier inox, couvercle en acier inox

	Ø cm	↑ cm	ltr.
10855	20	30,5	7



### Getränkespender „FRUITS“

beverage dispenser  
dispensador de bebidas  
distributeur de boissons



**Behälter aus Glas, Zapfhahn aus Edelstahl, Gestell schwarz**

glass container, stainless steel tap, black stand  
recipiente de vidrio, grifo de acero inoxidable, soporte negro  
récipient en verre, robinet en acier inox, support noir

	Ø cm	↑ cm	ltr.	
10415	25	58	10,5	inkl. Gestell / incl. stand

### Trinkglas „BEACH“

drinking glass / vaso / verre



	Ø cm	↑ cm	ltr.	VE
10505	8,5	13,5	0,3	48

### Ersatzteile Getränkspender „FRUITS“

spare parts beverage dispenser  
recambios dispensador de bebidas  
pièces distributeur de boissons



**Ersatz-Deckel / replacement glass / cristal de recambio / vitre de rechange**

	Ø cm	↑ cm
10418	14	12

**Ersatz-Glas inklusive Deckel, ohne Zapfhahn / replacement glass with lid without tap / cristal de recambio con tapa sin grifo / vitre de rechange avec couvercle sans robinet**

	Ø cm	↑ cm	ltr.
10417	25	42	10,5

**Ersatz-Zapfhahn / replacement tap / grifo de recambio / robinet de rechange**



10718			
-------	--	--	--

**Ersatz-Gestell / stand / soporte de recambio / support de remplacement**



	Ø cm	↑ cm
10416	26	19



4,5 ltr.

300 ml



4,5 ltr.

**Getränkespender „FRESH WOOD“**

beverage dispenser  
dispensador de bebidas  
distributeur de boissons



**Behälter mit Edelstahlzapfhahn und Korkdeckel, stabiles Glas, inklusive Holzstandfuß und Kork-Untersetzer**

container with stainless steel tap and cork cover, solid glas, including wooden base and cork coaster

recipiente con grifo de acero inoxidable y tapa de corcho, cristal sólido, pie de madera y posavasos de corcho

réipient avec robinet en acier inox et covercle de liège, verre robuste, pied en bois et soucoupes de liège

	cm	↑ cm	ltr.
10430	23 x 23	56,5	4,5

**Trinkbecher „CRYSTAL“**  
drinking cup / vaso / gobelet



	Ø cm	↑ cm	ltr.	VE
10501	8	12,5	0,3	48

**Tropfenschale / drip tray / aro anti-goteo / anneau coupe-gouttes**



	Ø cm	↑ cm	Farbe / Colour
10851	9,5	1,5	White

**Ersatzteile Getränkspender „FRESH WOOD“**

spare parts beverage dispenser  
recambios dispensador de bebidas  
pièces distributeur de boissons

**Ersatz-Deckel / replacement lid / tapa de recambio / couvercle de rechange**

	Ø cm	↑ cm	Farbe / Colour
10428	11,5	1,5	Orange

**Ersatz-Glas inklusive Zapfhahn / replacement glass with tap / cristal de recambio con grifo / vitre de rechange avec robinet**

	Ø cm	↑ cm	ltr.
10422	15,5	42,0	4,5

**Ersatz-Untersetzer aus Kork / replacement cork coaster / posavasos de corcho de recambio / soucoupes de liège de rechange**

	Ø cm	↑ cm
10424	16,5	1,5

**Ersatz-Gestell / stand for / soporte de recambio / support de remplacement**

	cm	↑ cm	Farbe / Colour
10426	23 x 23	14	Orange

# BEVERAGE DISPENSERS



## Getränkespender „NORDIC WOOD“

beverage dispenser  
dispensador de bebidas  
distributeur de boissons



**Behälter mit Edelstahlzapfhahn und Holzdeckel, stabiles Glas, inklusive weißem Holzstandfuß und Kork-Untersetzer**

container with stainless steel tap and wooden cover, solid glass, including white wooden base and cork coaster

recipiente con grifo de acero inoxidable y tapa de madera, cristal sólido, pie de madera blanca y posavasos de corcho

réipient avec robinet en acier inox et couvercle en bois, verre robuste, pied en bois blanc et soucoupes de liège

	cm	↑ cm	ltr.
10435	23 x 23	60,5	7,5

## Trinkbecher „CRYSTAL“

drinking cup / vaso / gobelet



	Ø cm	↑ cm	ltr.	VE
10501	8	12,5	0,3	48

## Ersatzteile Getränkspender „NORDIC WOOD“

parts beverage dispenser  
recambios dispensador de bebidas  
pièces distributeur de boissons

**Ersatz-Deckel / replacement lid / tapa de recambio / couvercle de rechange**

	Ø cm	↑ cm
10428	11,5	1,5

**Ersatz-Glas inklusive Zapfhahn / replacement glass with tap / cristal de recambio con grifo / vitre de rechange avec robinet**

	Ø cm	↑ cm	ltr.
10427	17	46	7,5

**Ersatz-Untersetzer aus Kork / replacement cork coaster / posavasos de corcho de recambio / soucoupes de liège de rechange**

	Ø cm	↑ cm
10424	16,5	1,5

**Ersatz-Gestell / stand for / soporte de recambio / support de remplacement**

	cm	↑ cm	Farbe / Colour
10426	23 x 23	14	





**Saftdispenser „TOP FRESH“**

juice dispenser  
dispensador de zumo  
distributeur à jus de fruit



hochglanzpoliert, Kühlung durch 2 Kühlakkus von oben und unten  
mirror polished, cooling with 2 cooling elements from the top and base

pulido brillante, con 2 acumuladores de frío, 1 arriba y 1 en la base  
poli brillante, 2 accumulateurs de froid, 1 dans le couvercle, 1 dans le socle

	cm	↑ cm	ltr.
10800	21 x 32	43	4
10700	23 x 35	52	6



**Saftdispenser DUO „TOP FRESH“**

juice dispenser  
dispensador de zumo  
distributeur à jus de fruit



hochglanzpoliert, Kühlung durch 2 Kühlakkus von oben und unten

mirror polished, cooling with 2 cooling elements from the top and base

pulido brillante, con 2 acumuladores de frío, 1 arriba y 1 en la base  
poli brillante, 2 accumulateurs de froid, 1 dans le couvercle, 1 dans le socle

	cm	↑ cm	ltr.
10720	42 x 32	52	2 x 6



**Saftdispenser „INOX STAR“**

juice dispenser  
dispensador de zumo  
distributeur à jus de fruit



**Edelstahl-Crushed Ice Röhre herausnehmbar**

removable stainless steel crash ice tube  
con tubo inox refrigerante extraíble para hielo picado  
avec tube inox réfrigérant amovible pour glace pilée

	cm	↑ cm	ltr.
10795	36 x 26	55	8

**Behälter / container / recipiente / récipient**

	Ø cm	ltr.
10796	22	8



**Iso-Dispenser**

insulated dispenser  
dispensador isotérmico  
distributeur de boisson isothermique



**für heiße und kalte Getränke**

for hot and cold drinks  
para bebidas frías y calientes  
pour boissons chaudes ou froides

	Ø cm	↑ cm	ltr.
10788	24	42	9,5

**Hahn / tap / grifo / robinet**

10789			
-------	--	--	--

**einklappbare Füße**  
foldable feet

9,5 ltr.

# BEVERAGE DISPENSERS



## 1) Deckel / cover / tapa / couvercle

für ltr. / for ltr. / para ltr. / pour ltr.

10701	6
10801	4

## 2) Kühlakku / cooler / acumulador de frío / accumulateur de froid

für ltr. / for ltr. / para ltr. / pour ltr.

10777	4 / 6
-------	-------

## 3) Behälter inklusive Zapfhahn / container incl. tap recipiente con grifo / récipient avec robinet

für ltr. / for ltr. / para ltr. / pour ltr.

10703	6
10803	4

## 3) Behälter ohne Zapfhahn / container without tap recipiente sin grifo / récipient sans robinet

für ltr. / for ltr. / para ltr. / pour ltr.

10704	6
10804	4

## 4) Non-Drip Hahn / non-drip tap / grifo anti-goteo / robinet anti-goutte

für ltr. / for ltr. / para ltr. / pour ltr.

10707	6
10807	4

## 5) Dichtungsring / sealing ring / arandela / rondelle

für ltr. / for ltr. / para ltr. / pour ltr.

10608	4 / 6
-------	-------

## 6) Einsatz / insert / aro inox / cercle inox

für ltr. / for ltr. / para ltr. / pour ltr.

10708	6
10808	4

## 7) Standfuß 18/10 Edelstahl / column 18/10 stainless steel base inox 18/10 / socle inox 18/10

für ltr. / for ltr. / para ltr. / pour ltr.

10709	6
10809	4

## 8) Tropfgitter 18/10 Edelstahl / drip lattice 18/10 stainless steel rejilla recoge gotas 18/10 / grille ramasse-gouttes 18/10

für ltr. / for ltr. / para ltr. / pour ltr.

10712	6
10713	DUO
10812	4

## 9) Bodenplatte 18/10 Edelstahl / footing 18/10 stainless steel base de 18/10 acero / socle inox 18/10

für ltr. / for ltr. / para ltr. / pour ltr.

10710	6
10711	DUO / 6 + 6
10814	4

## 1x Dichtung, 2x Dichtungsring (transparent), 1x Dichtung (s / w) 1x seal, 2x sealing ring (transparent), 1x sealing ring (b / w)

## Zubehör / Reinigungsset - für die regelmäßige Reinigung

10714	für Zapfhahn 10707
10715	für Zapfhahn 10807
10716	für Zapfhahn 10907
10717	für Zapfhahn 10867



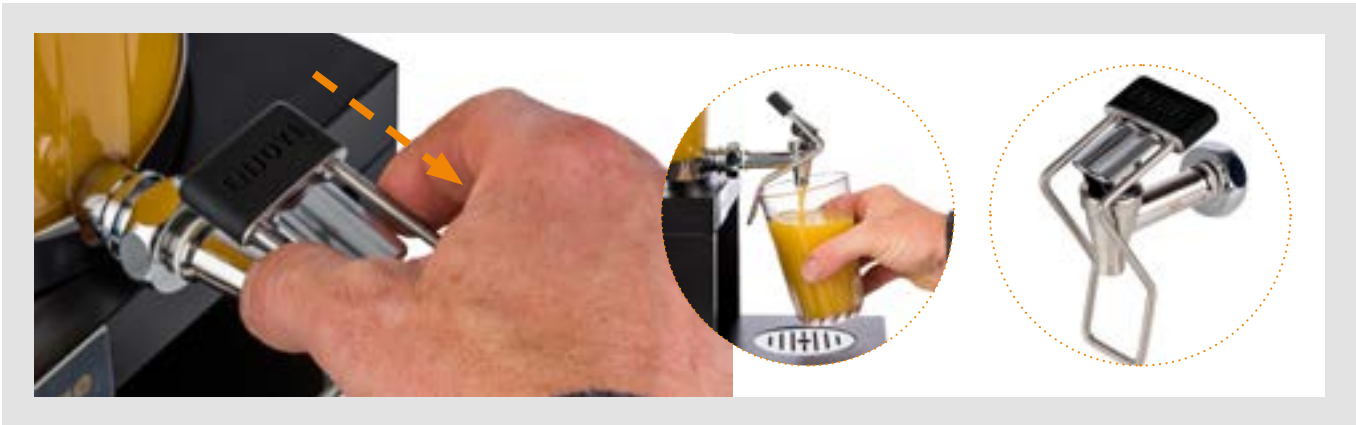

Der Adapter passt auf alle Dispenser der Serien TOP FRESH, BRIDGE und SUNDAY und kann ganz einfach installiert werden.

The adapter fits all dispensers of the series TOP FRESH, BRIDGE and SUNDAY and can be installed very easily.

El adaptador se adapta a todos los dispensadores de las series TOP FRESH, BRIDGE y SUNDAY y puede ser instalado fácilmente.

L'adaptateur s'adapte à tous les distributeurs des séries TOP FRESH, BRIDGE et SUNDAY et peut être installé très facilement.

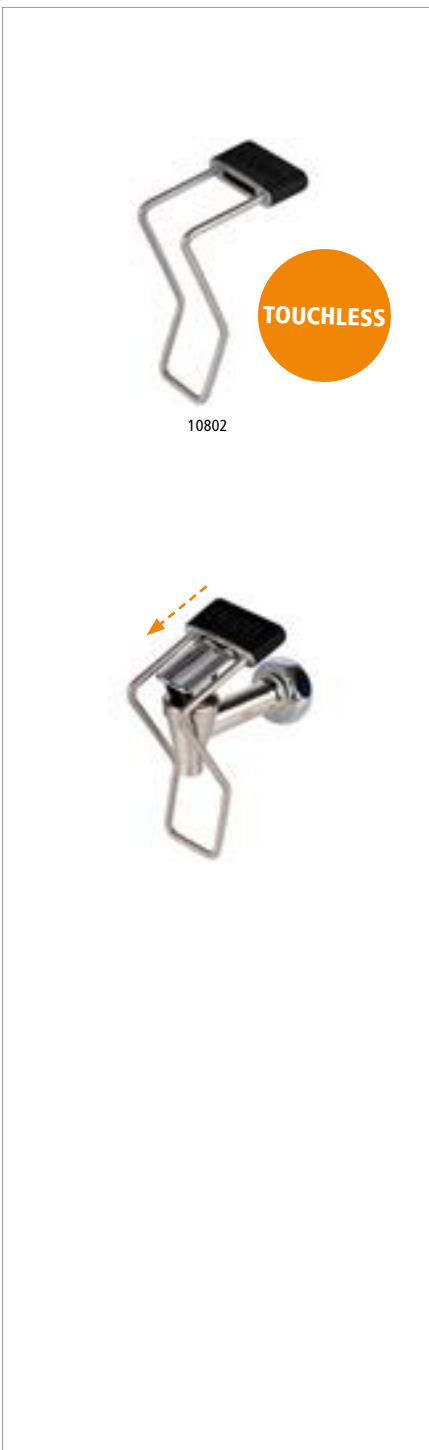

**Adapter „TOP FRESH“**

adapter  
adaptador  
adaptateur



handkontaktloser Adapter, einfach zu installieren

adapter touchless for tap, easy to install

adaptador sin contacto para grifo

adaptateur sans contact manuel, facile à installer

	cm	↑ cm
10802	12 x 4,5	5,5



Einfach den Adapter an der dafür vorgesehenen Öffnung auf den Hebel des Zapfhahns stecken.

Simply plug the adapter onto the lever of the tap at the opening provided.

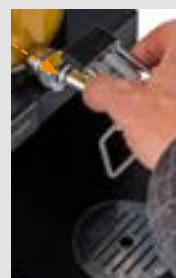

Anschließend den Adapter nach unten festziehen. Durch das Nach-Vorne-Drücken des unteren Edelstahlbügels mit Hilfe des Glases, wird der Hebel des Zapfhahns betätigt und das Getränk fließt völlig handkontaktlos in das Glas.

Then tighten the adapter downwards. By pushing the lower stainless steel bracket forward with the help of the glass, the lever of the tap is activated and the drink flows into the glass completely without hand contact.

passend für / suitable for:



Saftdispenser „TOP FRESH“  
Katalog Seite 41  
juice dispenser,  
catalogue page 41



Milchkanne „TOP FRESH“  
Katalog Seite 45  
milk dispenser,  
catalogue page 45



Saftdispenser „BRIDGE“  
Katalog Seite 20  
juice dispenser,  
catalogue page 20

## BEVERAGE DISPENSERS



### Saftdispenser „TOWER“

juice dispenser  
dispensador de zumo  
distributeur à jus de fruit

aus Edelstahl, inklusive Crushed Ice Röhre

made of stainless steel, inclusive crushed ice tube  
de acero inoxidable con tubo para hielo picado  
en acier inox avec tube de glace pilée



5 ltr.

	cm	↑ cm	ltr.
10440	35 x 23	75	5



Edelstahl Zapfhahn  
stainless steel tap



### Milchdispenser „BRIDGE“

milk dispenser  
dispensador de leche  
distributeur à lait

massives Buchenholz gebeizt, Edelstahldispenser mit 1 Kühlakku im Standfuß inklusive touchless adapter

solid beech wood, stained, stainless steel dispenser with 1 cooler in stand including touchless adapter

madera de haya maciza teñida, dispensador de acero inoxidable con 1 acumulador de frío en la base y con adaptador sin contacto para grifo

bois de hêtre massif teinté, distributeur en acier inox avec 1 accumulateur de froid dans le socle et avec adaptateur sans contact manuel



	cm	↑ cm	ltr.	Farbe / Colour
10837	31 x 20	39	3	■
10839	39 x 22	45	5	■



### Milchdispenser „BRIDGE“

milk dispenser  
dispensador de leche  
distributeur à lait

massives Ahornholz, Edelstahldispenser mit 1 Kühlakku im Standfuß inklusive touchless adapter

solid maple wood, stainless steel dispenser with 1 cooler in stand including touchless adapter  
madera maciza de arce, dispensador de acero inoxidable con 1 acumulador de frío en la base y con adaptador sin contacto para grifo

bois d'érable massif, distributeur en acier inox avec 1 accumulateur de froid dans le socle et avec adaptateur sans contact manuel



	cm	↑ cm	ltr.	Farbe / Colour
10836	31 x 20	39	3	■
10838	39 x 22	45	5	■



**Saftdispenser „BRIDGE“**

juice dispenser  
dispensador de zumo  
distributeur à jus



**Kühlung durch 2 Kühllakkus von oben und unten**

cooling with 2 coolers from the top and base

2 acumuladores de frío: 1 en la base y 1 en la tapa

2 accumulateurs de froid: 1 dans le couvercle, 1 dans le socle

	cm	↑ cm	ltr.	Farbe / Colour
10872	31,0 x 20	42	4	■
10873	35,5 x 22	50	6	■



inklusive 3 Magnetschilder: ORANGE, APPLE, GRAPEFRUIT  
including 3 magnetic signs: ORANGE, APPLE, GRAPEFRUIT



**Saftdispenser „BRIDGE“**

juice dispenser  
dispensador de zumo  
distributeur à jus



**Kühlung durch 2 Kühllakkus von oben und unten**

cooling with 2 coolers from the top and base

2 acumuladores de frío: 1 en la base y 1 en la tapa

2 accumulateurs de froid: 1 dans le couvercle, 1 dans le socle

	cm	↑ cm	ltr.	Farbe / Colour
10870	31,0 x 20	42	4	■
10871	35,5 x 22	50	6	■



inklusive 3 Magnetschilder: ORANGE, APPLE, GRAPEFRUIT  
including 3 magnetic signs: ORANGE, APPLE, GRAPEFRUIT



**Milchkanne „TOP FRESH“**

milk dispenser  
dispensador de leche  
distributeur à lait



**hochglanzpoliert, 1 Kühllakku im Standfuß, „original Milchkanne mit Henkel“**

mirror polished, 1 cooler in base, original milkcan

pulido brillante, 1 acumulador de frío en la base, recipiente „lechera“

poli brillant, 1 accumulateur de froid dans le socle, design „pot à lait“

	cm	↑ cm	ltr.
10830	21 x 32	39	3
10750	23 x 35	45	5

**Milchkanne ohne Zapfhahn / milkcan without tap / jarra de leche sin grifo / récipient à lait sans robinet**

	Ø cm	↑ cm	ltr.
10833	16	22	3
10663	22	26	5

## BEVERAGE DISPENSERS



### Milchkanne „TOP FRESH“

milk dispenser  
dispensador de leche  
distributeur à lait



**inklusive Porzellanschild zum Beschriften, 1 Kühlakku im Fuß**

including porcelain sign, 1 cooler in base  
incluye cartelito en porcelana, 1 acumulador de frío en la base  
indicateur en porcelaine inclus, 1 accumulateur de froid dans le socle

	cm	↑ cm	ltr.
10850	31 x 21	42	4



### Milchkanne „TOP FRESH“

milk dispenser  
dispensador de leche  
distributeur à lait



**Buchenholz versiegelt, inklusive Porzellanschild zum Beschriften, 1 Kühlakku im Fuß**

beech wood, waterproof, incl. porcelain sign, 1 cooler in base  
madera de haya, resistente al agua, incluye placa de porcelana, 1 acumulador de frío en la base  
socle bois hêtre traité, indicateur en porcelaine inclus, 1 accumulateur de froid dans le socle

	cm	↑ cm	ltr.
10840	23 x 32,0	42	4
10757	27 x 38,5	45	8

**Milchkanne Porzellan, ohne Zapfhahn / milkan porcelain, without tap / jarra de leche sin grifo / récipient en porcelaine sans robinet**

	Ø cm	↑ cm	ltr.
10825	18	25	4
10758	22	26	8

**Deckel für 10840, 10850 / cover for 10840, 10850 / tapa para 10840, 10850 / couvercle pour 10840, 10850**

10859

**Deckel für 10757 / cover for 10757 / tapa para 10757 / couvercle pour 10757**

10759

**Schild und Kette / shield and chain / placa y cadena / indicateur porcelaine avec chaînette**

10756

**Zapfhahn / tap / grifo / robinet**

10907



**Kaffeedispenser „HAPPY HOUR“**

coffee dispenser  
dispensador de café  
distributeur de café



hochglanzpoliert, für warme Getränke, stabil und standfest, inklusive 1 Brennpastenbehälter  
mirror polished, for warm drinks, solid and stable, including 1 burner holder  
pulido brillante, para bebidas calientes, sólido y estable, incluye un calentador  
poli brillant, pour boissons chaudes, robuste et stable, avec 1 brûleur

	cm	↑ cm	ltr.
11672	31 x 33,5	54,5	10,5

Hahn / tap / grifo / robinet

11671

Elektro-Heizelement / heating unit / resistencia / résistance

	cm	↑ cm
12287	21 x 20	6



**Pump-Isolierkanne „PREMIUM“**

air pot  
jarra termo  
bouteille isotherme



matt poliert, doppelwandig, Tragegriff, Drehverschluss, Pumpmechanismus, Füllstandsanzeigefür heiße und kalte Getränke, inklusive 4 Beschriftungsclips, für 24 Tassen

matt polished, double-walled, carrying handle, screw cap, pump mechanism, fill level indicator, for hot and cold beverages, including 4 beverage signs, for 24 cups

pulido mate, doble pared, asa de transporte, tapón de rosca, mecanismo de bombeo, indicador de nivel para bebidas calientes y frías, con 4 clips para marcar, para 24 tazas

poli mat, double paroi, poignée de transport, fermeture rotative, mécanisme de pompage, indicateur de niveau pour boissons chaudes et froides, avec 4 clips d'inscriptions, pour 24 tasses

	Ø cm	↑ cm	ltr.	Anzahl der Tassen
10916	15	37	3	24

Tropfenfänger für Pump-Isolierkanne / drip tray for air pot / recoge gotas para jarra termo / ramasse-gouttes pour bouteilles isotherme

	cm	↑ cm
10917	24 x 18,5	4



**Pump-Isolierkanne „BUDGET“**

air pot  
jarra termo  
bouteille isotherme



Edelstahl, Polypropylen, matt poliert, doppelwandig, Tragegriff, Dreh-Pumpknopf, für heiße und kalte Getränke, für 17 Tassen

stainless steel, polypropylene, matt polished, double-walled, carrying handle, push-button, for hot and cold beverages, for 17 cups

acero inoxidable, polipropileno, pulido mate, doble pared, asa de transporte, botón giratorio de la bomba, para bebidas calientes y frías, para 17 tazas

acier inox, polypropylène, poli mat, double paroi, poignée de transport, bouton de pompage rotatif, pour boissons chaudes et froides, pour 17 tasses

	Ø cm	↑ cm	ltr.	Anzahl der Tassen
10915	13,5	32,5	2,2	17

# VACUUM JUGS



## Isolierkanne „ADVANCED“

vacuum jug  
jarra termo  
bouteille isotherme



doppelwandig, spülmaschinenfest, Einhandautomatik, aufgeklappt passt die Kanne unter die gängigen Kaffeeautomaten, für heiße und kalte Getränke

double-walled, dishwasher-safe, easy pouring system, with flipped-back lid, the air pot fits under a wide range of coffee makers, for hot and cold beverages

doble pared, resistente al lavavajillas, se maneja con 1 mano, con la tapa abierta la jarra se puede usar con casi todas las cafeteras corrientes, para bebidas frías y calientes

double paroi, résistante au lave-vaisselle, usage à 1 main, avec la couvercle ouverte a bouteille se peut user avec toutes les machines à café courantes, pour boissons chaudes ou froides

	Ø cm	↑ cm	ltr.	Anzahl der Tassen
10921	10,5	13,0	0,3	2,5
10922	10,5	18,0	0,6	5,0
10923	13,0	19,5	1,0	8,0
10924	13,0	23,5	1,5	12,0



Deckel klappbar  
lid foldable



## Schutzmantel „HOT WATER“

protective coat  
funda protectora  
housse de protection



aus braunem Kunstleder, mit Kennzeichnung „HOT WATER“

made of brown imitation leather, with marking „HOT WATER“

imitación cuero marrón, con marcaje „HOT WATER“

en similicuir marron, avec marquage „HOT WATER“



	cm	↑ cm	Farbe / colour	fits to
10925	16 x 16	1	■	10922
10927	20 x 20	1	■	10924



## Schutzmantel „BLACK COFFEE“

protective coat  
funda protectora  
housse de protection



aus schwarzem Kunstleder, mit Kennzeichnung „BLACK COFFEE“

made of black imitation leather, with marking „BLACK COFFEE“

imitación cuero negro, con marcaje „BLACK COFFEE“

en similicuir noir, avec marquage „BLACK COFFEE“



	cm	↑ cm	Farbe / colour	fits to
10926	16 x 16	1	■	10922
10928	20 x 20	1	■	10924





**Isolierkanne „VEGAN ADVANCED“**

vacuum jug  
jarra termo  
bouteille isotherme

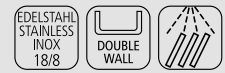

**doppelwandig, spülmaschinenfest, Einhandautomatik, aufgeklappt passt die Kanne unter die gängigen Kaffeeautomaten, für heiße und kalte Getränke, mit Gravur „VEGAN“**

double-walled, dishwasher-safe, easy pouring system, with flipped-back lid, the air pot fits under a wide range of coffee makers, for hot and cold beverages, with engraving „VEGAN“  
doble pared, resistente al lavavajillas, se maneja con 1 mano, con la tapa abierta la jarra se puede usar con casi todas las cafeteras corrientes, para bebidas frías y calientes, con grabado „VEGAN“  
double paroi, résistante au lave-vaisselle, usage à 1 main, avec la couvercle ouverte a bouteille se peut user avec toutes les machines à café courantes, pour boissons chaudes ou froides, avec gravure „VEGAN“

	Ø cm	↑ cm	ltr.	Anzahl der Tassen
10353	10,5	18,0	0,6	5,0
10354	13,0	19,5	1,0	8,0



**Isolierkanne „CLASSIC“**

vacuum jug  
jarra termo  
bouteille isotherme



**doppelwandig, Einhandautomatik, Drehverschluss, für heiße und kalte Getränke, mit Gravur „VEGAN“**  
double-walled, easy push-button pouring system, screw cap, for hot and cold drinks, with engraving „VEGAN“

doble pared, se maneja con 1 mano, con tapa a rosca, para bebidas frías y calientes, con grabado „VEGAN“  
double paroi, usage à 1 main, couvercle à visser, pour boissons chaudes ou froides, avec gravure „VEGAN“

	Ø cm	↑ cm	ltr.	Anzahl der Tassen
10910	14	19	1,0	8
10911	14	22	1,5	12
10912	14	25	2,0	16



**Isolierkanne „VEGAN CLASSIC“**

vacuum jug  
jarra termo  
bouteille isotherme



**doppelwandig, Einhandautomatik, Drehverschluss, für heiße und kalte Getränke**  
double-walled, easy push-button pouring system, screw cap, for hot and cold drinks

doble pared, se maneja con 1 mano, con tapa a rosca, para bebidas frías y calientes  
double paroi, usage à 1 main, couvercle à visser, pour boissons chaudes ou froides

	Ø cm	↑ cm	ltr.
10352	14	19	1,0

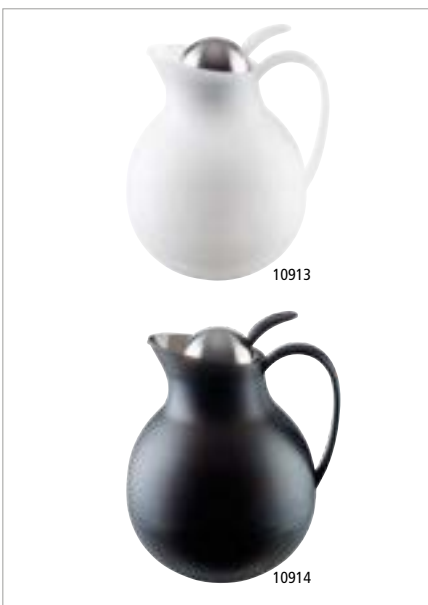

**Isolierkanne „ECONOMY“**

vacuum jug  
jarra termo  
bouteille isotherme



**robuste Umhüllung mit Polypropylen-Kunststoff, Stabilglaseinsatz, Drehverschluss mit Drucktasten-Bedienung für heiße und kalte Getränke, 8 Tassen**

double-walled with glass liner, screw cap with easy push-button pouring system, for hot and cold beverages, 8 cups

exterior de plástico polipropileno, interior aislante de vidrio, con tapa a rosca con cierre dosificador para bebidas frías y calientes, 8 tazas

extérieur en plastique polypropylène, intérieur avec plaque de verre, couvercle à visser, pour boissons chaudes ou froides, 8 tasses

	Ø cm	↑ cm	ltr.	Farbe / Colour
10913	16	20	1	White
10914	16	20	1	Black

# CARAFES



**3 tlg.  
3 pcs.**

**1,4 ltr.**

## Kühlkaraffe, 3-teilig „COOL“

cooling carafe, 3 pcs.

jarra fría, set de 3

pichet rafraîchisseur, set de 3

**1 Glaskaraffe mit Edelstahl Ausgießer, öffnet und schließt selbstständig + 1 verchromter Fuß + 1 Kühllakku, werden bis zu 4 Stunden gekühlt**

1 glass carafe with stainless steel pourer, open / closing autonomous + 1 chrome plated base + 1 cooling pack, up to 4 hours cooled beverages

1 botella de vidrio con vertedor inox, con autocierre + 1 base cromada + 1 acumulador de frío que mantiene las bebidas frescas hasta unas 4 horas

1 pichet en verre avec insert verseur inox, fermeture automatique + 1 socle chromé + 1 accumulateur de froid pour maintenir les boissons froides jusqu'à 4 heures



	Ø cm	↑ cm	ltr.
10762	16	27	1,4



**Edelstahlausgießer**  
stainless steel pourer



**Kühlstation inklusive Kühllakku (schwarz)**  
including cooler (black)

**1,0 ltr.**

## Glaskaraffe

glass carafe

jarra de vidrio

pichet en verre

**der Deckel öffnet sich beim Ausgießen automatisch**

cover opens automatically while pouring

la tapa se abre automáticamente durante el vertido

le couvercle s'ouvre seul pendant le service



	Ø cm	↑ cm	ltr.
10766	9,5	29	1

**1,5 ltr.**

## Saft- / Wasserkanne

juice / water pitcher

jarra de zumo / agua

pichet à eau ou jus de fruit

**Deckel aus Edelstahl matt poliert, Ausgießer für tropffreies Ausgießen**

stainless steel cover, matt polished, spout for drip-free pouring

tapa de acero inoxidable pulido mate, pico para verter sin gotear

couvercle en acier inox poli mat, bec verseur pour verser sans goutter



	Ø cm	↑ cm	ltr.
10764	9,5	27	1,5



**Glaskaraffe**  
glass carafe  
jarra de vidrio  
carafe en verre



**Deckel aus Edelstahl matt poliert, mit integriertem Auffangsieb für Kerne oder Eis**  
lid made of matt polished stainless steel, with integrated strainer for cores or ice  
tapa de acero inoxidable pulido mate, con filtro integrado para los huesos o el hielo  
couvercle en acier inox poli mat, avec filtre intégré pour les pépins ou la glace

	Ø cm	↑ cm	litr.
10792	10	26	1,5



**Deckel mit Doppelfunktion**  
lid with double function

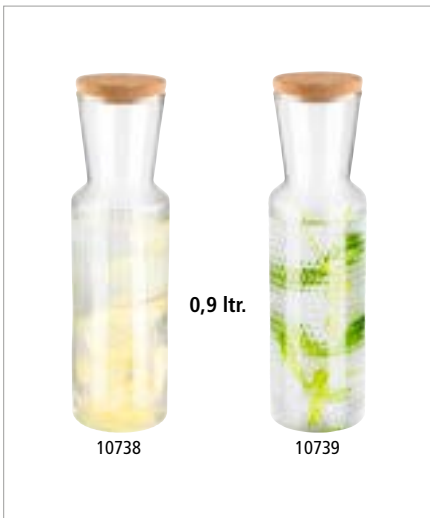

**Glaskaraffe**  
glass carafe  
jarra de vidrio  
carafe en verre



	Ø cm	↑ cm	litr.	Design
10738	8	27	0,9	LINES
10739	8	27	0,9	DOTS



**Detailansicht**  
detail view „LINES“

**Detailansicht**  
detail view „DOTS“

**inklusive Korkdeckel**  
incl. cork cover



**Glaskaraffe**  
glass carafe  
jarra de vidrio  
carafe en verre



	Ø cm	↑ cm	litr.	Design
10741	8	28	0,8	COMB
10742	8	28	0,8	DIAMOND



**Detailansicht**  
detail view „COMB“

**Detailansicht**  
detail view „DIAMOND“

**inklusive Holzkorken mit Silikondichtung**  
including wooden cork with silicone gasket



**Glaskaraffe**  
glass carafe  
jarra de vidrio  
carafe en verre



**Deckel aus Edelstahl matt poliert, Ausgießer für tropffreies Ausgießen**  
lid made of matt polished stainless steel, spout for drip-free pouring  
tapa de acero inoxidable pulido mate, pico para verter sin gotear  
couvercle en acier inox poli mat, bec verseur pour verser sans goutter

	Ø cm	↑ cm	litr.
10721	8	25	1,0
10722	8	32	1,3

## CARAFES



### Glaskaraffe „OLD FASHIONED“, 2 teilig

glass carafe, 2 pcs.  
jarra de vidrio, set de 2  
carafe en verre, set de 2

1 Flasche 1,0 ltr., 1 Glas 0,3 ltr.  
1 bottle 1,0 ltr., 1 glass 0,3 ltr.  
1 botella 1,0 ltr., 1 vaso 0,3 ltr.  
1 bouteille 1,0 ltr., 1 verre 0,3 ltr.



	Ø cm	↑ cm	ltr.
10690	9,5	31	1,0

Ersatzglas / replacement glass / vaso de recambio / verre de remplacement

	Ø cm	↑ cm	ltr.	VE / unit
10520	8	12,5	0,3	6



### Glaskaraffe „OLD FASHIONED“

glass carafe  
jarra de vidrio  
carafe en verre

Deckel mit Auffangsieb für Kerne oder Eis  
lid with integrated strainer for cores or ice  
tapa con filtro integrado para los huesos o el hielo  
couverture avec filtre intégré pour les pépins ou la glace



	Ø cm	↑ cm	ltr.
10691	12	26	1,8



### Buffetbrett

buffet board  
tabla de buffet  
planche de buffet

für Karaffen, mit 3 Einsätzen Ø 11 cm aus Kunstleder, aus geöltem Eichenholz  
for carafes, with 3 leatherette inserts Ø 11 cm, made of oiled oak wood  
para jarras, con 3 inserciones de imitación de cuero Ø 11 cm, de madera de roble aceitada  
pour pichets, avec 3 inserts en similicuir Ø 11 cm, en bois de chêne huilé



	cm	↑ cm	Farbe / Colour
11705	47 x 19	2	natural oak
11706	47 x 19	2	dark oak

6 Einsätze aus Kunstleder / 6 leatherette inserts / 6 inserciones de imitación de cuero / 6 inserts en similicuir

	Ø cm	Farbe / Colour	pcs.
35716	11	anthracite	6



Kunstledereinsatz herausnehmbar  
removable leatherette insert



### Saft- / Wasserkanne

juice / water pitcher  
jarra de zumo / agua  
pichet à eau ou jus de fruit

mit Eiswasserröhre  
with water ice tube  
con tubo para hielo  
avec tube à glaçons plongeant pour réfrigérer



	Ø cm	↑ cm	ltr.
10770	18	29	3



**Soft- / Wasserkanne**  
 juice / water pitcher  
 jarra de zumo / agua  
 pichet à eau ou jus de fruit



	Ø cm	↑ cm	ltr.
10775	12	26	2



**Soft- / Wasserkanne**  
 juice / water pitcher  
 jarra de zumo / agua  
 pichet à eau ou jus de fruit



	Ø cm	↑ cm	ltr.
10776	14	29	2,5



**Flasche „STRIPES“**  
 bottle  
 botella  
 bouteille



	Ø cm	↑ cm	ltr.	Farbe / colour
10748	9	28,5	1	
10749	9	28,5	1	



**Soft- / Wasserkanne**  
 juice / water pitcher  
 jarra de zumo / agua  
 pichet à eau ou jus de fruit  
**mit Eiswasserröhre**  
 with water ice tube  
 con tubo para hielo  
 avec tube à glaçons plongeant pour réfrigérer



	cm	↑ cm	ltr.
10769	19 x 13	27	2,8



**Karaffe**  
 bottle  
 botella  
 bouteille



**Schraubdeckel mit aromadichtem Verschluss**  
 screwed lid, aroma-tight  
 tapón de rosca, impide la fuga de aromas  
 bouchon à visser, ne laisse pas passer les arômes

	Ø cm	↑ cm	ltr.	Farbe / Colour
10771	11	30	1,6	

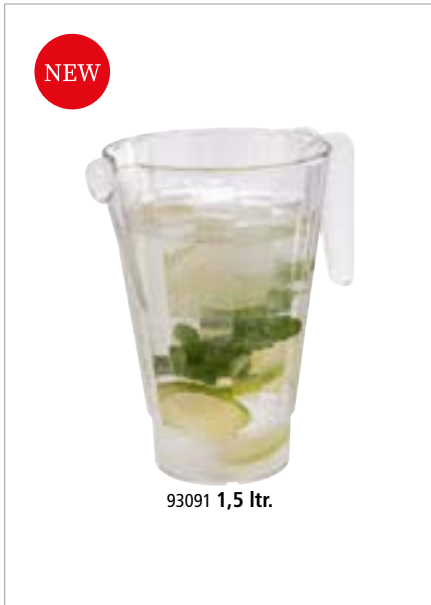

Pitcher  
pitcher  
jarra  
pichet



	Ø cm	↑ cm	ltr.
93090	12,5	17,5	1,0
93091	13,5	20,0	1,5

passende Deckel / fitting lids / tapa adecuadas / couvercles appropriées

	cm	↑ cm	fits to
93092	13,0	1,5	93090
93093	14,0	1,5	93091

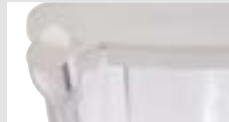

Deckel mit Klappe  
lid with flap



einfaches Eingießen  
easy pouring



stapelbar  
stackable



Pitcher  
pitcher  
jarra  
pichet



	Ø cm	↑ cm	ltr.
93105	13	21	1,5



Kühlbox „FROSTY“  
bottle cooler  
enfriador de botellas  
rafraichisseur de bouteilles



mit herausnehmbarem Einsatz für 4 Flaschen  
with removable insert for 4 bottles  
con inserto extraíble para 4 botellas  
avec insert amovible pour 4 bouteilles



Abb. ohne Einsatz  
illustration without insert

	cm	↑ cm	ltr.	hole ø cm
93230	27 x 27	15	7,5	11



Flaschenkühler „BIG BOWL“  
bottle cooler  
enfriador de botella  
rafraichisseur de bouteille



gehämmerte Oberfläche, innen mattiert, herausnehmbarer Tropfeinsatz  
hammered surface, matted inside, removable drip tray  
superficie martillada, interior mate, bandeja de goteo extraíble  
surface martelée, intérieur mat, bac de récupération amovible

	Ø cm	↑ cm	ltr.
36130	37	23	8





36111 7 ltr.

36112 7 ltr.

Wein- / Sektkühler „XL“

wine / champagne bowl  
cubitera para vino y cava  
seau à vin ou champagne

gehämmerte Oberfläche, mit 2 seitlichen Eingriffen

hammered surface, with 2 handles on the side

superficie martillada, con 2 asas

surface martelée, avec 2 poignées



	cm	↑ cm	ltr.	Farbe / Colour
36111	30 x 23,5	23	7	copper-look
36112	30 x 23,5	23	7	gunmetal-look



NEW

36109 3,9 ltr.

36108 3,9 ltr.

Wein- / Sektkühler „LARGE“

wine / champagne bowl  
cubitera para vino y cava  
seau à vin ou champagne

gehämmerte Oberfläche, mit 2 seitlichen Eingriffen, für 1-2 Flaschen

hammered surface, with 2 handles on the side, for 1-2 bottles

superficie martillada, con 2 asas, para 1-2 botellas

surface martelée, avec 2 poignées, pour 1-2 bouteilles



	cm	↑ cm	ltr.	Farbe / Colour
36108	25,5 x 19	20	3,9	copper-look
36109	25,5 x 19	20	3,9	gunmetal-look



NEW

36106 2,1 ltr.

36107 2,1 ltr.

Wein- / Sektkühler „SMALL“

wine / champagne bowl  
cubitera para vino y cava  
seau à vin ou champagne

gehämmerte Oberfläche, für 1 Flasche

hammered surface, for 1 bottle

superficie martillada, para 1 botella

surface martelée, pour 1 bouteille



	cm	↑ cm	ltr.	Farbe / Colour
36106	20,5 x 14	17	2,1	copper-look
36107	20,5 x 14	17	2,1	gunmetal-look



36100 11 ltr.

36095 11 ltr.

Getränkewanne „TIN“

beverage tub  
barreño botellines  
bassine à glace

Metall verzinkt, mit Kunststoffeinsatz

galvanised metal, with plastic insert

metal galvanizado, con inserto de plástico

métal galvanisé, avec insert en plastique



	cm	↑ cm	ltr.	Farbe / Colour
36100	40 x 28	22	11	copper-look
36101	40 x 28	22	11	black-metal-look
36095	40 x 28	22	11	metal-look
36096	50 x 23	23	18	metal-look



mit Kunststoffeinsatz  
with plastic insert  
con inserto de plástico  
avec insert en plastique



71490

Kreidestift zum  
Beschriften | chalk  
marker for writing  
S. 304

# CONFERENCE



## Flaschenkühler „CONFERENCE“

conference bottle cooler  
enfriador múltiple  
rafraîchisseur



inklusive Kühllakku, Flaschenöffner, Kronkorkenschale,  
mit 6 Öffnungen Ø 6,7 cm für 0,25 - 0,5 Liter-Flaschen

incl. bottle cooler, bottle opener, small cap bowl,  
with 6 holes Ø 6,7 cm for 0,25 to 0,5 liter bottles

con acumulador de frío, abridor, recuperador de chapas,  
6 plazas Ø 6,7 cm, para botellas de 0,25 a 0,5 ltr.

avec accumulateur de froid, décapsuleur, bol récupérateur  
de capsules, 6 places Ø 6,7 cm, pour bouteilles de 0,25 à 0,5 litres

	Ø cm	↑ cm	Farbe / Colour
00620	23	15	■
00621	23	15	■



## Kühllakku

cooler  
acumulador de frío  
accumulateur de froid



	Ø cm	→ cm	Farbe / Colour
00615	7,5	11,5	■



## Flaschenöffner

bottle opener  
abridor  
décapsuleur



	Ø cm	→ cm
00617	1	13,5



## Kronkorkenschale

cap bowl  
cuenco para chapas  
bol récupérateur de capsules



	Ø cm	↑ cm	Farbe / Colour
00618	6,5	3	■
00619	6,5	3	■



## TEAPOTS



NEW



10995 0,8 ltr.



10996 0,8 ltr.

mit Teesieb / with tea strainer

## Teekanne „ASIA“

teapot  
tetera  
théière

aus Gusseisen, innen emailliert, abnehmbarer Deckel, mit Teesieb aus Edelstahl

made of cast iron, enamelled inside, removable lid, with tea strainer made of stainless steel

hierro fundido, interior esmaltado, tapa extraíble, con colador de té de acero inoxidable

en fonte, émaillé à l'intérieur, couvercle amovible, avec une passoire à thé en acier inox

	cm	↑ cm	ltr.	Farbe / Colour
10995	17 x 14	17	0,8	■
10996	17 x 14	17	0,8	■



10991 0,8 ltr.



10992 0,8 ltr.

mit Teesieb / with tea strainer

## Teekanne „ASIA“

teapot  
tetera  
théière

aus Gusseisen, innen emailliert, mit abnehmbarem Deckel,

inklusive Teesieb aus Edelstahl, ideal für 2-3 Tassen. Geeignet für alle Herdarten.

made of cast iron, enamelled inside, with removable lid, incl. tea strainer made of stainless steel, ideal for 2-3 cups. Suitable for all types of stoves.

hierro fundido, interior esmaltado, con tapa extraíble, incl. colador de té de acero inoxidable, ideal para 2-3 tazas. Apta para todas las placas de cocina.

en fonte, émaillé à l'intérieur, avec couvercle amovible, y compris une passoire à thé en acier inox, idéale pour 2-3 tasses. Convient à tous les types de feux (gaz, vitro ou induction).

	cm	↑ cm	ltr.	Farbe / Colour
10991	19,5 x 18	15	0,8	■
10992	19,5 x 18	15	0,8	■



0,3 ltr.

ohne Teesieb / without tea strainer

## Teekanne „ASIA“

teapot  
tetera  
théière

aus Gusseisen, innen emailliert, mit abnehmbarem Deckel, ohne Teesieb aus Edelstahl

made of cast iron, enamelled inside, with removable lid, without tea strainer made of stainless steel

hierro fundido, interior esmaltado, con tapa extraíble, sin colador de té de acero inoxidable

en fonte, émaillé à l'intérieur, avec couvercle amovible, sans une passoire à thé en acier inox

	cm	↑ cm	ltr.	Farbe / Colour
10990	12,5 x 11	12,5	0,3	■

## TEAPOTS



### Stövchen „ASIA“

teapot warmer  
calentador de tetera  
chauffe-théière



**1-flammiges Stövchen aus Gusseisen mit abnehmbarem Deckel (Lieferung ohne Teelicht).**

1-flame cast iron warmer with removable lid (delivery without tealight).

calentador de tetera de hierro fundido con 1 quemador con tapa extraíble (se entrega sin vela).

chauffe-théière en fonte à 1 brûleur avec couvercle amovible (livraison sans bougie).

	Ø cm	↑ cm	Farbe / Colour
10994	13	7,5	■

**Untersetzer aus Gusseisen mit Antirutschfüßchen / cast iron coaster with non-slip feet**

	Ø cm	↑ cm	Farbe / Colour
10993	13,5	1,5	■



### Teebox

tea-box  
caja para té  
boîte à thés et infusions



**Box aus Rubberwood mit Sichtfenster, mit Aufschrift „Tee“, 4 Kammern können mit je 30 kuvertierten Teebeuteln bestückt werden**

rubber wood box with clear transparent window, with inscription „Tee“, 4 chambers for approx. 30 tea bags each

caja de madera de goma clara con ventana transparente, con inscripción „Tee“, 4 compartimentos, y cada uno para aproximadamente 30 bolsitas de té

en bois d'hévéa clair avec fenêtre, avec inscription „Tee“, 4 compartiments, pour environ 30 sachets chacun

4 compartiments, pour environ 30 sachets chacun

	cm	↑ cm	Farbe / Colour
11575	33,5 x 20	9	■
11574	33,5 x 20	9	■

	cm	↑ cm	Farbe / Colour	
11576	33,5 x 20	9	■	ohne Aufschrift / without inscription sin inscripción / sans inscription



### Teebox

tea-box  
caja para té  
boîte à thés et infusions



**Box aus Rubberwood mit Sichtfenster, mit Aufschrift „Tee“, 12 Kammern können mit je 12 kuvertierten Teebeuteln bestückt werden**

rubber wood box with clear transparent window, with inscription „Tee“, 12 chambers for approx. 12 tea bags each

caja de madera de goma clara con ventana transparente, con inscripción „Tee“, 12 compartimentos, y cada uno para aproximadamente 12 bolsitas de té

en bois d'hévéa clair avec fenêtre, avec inscription „Tee“, 12 compartiments, pour environ 12 sachets chacun

12 compartiments, pour environ 12 sachets chacun

	cm	↑ cm	Farbe / Colour
11775	31 x 28	9	■
11776	31 x 28	9	■



### Teebox / Multibox

tea caddy  
caja para té  
boîte à thés et infusions



**3 Fächer für kuvertierte Teebeutel, 1 Fach für Zucker, Kekse, etc., Deckel aufklappbar**

3 compartments for tea bags, 1 compartment for sugar, biscuits, etc., hinged lid

3 compartimentos para bolsitas de té, 1 compartimento para azúcar, galletas, etc. tapa abatible

3 compartiments pour sachets de thé, 1 compartiment pour sucre, biscuits, etc., couvercle abatible

	cm	↑ cm
11563	22 x 17	9

# CEREAL DISPENSERS



4,5 ltr.

## Cerealienspender „FRESH & EASY“

cereal dispenser  
dispensador de cereales  
distributeur de céréales

Black  
&  
beautiful

SAN  
KUNSTSTOFF

SILIKON  
SILICON

GUSS  
ZINK

EDELSTAHL  
STAINLESS  
INOX

Behälter herausnehmbar, „Feierabend-Deckel“ für das aromadichte Lagern,  
portionieren durch einfaches Drehen

removable canister, special lid to keep the cereals fresh, easy to use, rotate the button  
to get the muesli

contenedor extraíble, tapa especial para mantener los cereales frescos, fácil de usar,  
se gira el pomo para servir los cereales

réceptif amovible, couvercle spécial pour conserver les céréales,  
usage facile en tournant le bouton

	cm	↑ cm	ltr.	Farbe / Colour
11840	22 x 17,5	52	4,5	■



2 x 4,5 ltr.

## Cerealienspender Duo „FRESH & EASY“

cereal dispenser  
dispensador de cereales  
distributeur de céréales

Black  
&  
beautiful

SAN  
KUNSTSTOFF

SILIKON  
SILICON

GUSS  
ZINK

EDELSTAHL  
STAINLESS  
INOX

Behälter herausnehmbar, „Feierabend-Deckel“ für das aromadichte Lagern,  
portionieren durch einfaches Drehen

removable canister, special lid to keep the cereals fresh, easy to use, rotate the button  
to get the muesli

contenedor extraíble, tapa especial para mantener los cereales frescos, fácil de usar,  
se gira el pomo para servir los cereales

réceptif amovible, couvercle spécial pour conserver les céréales, usage facile en  
tournant le bouton

	cm	↑ cm	ltr.	Farbe / Colour
11841	22 x 35	52	2 x 4,5	■

## CEREAL DISPENSERS



### Cerealienspender „FRESH & EASY“

cereal dispenser  
dispensador de cereales  
distributeur de céréales



**Behälter herausnehmbar, „Feierabend-Deckel“ für das aromadichte Lagern, portionieren durch einfaches Drehen**

removable canister, special lid to keep the cereals fresh, easy to use, rotate the button to get the muesli  
contenedor extraíble, tapa especial para mantener los cereales frescos, fácil de usar, se gira el pomo para servir los cereales  
récipient amovible, couvercle spécial pour conserver les céréales, usage facile en tournant le bouton

	cm	↑ cm	ltr.
11805	22 x 17,5	52	4,5



### Cerealienspender Duo „FRESH & EASY“

cereal dispenser  
dispensador de cereales  
distributeur de céréales



**Behälter herausnehmbar, „Feierabend-Deckel“ für das aromadichte Lagern, portionieren durch einfaches Drehen**

removable canister, special lid to keep the cereals fresh, easy to use, rotate the button to get the muesli  
contenedor extraíble, tapa especial para mantener los cereales frescos, fácil de usar, se gira el pomo para servir los cereales  
récipient amovible, couvercle spécial pour conserver les céréales, usage facile en tournant le bouton

	cm	↑ cm	ltr.
11807	22 x 35	52	2 x 4,5



### Cerealienspender „ROTATION“

cereal dispenser  
dispensador de cereales  
distributeur de céréales



**matt poliert, drehbarer massiver Ständer, Behälter herausnehmbar, inklusive Frischhaltedeckel**  
matt polished, rotating food, canister removable, including airtight covers  
pulido mate, giratorio, incluye tapas herméticas  
poli mat, rotatif, inclut couvercles hermétiques

	Ø cm	↑ cm	ltr.
11970	38	54	3 x 4,5



### Cerealienspender „ROTATION“

cereal dispenser  
dispensador de cereales  
distributeur de céréales



**Buchenholz versiegelt, drehbarer massiver Ständer, Behälter herausnehmbar, inklusive Frischhaltedeckel**

wood beech covered waterproof, rotating foot, canister removable, incl. airtight cover  
tapa en madera de haya resistente al agua, pie giratorio, recipiente extraíble, incluye tapa hermética  
couvercle en hêtre traitée contre l'humidité, pied rotatif, récipients démontables, inclut couvercles hermétiques

	Ø cm	↑ cm	ltr.
11975	38	54	3 x 4,5



**Cerealienspender „BRIDGE“**

cereal dispenser  
dispensador de cereales  
distributeur de céréales



**Behälter herausnehmbar, „Feierabend-Deckel“ für das aromadichte Lagern, portionieren durch einfaches Drehen**

removable canister, special lid to keep the cereals fresh,  
easy to use, rotate the button to get the muesli  
contenedor extraíble, tapa especial para mantener los cereales frescos,  
fácil de usar, se gira el pomo para servir los cereales  
récipient amovible, couvercle spécial pour conserver les céréales,  
usage facile en tournant le bouton

	cm	↑ cm	ltr.	Farbe / Colour	
13987	21 x 20	55,5	4,5		Ahorn



**Cerealienspender „BRIDGE“**

cereal dispenser  
dispensador de cereales  
distributeur de céréales



**Behälter herausnehmbar, „Feierabend-Deckel“ für das aromadichte Lagern, portionieren durch einfaches Drehen**

removable canister, special lid to keep the cereals fresh,  
easy to use, rotate the button to get the muesli  
contenedor extraíble, tapa especial para mantener los cereales frescos,  
fácil de usar, se gira el pomo para servir los cereales  
récipient amovible, couvercle spécial pour conserver les céréales,  
usage facile en tournant le bouton

	cm	↑ cm	ltr.	Farbe / Colour	
14987	21 x 20	55,5	4,5		Wenge



**Buffetständer „GOOD MORNING“**

buffet stand  
expositor de buffet  
présentoir de buffet



**4-teiliges Set: 1 Holzständer inklusive 3 Gläser mit luftdichtem Klappdeckel**

4 pcs.: 1 wood stand including 3 glasses with airtight cover  
set de 4: 1 soporte con 3 cuencos de cristal con cierre hermético  
set de 4: 1 présentoir avec 3 bols en verre avec fermeture hermétique

	cm	Farbe / Colour	
13965	43 x 17		Ahorn
14965	43 x 17		Wenge

**Glas mit luftdichtem Klappdeckel**

glass with airtight cover  
cristal, cierre hermético  
verre, fermeture hermétique

	cm	↑ cm	ltr.
82328	12 x 12	22	2

## CEREAL DISPENSERS

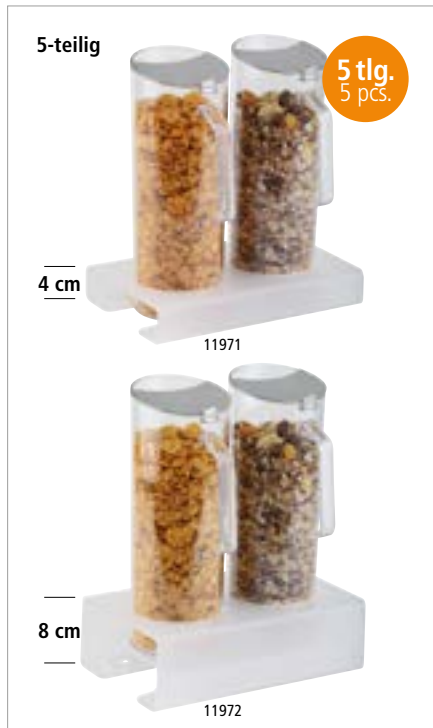

### Cerealien-Bar

cereal-bar

barra para dispensador de cereales

bar à céréales



**5-teiliges Set: mit Ständerhöhe 4 oder 8 cm: 1 Ständer aus Acryl gefrostet und rutschfest + 2 Karaffen mit schwenkbarem Edelstahl-Deckel + 2 luftdichte Frischhaltedeckel**

5 pcs.: with stand heights 4 or 8 cm: 1 stand acryl frosted and non-slip + 2 pitchers with stainless steel flap lid + 2 airtight covers

set de 5: stands a diferentes alturas, 4 u 8 cm: 1 stand acryl + 2 jarras con tapa de solapa de acero inoxidable + 2 tapas herméticas adicionales

set de 5: supports à différentes hauteurs: 4 ou 8 cm - 1 support acrylique satiné antidérapant + 2 pichets à céréales avec couvercle à charnière inox + 2 couvercles hermétiques

	cm	↑ cm	ltr.
11971	26 x 17	28,5	2 x 1,5
11972	26 x 17	32,5	2 x 1,5



ideal für Stufenpräsentation  
best for staged presentations

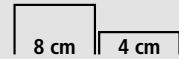

### Cerealien-Bar

cereal-bar

barra para dispensador de cereales

bar à céréales



**7-teiliges Set: mit Ständerhöhe 4 oder 8 cm: 1 Ständer aus Acryl gefrostet und rutschfest + 3 Karaffen mit schwenkbarem Edelstahl-Deckel + 3 luftdichte Frischhaltedeckel**

7 pcs.: with stand heights 4 or 8 cm: 1 stand acryl frosted and non-slip + 3 pitchers with stainless steel flap lid + 3 airtight covers

set de 7: con stands a diferentes alturas, 4 u 8 cm: 1 stand acryl + 3 jarras con tapa de solapa de acero inoxidable + 3 tapas herméticas adicionales

set de 7: supports à différentes hauteurs: 4 ou 8 cm - 1 support acrylique satiné antidérapant + 3 pichets à céréales avec couvercle à charnière inox + 3 couvercles hermétiques

	cm	↑ cm	ltr.
11973	38 x 17	28,5	3 x 1,5
11974	38 x 17	32,5	3 x 1,5



ideal für Stufenpräsentation  
best for staged presentations



### Cerealienkaraffe

cereal pitcher

jarra de cereales

pichet à céréales



**schwenkbarer Edelstahl-Deckel, inklusive luftdichtem Frischhaltedeckel**

stainless steel flap lid, incl. 1 airtight cover

tapa giratoria de acero inoxidable con tapa hermética para mantener los alimentos frescos

couvercle pivotant en acier inox avec couvercle hermétique pour conserver les aliments

	Ø cm	↑ cm	ltr.
10778	10	28	1,5

**Frischhaltedeckel / conservation lid / tapa de conservación / couvercle de conservation**

10668

## CANISTERS



82255 1,0 ltr.



82256 2,0 ltr.



82257 2,5 ltr.

## Vorratsglas „WOODY“

canister with lid  
bote con tapa  
pot en verre avec couvercle

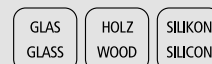

Glasbehälter mit Holzdeckel, aromadichter Verschluss

glass container, aroma-tight screw cap  
recipiente de cristal, tapa con cierre hermético para conservar el aroma  
récipient en verre, couvercle avec fermeture hermétique pour conserver l'arôme

	cm	↑ cm	ltr.
82255	14 x 14	11,0	1,0
82256	14 x 14	17,0	2,0
82257	14 x 14	21,5	2,5



Holzdeckel aus Kiefernholz mit Silikondichtung  
wooden lid from pine wood with silicone gasket



82265 1 ltr.



82266 1,2 ltr.



82267 1,5 ltr.

## Vorratsglas

canister with lid  
bote con tapa  
pot en verre avec couvercle

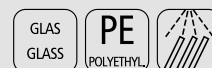

inklusive Glasdeckel mit Dichtung und Beschriftungsfeld, somit bleibt Ihre Ware frisch

including glass lid with seal and labeling field, thus, your goods remain fresh  
con tapa de vidrio con junta y campo de etiquetado, por lo tanto, sus productos permanecen frescos

y compris couvercle en verre avec joint et le domaine de l'étiquetage, ainsi, vos marchandises restent fraîches

	Ø cm	↑ cm	ltr.
82265	11,0	18,0	1,0
82266	11,5	19,5	1,2
82267	12,0	21,0	1,5



71490

Kreidestift zum Beschriften | chalk marker for writing  
S. 304

## CANISTERS



### Vorratsglas „CLASSIC“

canister with lid  
bote con tapa  
pot en verre avec couvercle



**inklusive Glasdeckel mit Dichtung, somit bleibt Ihre Ware frisch**

including glass lid with seal, thus, your goods remain fresh  
con tapa de vidrio con junta, por lo tanto, sus productos permanecen frescos  
y compris couvercle en verre avec joint, ainsi, vos marchandises restent fraîches

	Ø cm	↑ cm	ltr.
82250	11,5	16,0	0,9
82251	14,0	21,5	2,0
82252	18,0	26,0	4,0
82253	20,0	30,0	6,0



### Vorratsglas mit luftdichtem Klappdeckel

glass with airtight cover  
bote con cierre hermético  
pot en verre avec fermeture hermétique



	cm	↑ cm	ltr.
82328	12 x 12	22	2



seitlich gestellt  
placed sideways  
1 ltr.

hochkant gestellt  
placed upright  
2,2 ltr.

### Vorratsglas

canister with lid  
bote con tapa  
pot en verre avec couvercle



**mit Löffel, Schraubdeckel mit aromadichtem Verschluss, Edelstahlöffel mit magnetischem Silikongriff**

tight cover, stainless steel spoon with magnetic silicone handle  
tapa a rosca con cierre hermético, cuchara de acero inoxidable con mango de silicona magnético

couvercle à vis avec fermeture hermétique, cuillère en acier inox avec manche de silicone aimanté

	cm	↑ cm	ltr.
00636	17 x 12,5	18	1 - 2,2



**seitlich gestellt**  
placed sideways  
**1 ltr.**



**hochkant gestellt**  
placed upright  
**2,2 ltr.**

**Vorratsglas**

canister with lid  
bote con tapa  
pot en verre avec couvercle  
**mit Schraubdeckel, aromadichtem Verschluss**  
aroma-tight screw cap  
tapa a rosca para conservar el aroma  
couvercle à vis pour conserver l'arôme



	cm	↑ cm	ltr.
00637	17 x 12,5	18	1 - 2,2

**stapelbar**  
stackable

↑ **Frontklappe**  
front lid



11884

11885

**Universalbox**

box / sweetbox  
caja dispensadora  
boîte distributrice  
**ideal als Verkaufsbox, mit Frontdeckel**  
best to present sweets etc., all-purpose, with front lid  
la perfecta solución para presentar golosinas, universal, con tapa frontal  
la solution idéale pour les friandises et autres, universel, avec couvercle frontal



	cm	↑ cm	Farbe / Colour
11884	23 x 14,5	15	White
11885	23 x 14,5	15	Red

 Sturzform



82239  
**370 ml**

82240  
**580 ml**

**Weck-Gläser mit Deckel, 2er Set**

Weck-glasses with lid, 2 pcs.  
Weck tarros de vidrio con tapa, set de 2  
Weck verrines avec couvercle, set de 2



**2 Gläser + 2 Edelstahl Deckel**  
2 glasses + 2 stainless steel lids  
2 tarros + 2 tapas de acero inoxidable  
2 verrines + 2 couvercles en acier inox

	Ø cm	↑ cm	ltr.	pcs
82239	11	7,5	0,37	2
82240	11	11	0,58	2

 Sturzform



82243  
**370 ml**

82244  
**580 ml**

**Weck-Gläser mit Deckel, 2er Set**

Weck-glasses with lid, 2 pcs.  
Weck tarros de vidrio con tapa, set de 2  
Weck verrines avec couvercle, set de 2



**2 Gläser + 2 Deckel aus Buchenholz**  
2 glasses + 2 beech wood lids  
2 tarros + 2 tapas de madera de haya  
2 verrines + 2 couvercles en bois hêtre

	Ø cm	↑ cm	ltr.	pcs
82243	11	7,5	0,37	2
82244	11	11	0,58	2

**NEW** PERFECTO



**NEW**

**3 tlg.**  
3 pcs.



33300

3-teiliges Set | 3 pcs.



33302

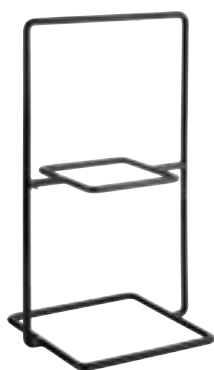

33304



**2-stufige Etagère „PERFECTO SMALL“**

2-tier tray  
bandeja dos alturas  
étagère carré 2 hauteurs

HOLZ  
WOOD

METALL

PVC  
KUNSTSTOFF



3-teiliges Set, bestehend aus:

- 1 Buffetständer, Metall, PVC, schwarz, 23 x 19 cm, H: 40,5 cm
- 2 Bretter aus Eichenholz, geölt, 20 x 20 cm, H: 2 cm

3 pcs., consisting of:

- 1 buffet stand, metal, PVC, black, 23 x 19 cm, h: 40,5 cm
- 2 boards, oiled oak, 20 x 20 cm, h: 2 cm

set de 3, compuesto por:

- 1 soporte buffet, metal, PVC, negro, 23 x 19 cm, a: 40,5 cm
- 2 tablas de roble, aceitadas, 20 x 20 cm, a: 2 cm

set de 3, composé de :

- 1 support de buffet, métal, PVC, noir, 23 x 19 cm, h: 40,5 cm
- 2 planches en bois de chêne, huilées, 20 x 20 cm, h: 2 cm

	cm	↑ cm
33300	20 x 23	40,5

Brett aus Eichenholz / oak board / tabla de roble / planche en chêne

	cm	↑ cm
33302	20 x 20	2

Buffetständer / buffet stand / soporte de buffet / support de buffet

	cm	↑ cm
33304	19 x 23	40,5



Präsentationsmöglichkeit  
presentation example



2-stufige Etagère „PERFECTO LARGE“

2-tier tray  
bandeja dos alturas  
étagère carré 2 hauteurs



4-teiliges Set, bestehend aus:

- 2 Buffetständer, Metall, PVC, schwarz, 23 x 19 cm, H: 40,5 cm
- 2 Bretter aus Eichenholz, geölt, 80 x 20 cm, H: 2 cm

4 pcs., consisting of:

- 2 buffet stands, metal, PVC, black, 23 x 19 cm, h: 40,5 cm
- 2 boards, oiled oak, 80 x 20 cm, h: 2 cm

set de 4, compuesto por:

- 2 soportes buffet, metal, PVC, negro, 23 x 19 cm, a: 40,5 cm
- 2 tablas de roble, aceitadas, 80 x 20 cm, a: 2 cm

set de 4, composé de :

- 2 supports de buffet, métal, PVC, noir, 23 x 19 cm, h: 40,5 cm
- 2 planches en bois de chêne, huilées, 80 x 20 cm, h: 2 cm

	cm	↑ cm
33301	80 x 23	40,5

Brett aus Eichenholz / oak board / tabla de roble / planche en chêne

	Ø cm	↑ cm
33303	80 x 20	2

Buffetständer / buffet stand / soporte de buffet / support de buffet

	cm	↑ cm
33304	19 x 23	40,5



Präsentationsmöglichkeit  
presentation example

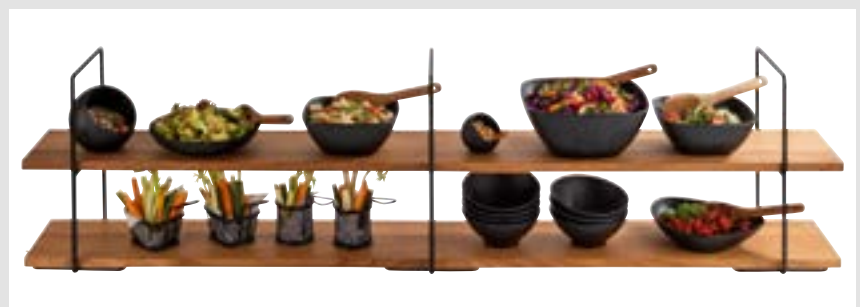

Präsentationsmöglichkeit 3 Buffetständer + 4 Bretter  
presentation example 3 buffet stands / 4 boards



platzsparend  
space saving

# BUFFET STAND

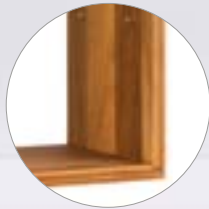

**Eichenholz geölt**  
oak wood oiled

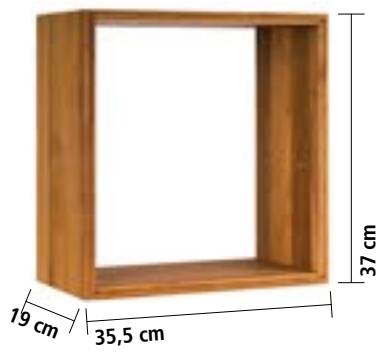

83481  
GN 1/3



83491  
GN 1/3

## Buffetständer „WINDOW“

buffet stand  
soporte para buffet  
présentoir buffet

**Eichenholz geölt**  
oak wood oiled  
madera de roble aceitada  
bois de chêne huilé



	cm	↑ cm	
11740	35,5 x 19	37	inkl. 20 Haltestiften für Einlegeböden / incl. 20 fixing pins for shelves



inklusive 20 Haltestifte  
including 20 fixing pins

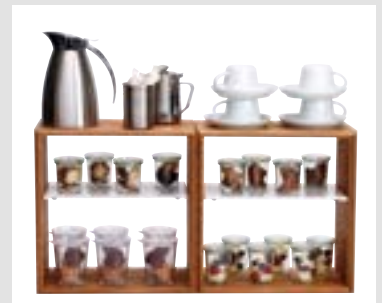

Präsentationsmöglichkeiten  
presentation examples

geeignet für GN 1/3 Tablett / for GN 1/3 trays / para bandejas GN 1/3 / pour plateaux GN 1/3

	cm	↑ cm	Farbe / Colour
84187	32,5 x 17,6	1,5	
83481	32,5 x 17,6	3,0	
83491	32,5 x 17,6	3,0	



NEW

# ACACIA

NEW



00794 1,8 ltr.



00795 2,5 ltr.



00796 3,0 ltr.

## Schale „ACACIA“

bowl  
cuenco  
bol

aus geöltem Akazienholz  
made of oiled acacia wood  
de madera de acacia aceitada  
en bois d'acacia huilé



	Ø cm	↑ cm	ltr.
00794	21	8,5	1,8
00795	25	8,5	2,5
00796	27	8,5	3,0



passender Deckel mit Löffelaussparung / suitable cover with notched for spoons /  
tapa adecuada con espacio para la cuchara / couvercle appropriée avec encoche pour la louche

	Ø cm	↑ cm	fits to
83920	20,5	1,3	00794



3 Größen ineinander  
3 sizes in each other



33269

## Buffetständer „MULTI ROUND“

buffet stand  
soporte para buffet  
présentoir buffet

Metall, mit schwarzer Antirutschbeschichtung  
metal, with black anti-slide coating  
metal, con revestimiento antideslizante negro  
métal, avec revêtement antidérapant noir



	Ø cm	↑ cm
33269	15,5 / 18	8
33270	15,5 / 18	10
33271	15,5 / 18	18

## BUFFET DISPLAY



### Buffet Box „TOAST BOX“

buffet box  
caja de buffet  
boîte de buffet



aus geöltem Eichenholz, Deckel aus Kunstleder, 2 Fächer: 28 x 16,5 cm, H: 16 cm, mit herausnehmbarem Sichtfenster aus Acryl

made of oiled oak wood, lid made of imitation leather, 2 compartments: 28 x 16.5 cm, H: 16 cm, with removable viewing window made from acrylic

de madera de roble aceitada, tapa de polipiel, 2 compartimentos: 28 x 16,5 cm, H: 16 cm, con ventanilla acrílica extraíble

en bois de chêne huilé, couvercle en simili-cuir, 2 compartiments : 28 x 16,5 cm, H : 16 cm, avec fenêtre amovible en acrylique

	cm	↑ cm	Farbe / Colour
11713	36 x 33,5	16	natural oak
11714	36 x 33,5	16	dark oak



Präsentationsmöglichkeit  
presentation example



### Buffet Box „SEWING BASKET“

buffet box  
caja de buffet  
boîte de buffet



aus geöltem Eichenholz, 3 Fächer: 33 x 27 cm, H: 7 cm, passend für GN 1/2

made of oiled oak wood, 3 compartments: 33 x 27 cm, H: 7 cm, suitable for GN 1/2

de madera de roble aceitada, 3 compartimentos: 33 x 27 cm, H: 7 cm, para GN 1/2

en bois de chêne huilé, 3 compartiments: 33 x 27 cm, H: 7 cm, pour GN 1/2

	cm	↑ cm	Farbe / Colour
11711	36 x 29	28	natural oak
11712	36 x 29	28	dark oak



Präsentationsmöglichkeit  
presentation example



**Buffetgestell „TRIANGLE“**

buffet stand  
expositor de buffet  
présentoir buffet



**Ahorn massiv, 3 Ebenen: 1.: 53 x 19 cm, 2.: 40 x 17,5 cm, 3.: 30 x 15 cm**  
solid maple, 3 levels: 1.: 53 x 19 cm, 2.: 40 x 17,5 cm, 3.: 30 x 15 cm  
arce sólido, 3 niveles: 1.: 53 x 19 cm, 2.: 40 x 17,5 cm, 3.: 30 x 15 cm  
érable massif, 3 niveaux: 1.: 53 x 19 cm, 2.: 40 x 17,5 cm, 3.: 30 x 15 cm

	cm	↑ cm	Farbe / Colour	
13966	53 x 21	50		Ahorn / maple

**Buche massiv, 3 Ebenen: 1.: 53 x 19 cm, 2.: 40 x 17,5 cm, 3.: 30 x 15 cm**  
beech maple, 3 levels: 1.: 53 x 19 cm, 2.: 40 x 17,5 cm, 3.: 30 x 15 cm  
haya sólido, 3 niveles: 1.: 53 x 19 cm, 2.: 40 x 17,5 cm, 3.: 30 x 15 cm  
hêtre massif, 3 niveaux: 1.: 53 x 19 cm, 2.: 40 x 17,5 cm, 3.: 30 x 15 cm

	cm	↑ cm	Farbe / Colour	
14966	53 x 21	50		Wenge / wenge



**Buffetgestell „BIRDCAGE“**

buffet stand  
soporte para buffet  
présentoir buffet



**Gestell aus schwarzem Metall, inklusive 2 Akazienholzplatten**  
black metal frame, incl. 2 acacia wood panels  
soporte metálico negro, con 2 tablas de madera de acacia  
support métallique noir, avec 2 panneaux en bois d'acacia

	Ø cm	↑ cm
33206	26	54

**Ersatz-Holzplatte**  
spare wooden panel  
tabla de madera de recambio  
panneau en bois de rechange

	Ø cm	↑ cm
33207	25	1



passende Akazienholzplatte  
fitting acacia wood panels



Gestell mit abgerundeten Füßen  
frame with rounded feet



**NEW**

# FRIENDLY BOWL

- hergestellt aus gebrauchtem Plastik – aus 100% recyceltem Post-Consumer PET (RePET)
- vollständig recycelbar und 100% umweltschonend
- spülmaschinengeeignet bis 55°C
- made from used plastic – made of 100% recycled post-consumer PET (RePET)
- fully recyclable and 100% environmentally friendly
- dishwasher safe up to 55°C
- fabricado de plástico usada: 100% de PET reciclado postconsumo (RePET)
- totalmente reciclable y 100% ecológico
- apto para lavavajillas hasta 55°C
- fabriqué de plastique usagée – composé à 100% de PET recyclé post-consumation (RePET)
- entièrement recyclable et 100% écologique
- lavable au lave-vaisselle jusqu'à 55°C

Safe the Planet:  
Gebrauchtes Plastik  
+ Zerkleinern + Reinigen  
+ Schmelzen und Spritzen  
= NEUES LEBEN

Safe the Planet:  
used plastic  
+ crushing + cleaning  
+ melting and spraying  
= NEW LIFE

Safe the Planet:  
plástico usado  
+ trituración + limpieza  
+ fusión y pulverización  
= NUEVA VIDA

Safe the Planet :  
plastique usagée  
+ broyage + nettoyage  
+ fonte et injection  
= NOUVELLE VIE



## Schale „FRIENDLY BOWL“ bowl cuenco bol



**friendly bowl**

vollständig recycelbar und 100% umweltschonend  
fully recyclable and 100% environmentally friendly  
totalmente reciclable y 100% ecológico  
entièrement recyclable et 100% écologique

	cm	↑ cm	ltr.	Farbe / Colour
79000	9,0 x 9,0	4,0	0,14	■
79001	9,0 x 9,0	4,0	0,14	■
79002	12,5 x 12,5	6,5	0,40	■
79003	12,5 x 12,5	6,5	0,40	■
79004	19,0 x 19,0	9,0	1,50	■
79005	19,0 x 19,0	9,0	1,50	■



## Tablett „FRIENDLY TRAY“ tray bandeja plateau



**friendly tray**

vollständig recycelbar und 100% umweltschonend  
fully recyclable and 100% environmentally friendly  
totalmente reciclable y 100% respetuoso con el medio ambiente  
entièrement recyclable et 100% écologique

	cm	↑ cm	GN	Farbe / Colour
79006	32,5 x 26,5	3	1/2	■
79007	32,5 x 26,5	3	1/2	■





**Dressingtopf-Display / -Station**  
 wooden station for 3 dressing pots  
 expositor de madera para 3 salseras  
 présentoir en bois pour 3 pots à sauce  
**inklusive 3 Beschriftungsschilder aus Metall**  
 including 3 metal labels  
 con 3 etiquetas de metal  
 avec 3 étiquettes métalliques



	cm	↑ cm
84863	40 x 16	9



passend für 83311, 83867, 30060  
 suitable for 83311, 83867, 30060



**Dressingtopf „PASTELL“**  
 dressing pot  
 salsera  
 pot à sauce



	cm	↑ cm	ltr.	Farbe / Colour
84862	13	19,5	1,5	Green
84860	13	19,5	1,5	White
84861	13	19,5	1,5	Pink

**Beschriftungsetiketten, 72 Stück / labeling labels, 72 pcs. / etiquetas, 72 pzs / étiquettes, 72 pcs.**

	cm	Farbe / Colour
00069	8 x 4,6	Black



mit Antirutschfüßchen  
 with non-slip feet



stapelbar  
 stackable



**Dressingtopf „CASUAL“**  
 dressing pot  
 salsera  
 pot à sauce



	cm	↑ cm	ltr.	Farbe / Colour
83867	12	21,5	1	White
83868	12	21,5	1	Black



**Dressingtopf**  
 dressing pot  
 salsera  
 pot à sauce



**Deckel mit Löffelaussparung**  
 cover notched for spoon  
 tapa agujereada para el cucharón  
 couvercle avec espace pour la louche

	Ø cm	↑ cm	ltr.
83310	17,0	15	2,0
83311	13,0	13	0,8

## BUFFET DISPLAY



### Schale „ELEMENT“

bowl  
cuenco  
bol



	Ø cm	↑ cm	ltr.
30000	22	6,0 / 10,5	1,1
30001	26	7,5 / 13,0	1,7
30002	29,5	8,5 / 14,5	2,5



möbelschonende Unterseite  
furniture-friendly underside



Präsentationsmöglichkeiten  
presentation example



### Schale „COCONUT“

bowl  
cuenco  
bol



	Ø cm	↑ cm	ltr.
30020	18	9,5	1
30021	23	12,5	2,2



möbelschonende Unterseite  
furniture-friendly underside



### Buffetständer

buffet stand  
expositor de buffet  
présentoir buffet



**Akazienholz**  
acacia wood  
madera de acacia  
bois d'acacia

	Ø cm	↑ cm
33255	15	10
33256	25	15

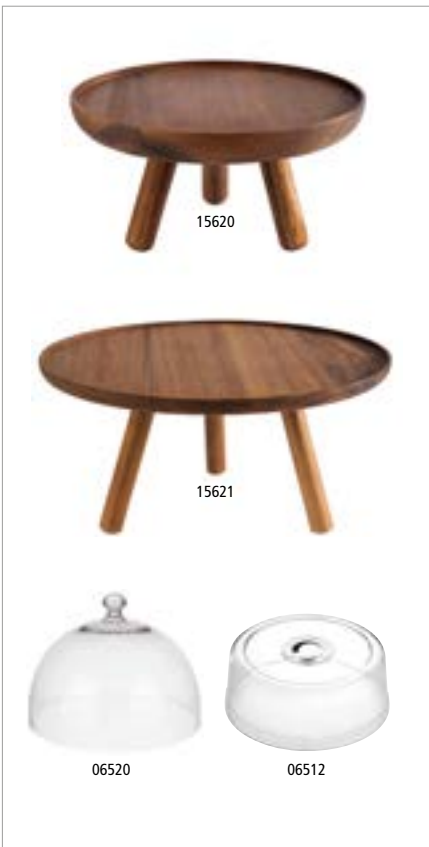
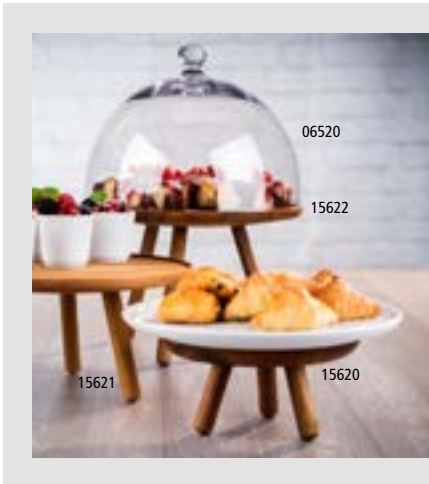

**Buffetständer „ACACIA“**

buffet stand  
soporte para buffet  
présentoir buffet

Akazienholz geölt / acacia wood oiled / madera de acacia aceitada / bois d'acacia huilé



	Ø cm	↑ cm
15620	20,0	10,5
15621	30,5	15,0
15622	30,5	20,0

**Frischhaltehaube / cover / campana / cloche**



	Ø cm	↑ cm	fits to
06520	30	22	15621, 15622

**Frischhaltehaube / cover / campana / cloche**



	Ø cm	↑ cm	fits to
06512	30	11,5	15621, 15622



**Buffetständer „ACACIA“**

buffet stand  
soporte para buffet  
présentoir buffet

Akazienholz geölt / acacia wood oiled / madera de acacia aceitada / bois d'acacia huilé



	cm	↑ cm	GN
15623	53 x 16,2	20	2/4

**GN Abdeckhaube / GN cover / GN campana/ GN cloche**



	cm	↑ cm	GN
11044	53 x 16,2	10,5	2/4

## BUFFET DISPLAY



inklusive Induktionskochplatte 900 Watt

Die Induktionsstation mit Regler präsentiert sich in einem Set aus Walnussholz, einem schwarzen Metallständer und einer Induktionsheizung.

The induction station with controller is presented in a set of walnut wood, a black metal stand and an induction heater.

La estación de inducción con regulador se presenta en un set formado por una caja de madera de nogal, un soporte de metal negro y un calentador de inducción.

La station à induction avec température réglable se compose d'un caisson en bois noyer, d'un support métallique noir et d'une plaque à induction.



### Induktionsstation, 4-teiliges Set

induction station, 4 pcs.  
estación de inducción, set de 4  
station d'induction, set de 4

4 teiliges Set:

- 1 Induktionskochplatte mit Regler (Ø 24 cm, 900 Watt)
- 1 Metallständer schwarz
- 1 Rahmen aus Walnussholz geölt
- 1 Edelstahlrahmen

4 pcs. set:

- 1 induction hotplate with controller (Ø 24 cm, 900 Watt)
- 1 metal stand black
- 1 frame in oiled walnut wood
- 1 stainless steel frame

set de 4:

- 1 placa de inducción con regulador (Ø 24 cm, 900 vatios)
- 1 soporte de metal negro
- 1 caja de madera de nogal aceitada
- 1 marco de acero inoxidable

set de 4:

- 1 plaque d'induction avec température réglable (Ø 24 cm, 900 watts)
- 1 support métallique noir
- 1 caisson en bois noyer huilé
- 1 cadre en acier inox

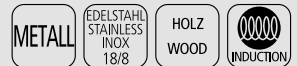

	cm	↑ cm
12270	35,4 x 32,5	19

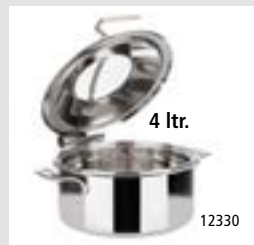

4 ltr.

12330

passendes Chafing Dish Set 12330  
suitable chafing dish set 12330

### Ersatzteile / replacement parts / piezas de repuesto / pièces de rechange

	cm	↑ cm	
12271	35,4 x 32,5	8,5	Holzrahmen / wooden frame
12272	29,5 x 26,5	1	Edelstahlrahmen / stainless steel frame
12295	Ø 24	-	900 Watt Induktionskochplatte / induction plate
15506	35,4 x 32,5	17,6	Buffetständer schwarz / buffet stand black



**Buffetleiter „BIG“**

buffet ladder  
dispensador en escalera  
présentoir buffet en escalier



**12-teiliges Set: 4 Glasschalen Ø 23 cm 2,5 Liter, 4 klappbare Schutzdeckel mit Beschriftungsfenster, 1 Leiter, 1 Doppelring, 2 Einzelringe, einfach und individuell zusammensetzbar**

12 pcs. set: 4 glass bowls Ø 23 cm 2.5 litres, 4 hinged covers with card for inscription, 1 ladder, 1 double ring, 2 single rings, easy to fix and individual to use  
set de 12: 4 cuencos de vidrio Ø 23 cm 2,5 l, 4 tapas abatibles con ventana para etiqueta, 1 soporte escalera, 1 aro doble, 2 aros sencillos, fácil de montar, posible usar individualmente  
set de 12: 4 bols en verre Ø 23 cm 2,5 l, 4 couvercles à charnière et fenêtre pour étiquette, 1 support escalier, 1 cercle double, 2 cercles simples, montage facile, utilisable individuellement

	cm	↑ cm
11598	39 x 31	66



**Buffetleiter „BIG“**

buffet ladder  
dispensador en escalera  
présentoir buffet en escalier



**11-teiliges Set: 6 Glasschalen Ø 23 cm 2,5 Liter, 1 Leiter, 2 Doppelringe, 2 Einzelringe, einfach und individuell zusammensetzbar**

11 pcs. set: 6 glass bowls Ø 23 cm 2.5 litres, 1 ladder, 2 double rings, 2 single rings, easy and individual to use  
set de 11: 6 cuencos de vidrio Ø 23 cm 2,5 l, 1 soporte escalera, 2 aros dobles, 2 aros sencillos, fácil montar, se puede usar individualmente  
set de 11: 6 bols en verre Ø 23 cm 2,5 l, 1 support escalier, 2 cercles doubles, 2 cercles simples, montage facile, utilisable individuellement

	cm	↑ cm
11599	39 x 31	66

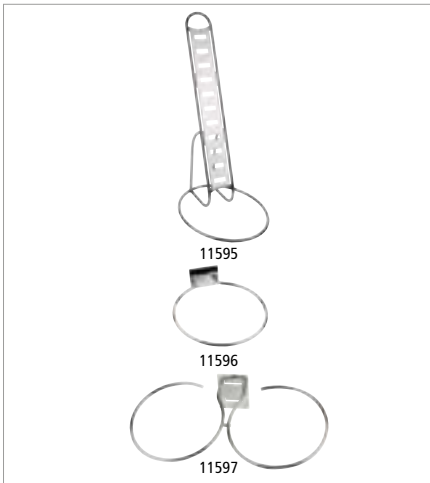

**Einzelteile / spare parts / piezas de recambio / pièces détachées**

**Leitergestell / frame / marco solo / échelle support**

	cm	↑ cm
11595	39 x 31	66

**Einzelring / single ring / aro sencillo / cercle simple**

	Ø cm
11596	23,5

**Doppelring / double ring / aro doble / cercle double**

	cm
11597	48 x 23,5



**Schale**

bowl  
cuenco  
bol



	Ø cm	↑ cm	ltr.
11875	23	10,5	2,5



**Schutzdeckel mit Löffelaussparung**

cover  
tapa  
couvercle



	Ø cm
11878	23,5

## BUFFET DISPLAY



### Buffetleiter „LITTLE“

buffet ladder  
dispensador en escalera  
présentoir buffet en escalier



12-teiliges Set: 4 Glasschalen Ø 14 cm 0,5 Liter, 4 klappbare Schutzdeckel mit Beschriftungsfenster, 1 Leiter, 1 Doppelring, 2 Einzelringe, einfach und individuell zusammensetzbar

12 pcs. set: 4 glass bowls Ø 14 cm 0.5 litres, 4 hinged covers with card for inscription, 1 ladder, 1 double ring, 2 single rings, easy and individual to use  
set de 12: 4 cuencos de vidrio Ø 14 cm 0,5 l, 4 tapas abatibles con ventana para etiqueta, 1 soporte escalera, 1 aro doble, 2 aros sencillos, fácil montaje, se puede usar individualmente  
set de 12: 4 bols en verre Ø 14 cm 0,5 l, 4 couvercles à charnière et fenêtre pour étiquette, 1 support escalier, 1 cercle double, 2 cercles simples, montage facile, utilisable individuellement

	cm	↑ cm
11498	30 x 30	48



### Buffetleiter „LITTLE“

buffet ladder  
dispensador en escalera  
présentoir buffet en escalier



11-teiliges Set: 6 Glasschalen Ø 14 cm 0,5 Liter, 1 Leiter, 2 Doppelringe, 2 Einzelringe, einfach und individuell zusammensetzbar

11 pcs. set: 6 glass bowls Ø 14 cm 0.5 litres, 1 ladder, 2 double rings, 2 single rings, easy and individual to use  
set de 11: 6 cuencos de vidrio Ø 14 cm 0,5 l, 1 soporte escalera, 2 aros dobles, 2 aros sencillos, fácil montaje, se puede usar individualmente  
set de 11: 6 bols en verre Ø 14 cm 0,5 l, 1 support escalier, 1 cercles doubles, 2 cercles simples, montage facile, utilisable individuellement

	cm	↑ cm
11499	30 x 30	48

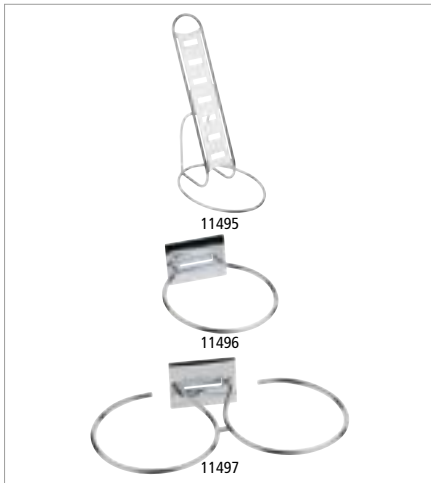

Einzelteile / spare parts / piezas de recambio / pièces détachées

Leitergestell / frame / marco solo / échelle support

	Ø cm	↑ cm
11495	30	48

Einzelring / single ring / aro sencillo / cercle simple

	Ø cm
11496	14

Doppelring / double ring / aro sencillo / cercle double

	cm	cm
11497	29,5 x 14,5	48



### Schale

bowl  
cuenco  
bol



	Ø cm	↑ cm	ltr.	VE / unit
11865	14	6,5	0,5	6



### Schutzdeckel mit Löffelaussparung

cover  
tapa  
couvercle



	Ø cm
11868	14,5



7 tlg.  
7 pcs.

**Buffetgestell „SUNDAY“**

buffet stand  
expositor buffet  
présentoir buffet



7-teiliges Set: 3 Glasschalen Ø 23 cm (2,5 Liter), 3 klappbare Schutzdeckel, 1 Gestell

7 pcs. set: 3 glass bowls Ø 23 cm (2,5 litres), 3 hinged covers, 1 stand  
set de 7: 3 cuencos de cristal Ø 23 cm (2,5 l), 3 tapas con bisagra, 1 soporte  
set de 7: 3 bols en verre Ø 23 cm (2,5 l), 3 couvercles à charnière, 1 support

	cm	↑ cm	
11795	61 x 24	35	

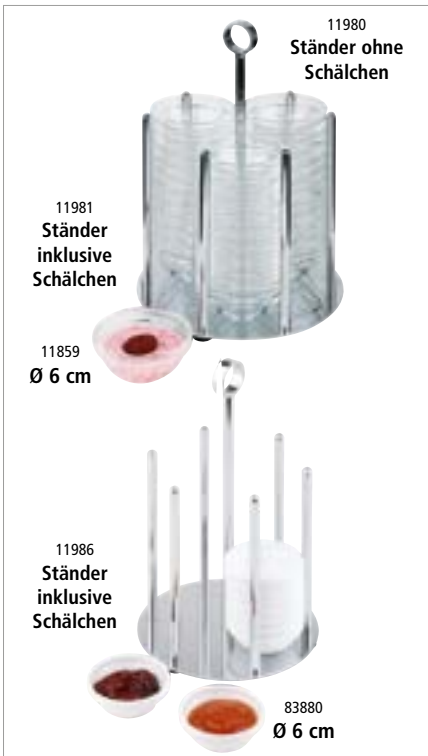

11980  
Ständer ohne  
Schälchen

11981  
Ständer  
inklusive  
Schälchen

11859  
Ø 6 cm

11986  
Ständer  
inklusive  
Schälchen

83880  
Ø 6 cm

**Schälchenspender „MINI“**

bowl holder  
rack dispensador para cuencos  
porte-bols



geeignet für Schalen Ø 6 cm, bestückbar mit bis zu 36 Schalen

for bowls Ø 6 cm, suitable for 36 bowls  
para cuencos de Ø 6 cm, apto para 36 cuencos  
pour bols de Ø 6 cm, pour 36 bols

	Ø cm	↑ cm	
11981	14	25,5	Ständer inklusive 36 Glasschalen, Ø 6 cm frame with 36 bowls, Ø 6 cm
11986	14	25,5	Ständer inklusive 36 Melaminschalen, Ø 6 cm frame with 36 melamine bowls, Ø 6 cm

**Schälchenspender „MINI“ / bowl holder / rack dispensador para cuencos / porte-bols**

	Ø cm	↑ cm	
11980	14	25,5	Ständer ohne Schalen / frame without bowls soporte sin cuencos / support sans bols



**Serviergestell „WECK“**

serving stand  
expositor  
présentoir



ohne Gläser  
without glasses  
sin tarros  
sans verrines

	Ø cm	↑ cm	
33246	22	59	12 x Ø 6 cm

**passende Gläser / matching glasses / tarros adecuados / verrines appropriées**

	Ø cm	↑ cm	ltr.	pcs
82310	6	5,5	0,08	12
82312	6	7,0	0,14	12
82314	6	8,0	0,16	12

# BUFFET LADDER GN



## Buffetleiter „LITTLE GN 1/3“

buffet ladder  
dispensador en escalera  
présentoir buffet en escalier

4-teilig: 1 Leiter-Gestell, 3 GN 1/3 Rahmen

4 pcs.: 1 ladder, 3 single rings GN 1/3

set de 4: 1 soporte escalera, 3 aros sencillos GN 1/3

set de 4: 1 support escalier, 3 cercles simples GN 1/3



	cm	↑ cm	fits to
11526	31,5 x 32	48	baskets / pans GN 1/3



## Buffetleiter „LITTLE GN 1/2“

buffet ladder  
dispensador en escalera  
présentoir buffet en escalier

4-teilig: 1 Leiter-Gestell, 3 GN 1/3 Rahmen

4 pcs.: 1 ladder, 3 single rings GN 1/3

set de 4: 1 soporte escalera, 3 aros sencillos GN 1/3

set de 4: 1 support escalier, 3 cercles simples GN 1/3



	cm	↑ cm	fits to
11527	31,5 x 41,5	48	baskets / pans GN 1/2

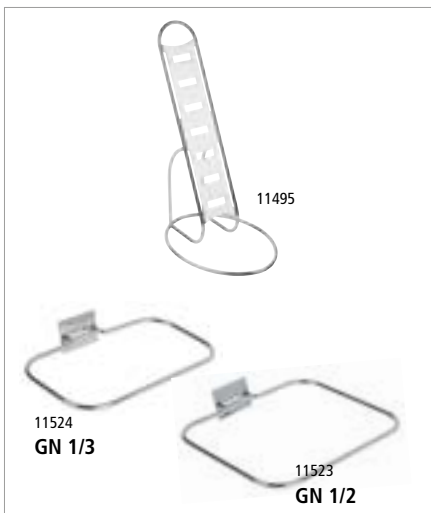

Einzelteile / spare parts / piezas sueltas / pièces détachées

Leitergestell / frame / marco de escalera / échelle support

11495

Einzelring GN 1/3 / single ring GN 1/3 / aro sencillo GN 1/3 / cercle simple GN 1/3

11524

Einzelring GN 1/2 / single ring GN 1/2 / aro sencillo GN 1/2 / cercle simple GN 1/2

11523





2x 84304  
**GN 1/4**

1x 83757  
**GN 1/2**

1x 83757  
**GN 1/2**

1x 83757  
**GN 1/2**

**4 tlg.**  
4 pcs.

**Buffetleiter „BIG GN 1/2“**  
buffet ladder  
dispensador en escalera  
présentoir buffet en escalier

**5-teilig: 1 Leiter-Gestell, 4 GN 1/2 Rahmen**  
5 pcs.: 1 ladder, 4 single rings GN 1/2  
set de 5: 1 soporte escalera, 4 aros sencillos GN 1/2  
set de 5: 1 support escalier, 4 cercles simples GN 1/2

	cm	↑ cm	fits to
11528	31,5 x 56	66	baskets / pans GN 1/2

**METALL**  
VERCHROMT

3x 83753  
**GN 1/3**

2x 83757  
**GN 1/2**

1x 83759  
**GN 1/1**

**4 tlg.**  
4 pcs.

**Buffetleiter „BIG GN 1/1“**  
buffet ladder  
dispensador en escalera  
présentoir buffet en escalier

**4-teilig: 1 Leiter-Gestell, 3 GN 1/1 Rahmen**  
4 pcs.: 1 ladder, 3 single rings GN 1/1  
set de 4: 1 soporte escalera, 3 aros sencillos GN 1/1  
set de 4: 1 support escalier, 3 cercles simples GN 1/1

	cm	↑ cm	fits to
11529	52 x 59	66	baskets / pans GN 1/1

**METALL**  
VERCHROMT

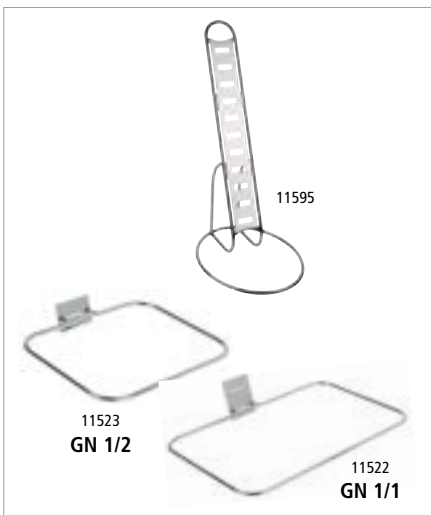

**Einzelteile / spare parts / piezas sueltas / pièces détachées**

**Leitergestell / frame / marco de escalera / échelle support**

11595

**Einzelring GN 1/2 / single ring GN 1/2 / aro sencillo GN 1/2 / cercle simple GN 1/2**

11523

**Einzelring GN 1/1 / single ring GN 1/1 / aro sencillo GN 1/1 / cercle simple GN 1/1**

11522

# ETAGERES

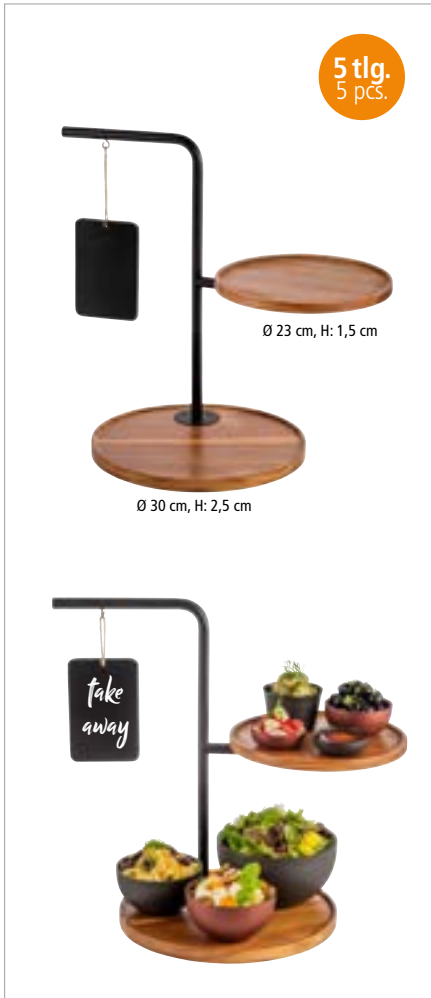

## 2-stufige Etagère „IRON“

2-tier tray  
bandeja con dos alturas  
étagère carré 2 hauteurs

- 1 Gestell aus schwarzem Metall
- 2 Akazienholzplatten: Ø 23 cm, H: 1,5 cm / Ø 30 cm, H: 2,5 cm
- 2 Beschriftungsschilder 15 x 10,5 cm

- 1 soporte metálico negro
- 2 tablas de madera de acacia: Ø 23 cm, H: 1,5 cm / Ø 30 cm, H: 2,5 cm
- 2 etiquetas de inscripción 15 x 10,5 cm

- 1 support métallique noir
- 2 panneaux en bois d'acacia: Ø 23 cm, H: 1,5 cm / Ø 30 cm, H: 2,5 cm
- 2 étiquettes d'inscription 15 x 10,5 cm



	cm	↑ cm
30334	47 x 30	44

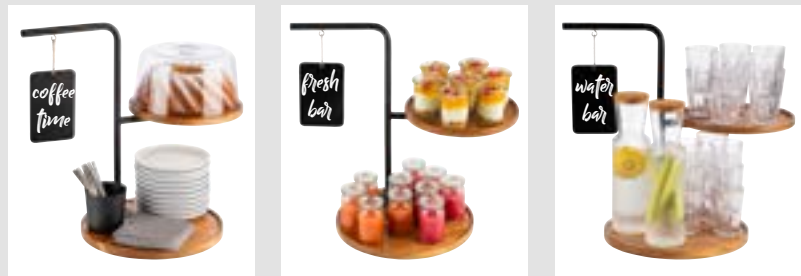

Präsentationsmöglichkeiten  
presentation examples



## 2-stufige Etagère

2-tier tray  
soporte 2 alturas  
étagère 2 niveaux

- 1 Gestell aus Metall schwarz, mit Antirutschfüßchen,
- 2 herausnehmbare Bretter aus geöltem Akazienholz (34,5 x 20,5 x 1,5 cm) / (34,5 x 13 x 1,5 cm)
- 8 Beschriftungsschilder (8 x 4 cm)

- 1 frame made of black metal with non-slip feet,
- 2 removable trays made of acacia wood (34,5 x 20,5 x 1,5 cm) / (34,5 x 13 x 1,5 cm)
- 8 labelling plates (8 x 4 cm)

- 1 soporte metálico, negro con pies antideslizantes,
- 2 bandejas extraíbles de madera de acacia (34,5 x 20,5 x 1,5 cm) / (34,5 x 13 x 1,5 cm)
- 8 etiquetas (8 x 4 cm)

- 1 support métallique noir avec pieds antidérapants,
- 2 planches amovibles en bois d'acacia (34,5 x 20,5 x 1,5 cm) / (34,5 x 13 x 1,5 cm)
- 8 étiquettes (8 x 4 cm)



	cm	↑ cm
30339	35,5 x 21	40

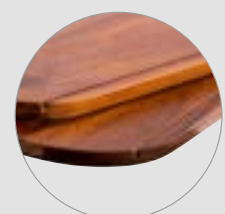

Präsentationsmöglichkeiten  
presentation examples

mit Antirutschfüßchen  
with non-slip feet

geöltes Akazienholz  
oiled acacia wood



1 x Gestell / 1 x frame



2 x Korb / 2 x basket

5 tlg.  
5 pcs.



2 x Tablett / 2 x tray



Haube / cover 11056



Korb / basket 30337



NEW

Tablett / tray 85099



Tablett / tray 30338

## 2-stufige Etagère „ALL-ROUNDER“, 5-teilig

2-tier tray, 5 pcs.

soporte 2 alturas, set de 5

étagère 2 niveaux, set de 5

5 teiliges Set:

- 1 Gestell aus Metall schwarz, mit Antirutschfüßchen,
- 2 Körbe aus Metall schwarz je 29 x 16 cm, H: 7 cm,
- 2 herausnehmbare Bretter aus geöltem Akazienholz je 28,5 x 15,5 cm, H: 1,5 cm

5 pcs.:

- 1 frame made of black metal with non-slip feet,
- 2 removable baskets of black metal each 29 x 16 cm, H: 7 cm,
- 2 boards of oiled acacia wood each 28,5 x 15,5 cm, H: 1,5 cm

set de 5:

- 1 soporte metálico, negro con pies antideslizantes,
- 2 cestas metálicas negras, cada una de 29 x 16 cm, H: 7 cm,
- 2 tablas de madera de acacia aceiteada 28,5 x 15,5 cm, H: 1,5 cm

set de 5:

- 1 support métallique noir avec pieds antidérapants,
- 2 paniers métalliques noirs, chacune 29 x 16 cm, H: 7 cm,
- 2 planches d'acacia huilé, chacune 28,5 x 15,5 cm, H: 1,5 cm



	cm	↑ cm
30336	31 x 17	37,5



multifunktional,  
ideal als

- Frühstücks-Etagère
- Vorspeisen-Etagère
- Kuchen-Etagère
- Brot-Etagère
- Gebäck-Etagère
- Früchte-Etagère

Präsentationsmöglichkeiten  
presentation examples

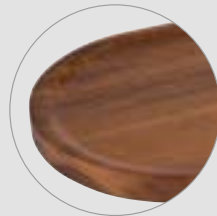

geöltes Akazienholz  
oiled acacia wood



mit Antirutschfüßchen  
with non-slip feet

Korb / basket / cesta / corbeille

	cm	↑ cm	Farbe / Colour
30337	29 x 16	7	■

Servierbrett aus Akazienholz / serving board of acacia wood / tabla de serv de madera de acacia / planche de service en bois d'acacia

	cm	↑ cm	Farbe / Colour
30338	28,5 x 15,5	3,5	■

Melamintablett / melamine tray / bandeja de melamina / plateau en mélamine

	cm	↑ cm	Farbe / Colour
85099 <small>NEW</small>	28,0 x 15,5	1,0	■

Haube / cover / campana / cloche

	cm	↑ cm
11056	26,0 x 12,0	10,0

## ETAGERES



### Serviergestell, 2-stufig

serving stand, 2-tier  
soporte platos, 2 alturas  
présentoir, 2 hauteurs

3 tlg. Set: 1 Gestell aus Akazienholz, 2 Schieferplatten, zusammenklappbar

3 pcs.: 1 stand acacia wood, 2 slate trays, foldable

set de 3: 1 soporte madera de acacia, 2 bandejas de pizarra, plegable

set de 3: 1 présentoir en bois d'acacia, 2 plateaux en ardoise naturelle, pliable



zusammenklappbar  
foldable

	cm	↑ cm
00958	36,5	34 x 26,5



### High Tea Rack

High Tea Rack  
rack de té alto  
étagère à thé avec anse supérieure

Rubberwood dunkelbraun, Edelstahlgriff, 4 große Fächer 15 x 10 x 10 cm, 3 kleine Fächer 9,5 x 9,5 x 10 cm

rubber wood in dark brown, stainless handle, 4 big compartments 15 x 10 x 10 cm, 3 small compartments 9,5 x 9,5 x 10 cm

madera marrón oscura, mango de acero inoxidable, 4 compartimentos grandes 15 x 10 x 10 cm, 3 compartimentos pequeños 9,5 x 9,5 x 10 cm

bois marron foncé, poignée en acier inox, 4 compartiments grands 15 x 10 x 10 cm, 3 compartiments petits 9,5 x 9,5 x 10 cm



	cm	↑ cm
33210	34 x 10	38



### Brezel- oder Wurstständer

pretzel-/ sausage stand  
soporte para pretzels/ embutidos  
support à bretzel ou à saucissons

Verkaufsständer Buchenholz versiegelt, bestens geeignet für die Präsentation von Brezeln, Würstchen, etc., Fuß Ø 22 cm

beech wood, ideal to present pretzels, sausages, etc., , base Ø 22 cm

soporte de madera de haya, ideal para presentar pretzels, salchicas, etc., base Ø 22 cm

support en bois de hêtre, pour la présentation de bretzels, saucisses, etc. pied Ø 22 cm



	Ø cm	↑ cm
79553	28	50

Hygieneschutz für Brezelständer / hygienic cover / campana higiénica antialiento / pare-haleine

	cm	↑ cm
11557	20 x 20 x 20	50
11558	15 x 20 x 15	50



### Hobel für Käse und Schokolade

cheese / choco curler  
rizador para queso y chocolate  
frisette pour fromage et chocolat

3-teilig: Platte Buchenholz versiegelt Ø 22 cm mit senkrechtem Stift

+ Hobel 7 cm + Haube Ø 15 x 10 cm, für Käse und Schokolade

3 pcs.: wooden base Ø 22 cm with vertical bolt + plough 7 cm  
+ cover Ø 15 x 10 cm, for cheese and chocolate

set de 3: base de madera Ø 22 cm, con eje vertical de 7 cm

+ campana Ø 15 x 10 cm, para „rizar“ queso y chocolate

set de 3: base bois Ø 22 cm, axe vertical ht. 7 cm, cloche Ø 15 x ht 10 cm,

pour „friser“ le fromage ou le chocolat



	Ø cm	↑ cm
50002	22	15

inklusive Haube  
including cover

# SERVING STANDS



## 2-stufige Etagère

2-tier étagère  
cesta doble 2 alturas  
étagère 2 paniers

Griff aus Holz, Körbe aus Metall schwarz,  
oberer Korb (Ø 22 cm, H: 6 cm), unterer Korb (Ø 26 cm, H: 8 cm)

wooden handle, baskets made of metal black,  
upper basket (Ø 22 cm, H: 6 cm), lower basket (Ø 26 cm, H: 8 cm)

asa de madera, cestas de metal negro,  
cesta superior (Ø 22 cm, H: 6 cm), cesta inferior (Ø 26 cm, H: 8 cm)

manche en bois, corbeilles en métal noir,  
corbeille supérieure (Ø 22 cm, H: 6 cm), corbeille inférieure (Ø 26 cm, H: 8 cm)



	Ø cm	↑ cm
30335	26	48



Präsentationsmöglichkeiten  
presentation examples

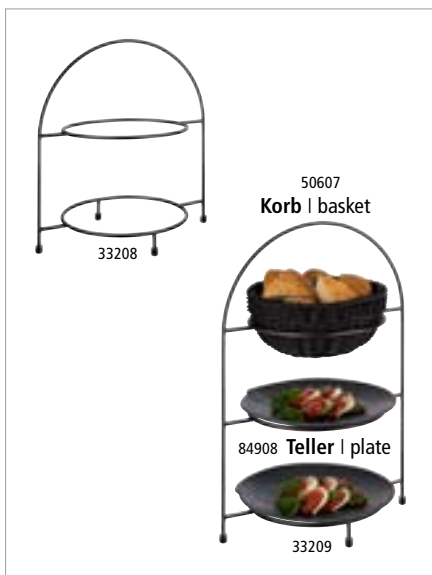

## Serviergestell „INDUSTRIAL“

servicing stand  
soporte platos  
présentoir à assiettes

für Teller max. Ø 27 cm, innerer Ring Ø 18 cm, Lieferung ohne Teller

for plates max. Ø 27 cm, circle inside Ø 18 cm, delivery without dishes

para platos máx. Ø 27 cm, aro interior Ø 18 cm, se entrega sin platos

pour assiettes Ø 27 cm maxi., anneau intérieur Ø 18 cm, livré sans assiettes



	cm	↑ cm	passend für Tellerabdeckhauben / suitable for plate covers
33208	29 x 19,5	30	2 Teller Ø 27 cm innerer Ring Ø 18 cm
33209	29 x 19,5	43	3 Teller Ø 27 cm innerer Ring Ø 18 cm



**Serviergestell**

serving stand  
soporte platos  
présentoir à assiettes



**für 3 Teller max. Ø 27 cm, innerer Ring Ø 18 cm**  
for 3 plates max. Ø 27 cm, circle inside Ø 18 cm  
para 3 platos Ø 27 cm, aro interior Ø 18 cm  
pour 3 assiettes maxi Ø 27 cm, anneau intérieur Ø 18 cm

	cm	↑ cm
33217	33 x 24	43

**für 2 Teller max. Ø 27 cm, innerer Ring Ø 18 cm, Lieferung ohne Teller**  
for 2 plates max. Ø 27 cm, circle inside Ø 18 cm, without dishes  
para 2 platos Ø 27 cm, aro interior Ø 18 cm, se entrega sin platos  
pour 2 assiettes maxi Ø 27 cm, anneau intérieur Ø 18 cm, livré sans assiettes

	cm	↑ cm
33214	33 x 23,5	30

**für 3 Teller max. Ø 17 cm, innerer Ring Ø 10,5 cm**  
for 3 plates max. Ø 17 cm, circle inside Ø 10,5 cm  
para 3 platos Ø 17 cm, aro interior Ø 10,5 cm  
pour 3 assiettes maxi Ø 17 cm, anneau intérieur Ø 10,5 cm

	cm	↑ cm
33216	22,5 x 16,5	25,5



**Serviergestell**

serving stand  
soporte platos  
présentoir à assiettes



**für 3 Teller max. Ø 17 cm, innerer Ring Ø 10,5 cm**  
for 3 plates max. Ø 17 cm, circle inside Ø 10,5 cm  
para 3 platos Ø 17 cm, aro interior Ø 10,5 cm  
pour 3 assiettes maxi Ø 17 cm, anneau intérieur Ø 10,5 cm

	cm	↑ cm	Farbe / Colour
33215	18,5 x 15,5	26	chrome
33211	18,5 x 15,5	26	copper

**für 3 Teller max. Ø 27 cm, innerer Ring Ø 18 cm**  
for 3 plates max. Ø 27 cm, circle inside Ø 18 cm  
para 3 platos Ø 27 cm, aro interior Ø 18 cm  
pour 3 assiettes maxi Ø 27 cm, anneau intérieur Ø 18 cm

	cm	↑ cm	Farbe / Colour
33220	29 x 19,5	43	chrome
33212	29 x 19,5	43	copper



**Serviergestell**

serving stand  
soporte platos  
présentoir à assiettes



**für 2 Teller max. Ø 27 cm, innerer Ring Ø 18 cm**  
for 2 plates max. Ø 27 cm, circle inside Ø 18 cm  
para 2 platos Ø 27 cm, aro interior Ø 18 cm  
pour 2 assiettes maxi Ø 27 cm, anneau intérieur Ø 18 cm

	cm	↑ cm	Farbe / Colour
33219	29 x 19,5	30	chrome



**Etagère „FINESSE“**

etagère  
frutero  
étagère



vergoldeter Messing-Kugelgriff, einfache Montage

gold plated knob, easy to assemble

botón dorado, fácil de montar

bouton doré, montage facile

	Ø cm	↑ cm	
33248	48 / 38 / 32	50	3-stufig / 3-tier 3 alturas / 3 niveaux
33238	38 / 32	30	2-stufig / 2-tier 2 alturas / 2 niveaux

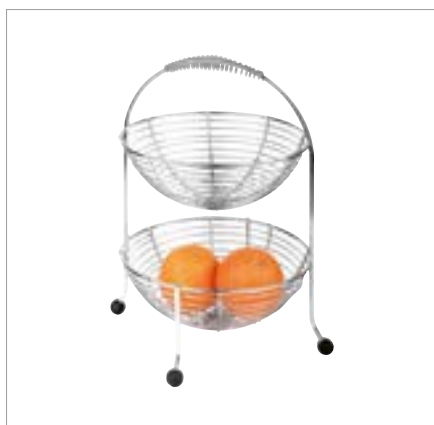

**Etagère**

etagère  
frutero  
corbeille à fruits



ergonomischer Griff, stehend auf schwarzen Antirutsch-Füßen

ergonomic handle, with non-slip feet

asa ergonómica, con pies antideslizantes color negro

anse ergonomique, avec pieds antidérapants noirs

	cm	↑ cm
30325	30 x 30	35,5



**3-stufige Etagère**

3-tier tray  
bandeja con tres alturas  
étagère carré 3 hauteurs



Naturschieferplatte, Akazienholz

natural slate tray, wood akazie

bandeja de pizarra natural, madera de acacia

plateau ardoise naturelle, bois d'acacia

	Ø cm	↑ cm	* mm
00960	30 / 25 / 20	34	6 - 9



**2-stufige Etagère**

2-tier tray  
bandeja dos alturas  
étagère carré 2 hauteurs



Naturschiefer

natural slate tray

bandeja de pizarra natural

plateau ardoise naturelle

	Ø cm	↑ cm	* mm
00989	25 / 20	24	6 - 9

# CUTTING BOARDS



00954  
Box

00953  
Schneidebrett

83615  
Tablett



## Tablett „BROTSTATION“

tray  
bandeja  
plateau

mit Antirutschfüßchen  
with non-slip feet  
con pies antideslizantes  
avec pieds antidérapants



cm                      ↑ cm

83615                      59,5 x 35,5                      3,5



00953  
Schneidebrett

83615  
Tablett

## Brotschneidebrett „BROTSTATION“

cutting board  
tabla de corte  
planche à découper

Buchenholz  
beech  
haya  
hêtre



cm                      ↑ cm

00953                      52 x 34                      2

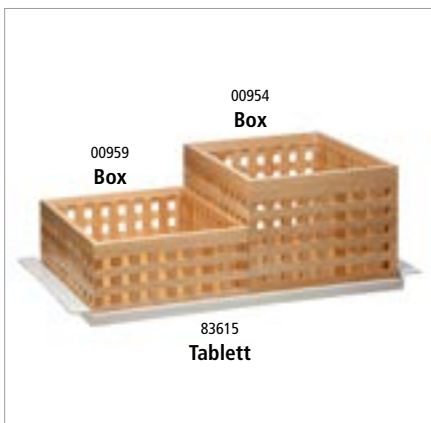

00959  
Box

83615  
Tablett

## Box „BROTSTATION“

box  
caja de pan  
boîte à pain

Buchenholz  
beech  
haya  
hêtre



cm                      ↑ cm

00959                      34 x 26                      12,5  
00954                      34 x 26                      20,0





**Brotschneidebrett „PROFI“**

cutting board  
tabla de cortar  
planche à découper



Eichenholz / oak wood / mader de roble / bois de chêne

	cm	↑ cm	
00806	58 x 37,5	4	



**Brotschneidebrett**

cutting board  
tabla de cortar  
planche à découper



Walnussholz / walnut wood / mader de nogal / bois de noyer

	cm	↑ cm	GN
00911	35,4 x 32,5	3,5	2/3



praktisches Krümfach  
practical crump shelf



praktisches Krümfach  
practical crump shelf

**Brotschneidebrett „LETTER“**

cutting board  
tabla de cortar  
planche à découper



Akazienholz / acacia wood / mader de acacia / bois d'acacia

	cm	↑ cm	
00886	48 x 34	3,5	



00885

**Brotschneidebrett**

cutting board  
tabla de cortar  
planche à découper



Akazienholz / acacia wood / mader de acacia / bois d'acacia

	cm	↑ cm	GN
00883	47,5 x 32,0	2	
00884	53,0 x 32,5	2	1/1
00885	60,0 x 40,0	2	



praktisches Krümfach  
practical crump shelf



00957

**Brotschneidebrett**

cutting board  
tabla de cortar  
planche à découper



Rubberwood / rubberwood / mader de caucho / bois d'hévéa

	cm	↑ cm	GN
00955	47,5 x 32,0	2	
00956	53,0 x 32,5	2	1/1
00957	60,0 x 40,0	2	



praktisches Krümfach  
practical crump shelf

# BUFFET GUARD

**3 Höhen einstellbar**  
3 heights adjustable

Servierbeispiel  
presentation example



**schwenkbar**  
swivelling



## Hygieneschutz „BUFFET GUARD“

sneeze guard  
protector anti aliento  
pare-haleine



- transparente, höhenverstellbare Acrylplatte 80 x 53 cm
- Neigungswinkel stufenlos einstellbar
- transparent, height-adjustable acrylic plate 80 x 53 cm
- tilt angle continuously adjustable
- placa acrílica transparente y de altura ajustable 80 x 53 cm
- el ángulo de inclinación es infinitamente variable
- plaque en acrylique transparente 80 x 53 cm et réglable en hauteur
- angle d'inclinaison variable à l'infini

	cm	↑ cm	mm	Fuß / base
98120	93 x 53	50,5	5	Metall schwarz / metal black



**Antirutschfüßchen**  
non-slip feet



**Der Neigungswinkel der Acrylplatte ist flexibel einstellbar**  
the angle of inclination of the acrylic plate is flexibly adjustable



**Höheneinstellung der Acrylplatte in 3 Höhen (20 cm - 30 cm - 40 cm)**  
height adjustment of the acrylic plate in 3 steps. (20 cm - 30 cm - 40 cm)



**Anwendungsbeispiel**  
application example



**Lieferung erfolgt demontiert**  
delivery takes place disassembled

# DRAWER SET



3 tlg.  
3 pcs.



mit Antirutsch Füßchen  
with non-slip feet



## Schubladen Set, 3-teilig

drawer set, 3 pcs.  
cajonera, set de 3  
set tiroir, set de 3

3-teiliges Set:

- 1 Ständer aus Metall schwarz
- 1 Schublade mit Griff schwarz
- 1 Schneidebrett aus geöltem Walnussholz

3 pcs. set:

- 1 stand made of metal black
- 1 drawer with handle black
- 1 oiled walnut wood cutting board

set de 3:

- 1 soporte de metal negro
- 1 cajón con asa negra
- 1 tabla de cortar de madera de nogal engrasada

set de 3:

- 1 support métallique noir
- 1 tiroir avec poignée noire
- 1 planche à découper en bois de noyer huilé



	cm	↑ cm
00910	35,4 x 32,5	20



Anwendungsbeispiele  
application examples

Einzelteile / parts / piezas / pièces

	cm	↑ cm	
00911	35,4 x 32,5	3,5	Schneidebrett / cutting board
00912	34,0 x 32,0	17,5	Schublade, Griff schwarz / drawer, handle black
00914	34,0 x 32,0	17,5	Schublade, Griff chrom / drawer, handle chrome
15503	35,4 x 32,5	17,6	GN Buffetständer chrom / GN buffet stand chrome
15506	35,4 x 32,5	17,6	GN Buffetständer schwarz / GN buffet stand black

# SNACKPRESENTER



## Snackpresenter

snackpresenter  
dispensador de bocadillos  
présentoir à sandwiches  
**mit Safrille und Griffmulde, passend für Vitrine 11888**  
with recessed grip, suitable for showcase 11888  
asa moldeada, apto para la vitrina 11888  
anse moulée, apte pour vitrine 11888



	cm	↑ cm	
11887	29 x 19	6,5	3 Mulden / 3 compartments 3 compartimentos / 3 compartiments
11889	60 x 19	7,5	6 Mulden / 6 compartments 6 compartimentos / 6 compartiments



## Snackpresenter

snackpresenter  
dispensador de bocadillos  
présentoir à sandwiches  
**hochglanzpoliert, mit Griffmulde, für 7 Baguettes**  
mirror polished, with recessed grip, for 7 baguettes  
pulido brillante, con asa empotrada, ideal para 7 bocadillos  
poli brillant, avec poignée encastrée, parfait pour 7 sandwiches



	cm	↑ cm
11891	47,5 x 10,5	6



## Snackpresenter

snackpresenter  
dispensador de bocadillos  
présentoir à sandwiches



	cm	↑ cm
11969	56 x 8	5,5



## Vitrine / Thekenaufsatz

showcase  
vitrina de mostrador  
vitrine de comptoir  
**rutschfest, aus einem Teil gefertigt**  
non-slip, monoblock produced  
antideslizante, fabricado en 1 pieza  
antidérapante, fabriquée en une seule pièce



	cm	↑ cm
11888	63,5 x 25	25



**Hygieneschutz**  
hygienic cover  
campana higiénica antialiento  
pare-haleine



	cm	↑ cm
11556	82 x 42	45



**Brötchenspender**  
roll dispenser  
dispensador de panecillos  
distributeur de petits pains



hygienisch und einfach zu reinigen, mit Krümelschale  
hygienic and easy to clean, with crumb tray  
higiénico y fácil de limpiar, con bandeja para migas  
hygiénique et facile à laver, avec plat ramasse-miettes

	cm	↑ cm	
11572	32,5 x 27,5	42	für ca. 45-50 Brötchen / for approx. 45-50 rolls para 45-50 panecillos / pour 45-50 petits pains
11573	32,5 x 27,5	56	für ca. 65-70 Brötchen / for approx. 65-70 rolls para 65-70 panecillos / pour 65-70 petits pains



**Buffetgestell**  
buffet stand  
soporte para buffet  
présentoir buffet



3-stufig, Rubberwood, geeignet für Körbe, platzsparend zusammenklappbar  
3-tier, rubberwood, usable for baskets, can be pushed together for place saving  
3 alturas, madera de caucho, apto para cestas, se puede plegar para ahorrar espacio  
3 hauteurs, bois d'hévéa, pour corbeilles, la structure s'ouvre ou se ferme pour réduire l'encombrement

	cm	↑ cm
33232	59 x 30,5	59

Tisch- und Buffetkorb, rund „ECONOMIC“ / buffet basket, round / cesta de buffet redonda / corbeille de buffet ronde

	Ø cm	↑ cm	Farbe / Colour
40144	39,0	10,0	



**Buffetgestell, 3-teilig**  
buffet stand, 3 pcs.  
expositor de buffet, set de 3  
présentoir buffet, set de 3



Rubberwood, 3-teilig:  
1. Fach 40 x 40 cm x H 33 cm;  
2. Fach 40 x 37 cm x H 20 cm;  
3. Fach 40 x 34 cm x H 9 cm

rubberwood, 3 pcs.:  
1. 40 x 40 cm x H 33 cm;  
2. 40 x 37 cm x H 20 cm;  
3. 40 x 34 cm x H 9 cm

	cm	↑ cm	Farbe / Colour	Wenge
11607	40 x 40	33		



**Neigungswinkel stufenlos einstellbar**  
inclination angle continuously adjustable

**für 3 versch. Haubengrößen**  
for 3 different cover sizes

06519 Ø 21 cm  
06520 Ø 30 cm  
06521 Ø 36 cm



**Haubenthalterung „FLEXIBLE“**

cover holder  
soporte de la campana  
support de la cloche



Bei dieser Haubenthalterung wird die Haube am Griff in die Vorrichtung gesteckt.  
Für APS-Hauben geeignet!

With this cover holder, the cover is inserted into the device by the handle.  
Suitable for APS covers!

Con este soporte de campana, la campana se cuelga simplemente por el asa.  
¡Para campanas de APS!

Avec ce support, la cloche s'accroche simplement par la poignée.  
Pour cloches APS!

	cm	↑ cm
33288	35,5 x 30	39

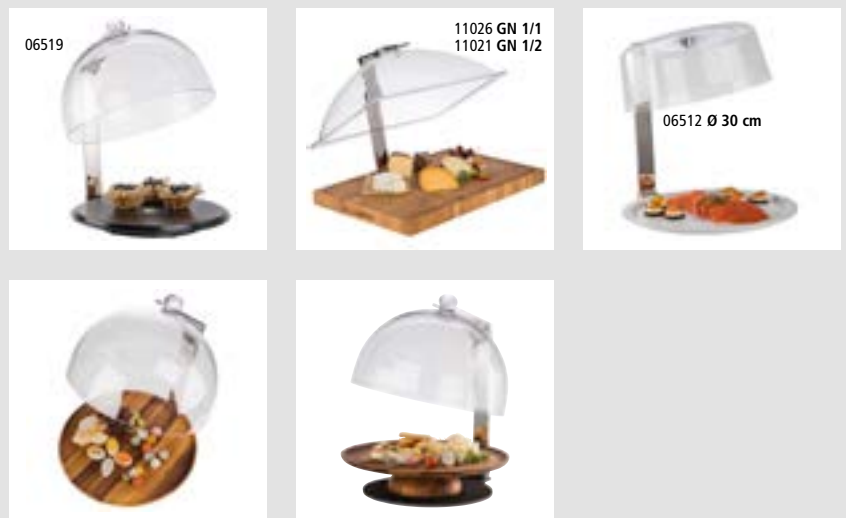

Anwendungsbeispiele  
application examples

**2 tlg.**  
2 pcs.



24 cm

**Haube | cover**  
Ø 16 cm



**Tablett | tray**  
Ø 18,5 cm

**Tablett mit Haube**

tray with cover  
bandeja con campana  
plateau avec cloche



2 teiliges Set:

- 1 Tablett aus geöltem Buchenholz (Ø 18,5 cm, H: 2,5 cm)
- 1 Glas-Haube (Ø 16 cm, H: 22,5 cm)

2 pcs.:

- 1 tray of oiled beech wood (Ø 18,5 cm, H: 2,5 cm)
- 1 glass cover (Ø 16 cm, H: 22,5 cm)

set de 2:

- 1 bandeja de madera de haya (Ø 18,5 cm, H: 2,5 cm)
- 1 campana de cristal (Ø 16 cm, H: 22,5 cm)

set de 2:

- 1 plateau de bois de hêtre (Ø 18,5 cm, H : 2,5 cm)
- 1 couvercle en verre (Ø 16 cm, H : 22,5 cm)

	Ø cm	↑ cm
00830	18,5	24



Präsentationsmöglichkeit  
presentation example



3 tlg.  
3 pcs.

**Multi Rack**  
multi rack  
dispensador en escalera  
support multiple



**2-stufig, 3-teilig:**  
• 1 Gestell matt poliert  
• 2 Schütten aus transparent gefroretetem Kunststoff, je ca. 1 Liter

2-tier, 3 pcs.:  
• 1 frame matt polished  
• 2 bowls frosted plastic, approx. 1 liter  
2 alturas - set de 3:  
• 1 soporte pulido mate  
• 2 cuencos de plástico glaseado, aprox. 1 litro

2 niveaux - set de 3:  
• 1 support poli mat  
• 2 bols en plastique mat, approx. 1 litre

	cm	↑ cm
11442	19 x 24	28



4 tlg.  
4 pcs.

**Multi Rack**  
multi rack  
dispensador en escalera  
support multiple



**3-stufig, 4-teilig:**  
• 1 Gestell matt poliert  
• 3 Schütten aus transparent gefroretetem Kunststoff, je ca. 1 Liter

3-tier, 4 pcs.:  
• 1 frame matt polished  
• 3 bowls frosted plastic, approx. 1 liter  
3 alturas, set de 4:  
• 1 soporte pulido mate  
• 3 cuencos de plástico glaseado, aprox. 1 litro

3 niveaux - set de 4:  
• 1 support poli mat  
• 3 bols en plastique mat, approx. 1 litre

	cm	↑ cm
11444	19 x 24	41



4 tlg.  
4 pcs.

**Multi Rack**  
multi rack  
dispensador en escalera  
support multiple



**4-stufig, 5-teilig:**  
• 1 Gestell matt poliert  
• 4 Schütten aus transparent gefroretetem Kunststoff, je ca. 1 Liter

4-tier, 5 pcs.:  
• 1 frame matt polished  
• 4 bowls frosted plastic, approx. 1 liter  
4 alturas, set de 5:  
• 1 soporte pulido mate  
• 4 cuencos de plástico glaseado, aprox. 1 litro

4 niveaux - set de 5:  
• 1 support poli mat  
• 4 bols en plastique mat, approx. 1 litre

	cm	↑ cm
11446	19 x 31	53



**Ergänzung für alle Multi-Racks**  
suplemento para todos los dispensadores  
compléments pour support multi-rack



**Schütte / canister / cuenco / bol**

	cm	↑ cm	ltr.
11455	19,5 x 16,5	10,5	1,0



# BUFFET STANDS



## Buffetständer „STAR“

buffet stand  
soporte para buffet  
présentoire buffet

**Metall, mit schwarzer Antirutschbeschichtung**

metal, with black anti-slide coating  
metal, con revestimiento antideslizante negro  
métal, avec revêtement antidérapant noir



	↑ cm
33260	8
33261	12
33262	18



## Buffetständer „MULTI“

buffet stand  
soporte para buffet  
présentoir buffet

**Metall, mit schwarzer Antirutschbeschichtung**

metal, with black anti-slide coating  
metal, con revestimiento antideslizante negro  
métal, avec revêtement antidérapant noir



	Ø cm	↑ cm
33269	15,5 / 18	8
33270	15,5 / 18	10
33271	15,5 / 18	18

	cm	↑ cm
33249	18 x 18	5
33250	18 x 18	8
33251	18 x 18	10
33252	18 x 18	18



## Buffetständer „PRISMA“

buffet stand  
soporte para buffet  
présentoir buffet

**Metall, mit schwarzer Antirutschbeschichtung**

metal, with black anti-slide coating  
metal, con revestimiento antideslizante negro  
métal, avec revêtement antidérapant noir



	Ø cm	↑ cm
33272	20	10,5
33273	20	20,0





**Buffetständer „KING“**

buffet stand  
soporte para buffet  
présentoir buffet

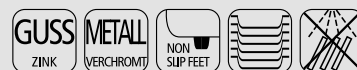

kein Verrutschen, Arme und Boden sind mit Antirutschflächen ausgestattet, schwere standsichere Qualität, Fuß dient als Löffelablage

the arms and base are equipped with non-slip surfaces, stable quality, base serves as spoon holder

revestimiento antideslizante en las puntas de los brazos y en la base, estable y alta calidad, la base sirve como reposacuchara

revêtement antidérapant sur les extrémités des 3 pieds et sur la base, robuste, stable et bonne qualité, la base sert de support pour les couverts

	Ø cm	↑ cm
03622	15	14
03623	15	21

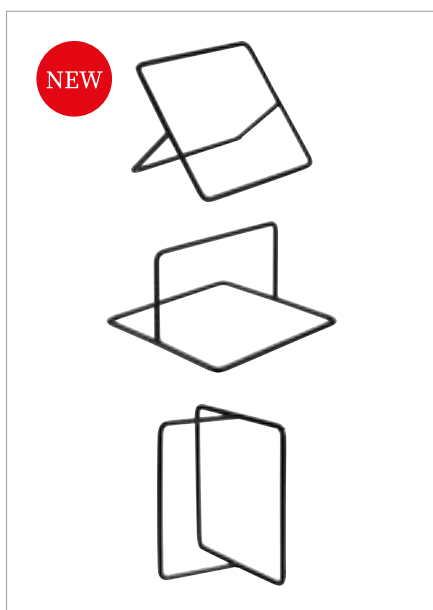

**Buffetständer „SQUARE“**

buffet stand  
soporte para buffet  
présentoir buffet



Metall, mit schwarzer Antirutschbeschichtung

metal, with black anti-slide coating

metal, con revestimiento antideslizante negro

métal, avec revêtement antidérapant noir

	cm	↑ cm
33305	12 x 12	7



Präsentationsmöglichkeit | presentation example



**Buffetständer „PERFECTO“**

buffet stand  
soporte para buffet  
présentoir buffet



Metall, mit schwarzer Antirutschbeschichtung

metal, with black anti-slide coating

metal, con revestimiento antideslizante negro

métal, avec revêtement antidérapant noir

	cm	↑ cm	fits to
33304	19 x 23	40,5	33202, 33303



**Buffetständer „FRIDA“**

buffet stand  
soporte para buffet  
présentoir buffet



Metall, mit schwarzer Antirutschbeschichtung

metal, with black anti-slide coating

metal, con revestimiento antideslizante negro

métal, avec revêtement antidérapant noir

	Ø cm	↑ cm	fits to
33282	23 / 30,5	17	85230, 85231

## BUFFET STANDS

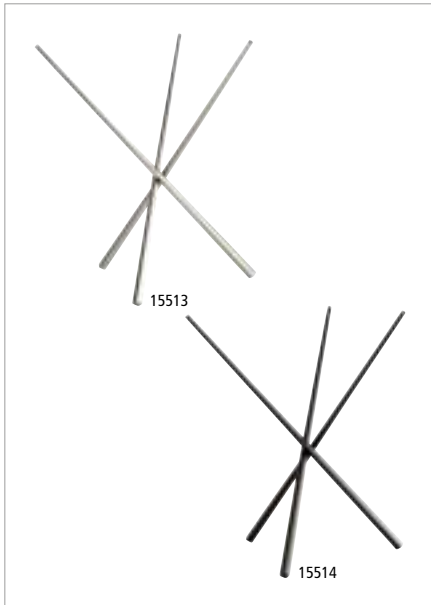

### Buffetständer „ASIA PLUS“

buffet stand  
soporte para buffet  
présentoir buffet



	Ø cm	↑ cm	Farbe / Colour
15513	20,5 / 16,5	20	Grey
15514	20,5 / 16,5	20	Black



Präsentationsmöglichkeit  
presentation example



### Buffetständer

buffet stand  
expositor de buffet  
présentoir buffet



Akazienholz  
acacia wood  
madera de acacia  
bois d'acacia

	Ø cm	↑ cm
33255	15	10
33256	25	15



Präsentationsmöglichkeit  
presentation example



### Buffetständer „WOOD“

buffet stand  
soporte para buffet  
présentoire buffet



Akazienholz, liegend oder stehend, variable Nutzungsmöglichkeiten  
acacia wood, usable by lying or standing, variable usage possibilities  
madera de acacia, se puede usar tumbado o de pie, opciones de uso variable  
bois d'acacia, possibilités d'utilisation variables

	cm	↑ cm	Farbe / Colour
33280	20 x 20	17,5	Yellow
33281	20 x 20	17,5	Black



liegend oder stehend, variable Nutzungsmöglichkeiten  
vertically or horizontally, variable usage possibilities

# HOCHSTAPLER



**Distanzstücke erhöhen die Nutzhöhe auf 4 cm**

## GN 1/1 System-Tablett „PROFI LINE“

GN 1/1 tray  
GN 1/1 bandeja  
GN 1/1 plateau



Dekorrand, hochglanzpoliert, Griffe verchromt, Distanzstücke erhöhen die Nutzhöhe auf 4 cm  
decor edge, mirror polished, chrome plated handles, spacers increase the useful height to 4 cm  
borde decorado pulido brillante, asas cromadas, los separadores aumentan la altura útil a 4 cm  
bord avec reliefs poli brillant, poignées chromées, les entretoises portent la hauteur utile à 4 cm

	cm	↑ cm	GN
11300	53 x 32,5	5,5	1/1

11150  
**mit verchromten Griffen**

11155  
**mit vergoldeten Griffen**

## GN 1/1 System-Tablett „BUFFET-STAR“

GN 1/1 tray  
GN 1/1 bandeja  
GN 1/1 plateau



Rand hochglanzpoliert, Distanzstücke erhöhen die Nutzhöhe auf 4 cm  
mirror polished edge, spacers increase the useful height to 4 cm  
borde pulido brillante, los separadores aumentan la altura útil a 4 cm  
bord poli brillant, les entretoises portent la hauteur utile à 4 cm

	cm	↑ cm	GN	Griff / handle
11150	53 x 32,5	6,5	1/1	gold
11155	53 x 32,5	6,5	1/1	silver

**für platzsparende Servieren, Lagern und Transportieren**  
for space-saving serving, storing and transporting

## GN 1/1 System-Tablett „CLASSIC“

GN tray  
GN bandeja  
GN plat empilable système catering



Rand hochglanzpoliert, Distanzstücke erhöhen die Nutzhöhe auf 4 cm  
mirror polished edge, spacers increase the useful height to 4 cm  
borde pulido brillante, los separadores aumentan la altura útil a 4 cm  
bord poli brillant, les entretoises portent la hauteur utile à 4 cm

	cm	↑ cm	GN
11295	53 x 32,5	5,0	1/1

11305  
**Haube / cover**

11300  
**Tablett / tray**

## GN 1/1 Haube „HOCHSTAPLER“

GN 1/1 cover  
GN 1/1 campana  
GN 1/1 cloche



glasklarer Kunststoff, Haube fixiert sich auf dem Tablett, nahezu bruchfest  
clear plastic, cover fixes itself on the tray, nearly unbreakable  
plástico transparente, la tapa se fija a la bandeja para que no se deslice, resistente a la rotura  
en plastique transparent, la cloche se fixe sur le dessous du plateau, résistant à la casse

	cm	↑ cm	fits to	GN
11305	53 x 32,5	9	11300, 11295	1/1



11065

**GN Behälter „PROFI LINE“**

GN pan  
GN cubeta  
GN bac



	cm	↑ cm	GN	ltr.
11020	53,0 x 32,5	2,0	1/1	1,7
11040	53,0 x 32,5	4,0	1/1	3,4
11065	53,0 x 32,5	6,5	1/1	7,0
12065	32,5 x 26,5	6,5	1/2	3,3



11100

11000

11110

**GN Tablett „PROFI LINE“**

GN tray  
GN bandeja  
GN plateau



mit glattem Rand / with smooth edge / borde liso / bord lisse

	cm	↑ cm	GN
11100	53,0 x 32,5	1,5	1/1
12100	32,5 x 26,5	1,5	1/2

mit Dekor-Rand / with decor-edge / con borde decorado / bords avec relief

	cm	↑ cm	GN
11000	53,0 x 32,5	1,5	1/1
12000	32,5 x 26,5	1,5	1/2

glatter schmaler Rand / smooth narrow edge / borde estrecho liso / bord étroit lisse

	cm	↑ cm	GN
11110	53,0 x 32,5	1,0	1/1



11038

11048

**Tablett „PROFI LINE“**

tray  
bandeja  
plateau



Dekorrand hochglanzpoliert  
decor edge mirror polished  
borde decorado pulido brillante  
contour relief poli brillant

	Ø cm	↑ cm
11032	32	2,5
11038	38	2,5
11048	48	2,5



11041

11042

**GN Abdeckhaube**

GN cover  
GN campana  
GN cloche



	cm	↑ cm	✱ mm	GN
11041	32,5 x 26,5	9,5	3	1/2
11042	53,0 x 32,5	9,5	3	1/1
11043	32,5 x 17,6	10,5	3	1/3
11044	53,0 x 16,2	10,5	3	2/4



**Tablett „SCHÖNER ESSEN“**

tray  
bandeja  
plateau



mit Dekorrand, Griffe Zinkdruckguss verchromt, genietet

with decor edge, handles zinc alloy chrome plated, riveted

borde decorado, asas de fundición inyectada de cinc cromado, remachadas

bord décor, poignées en zamac chromé, rivetées

	cm	↑ cm
00082	52 x 31,0	3,0
00081	60 x 36,0	3,0
00084	75 x 44,5	3,0



**Tablett „SCHÖNER ESSEN“**

tray  
bandeja  
plateau



	cm	↑ cm	GN
00383	35,0 x 24,0	1,0	
00382	42,0 x 31,0	1,0	
00381	50,0 x 36,0	1,0	
00384	63,5 x 44,5	1,0	
00385	60,0 x 40,0	1,0	
00388	53,0 x 32,5	1,0	1/1

leichte Ausführung 0,5 mm / light model / modelo ligero / qualité légère

	cm	↑ cm
03824	42,0 x 31,0	1,0



**Tablett „SCHÖNER ESSEN“**

tray  
bandeja  
plateau



	cm	↑ cm
00087	38 x 23	1,5



**Tablett „SCHÖNER ESSEN“**

tray  
bandeja  
plateau



	Ø cm	↑ cm
00075	31	1,0
00085	35	1,0



**Tablett mit Haube „SCHÖNER ESSEN“**

tray with cover  
bandeja con campana  
plateau avec cloche



	cm	↑ cm
38202	42 x 31	8

Haube / cover / campana / cloche

	cm	↑ cm
08201	36,5 x 26,0	7,5



**Schale**

bowl  
cuenco  
bol

**ingerollter Rand**

rolled edge  
borde enrollado  
bord roulé



	cm	↑ cm	ltr.
40110	26,5 x 18,5	4,0	0,8
40115	31,0 x 21,0	4,5	1,3



**Servierpfanne**

pan  
fuente para la mesa  
plat pour la table

**mit vergoldeten Edelstahlgriffen, 1 mm dick**

with gold-plated stainless steel handles, 1 mm thick  
con asas doradas de acero inoxidable de 1 mm de grosor  
avec poignées dorées en acier inox, 1 mm d'épaisseur



	cm	↑ cm	ltr.
61190	19	3,5	0,7
61280	28	4,0	2,0
61400	40	5,0	4,5
60270	26,5 x 19,5	3	0,8
60310	31,0 x 21,5	3	1,2



**Edelstahltablett „FOCUS“**

tray  
bandeja  
plateau



	cm	↑ cm
09010	43,5 x 32,5	1,5

**Rolltophaube „FOCUS“ / rolltop cover / campana abatible / cloche basculante**

	cm	↑ cm
09013	44 x 33,5	17



**Tablett „ELEGANCE“**

tray  
bandeja  
plateau



	cm	↑ cm
02310	41 x 26	1,0
02311	48 x 30	1,0
02312	60 x 37	1,0



**Tablett „FINESSE“**

tray  
bandeja  
plateau



verchromte Messinggriffe / chrome plated brass handles / asas plateadas de latón / poignées en laiton chromées

	Ø cm	↑ cm
01738	38	1,5
01748	48	1,5



**Tablett „FINESSE“**

tray  
bandeja  
plateau



verchromte Messinggriffe / chrome plated brass handles / asas plateadas de latón / poignées en laiton chromées

	cm	↑ cm
01712	44 x 31	1,5
01711	52 x 38	1,5
01710	60 x 42	1,5
01709	70 x 48	1,5



**Tablett „FINESSE“**

tray  
bandeja  
plateau



	cm	↑ cm
01322	42 x 30	2,5
01323	50 x 36	2,5
01324	60 x 41	2,5
01325	70 x 46	2,5



**Tablett „FINESSE“**

tray  
bandeja  
plateau



	Ø cm	↑ cm
01332	32,0	1,0
01335	35,0	1,0
01338	38,0	1,0
01348	48,0	1,0



**Tablett „FINESSE“**

tray  
bandeja  
plateau



	cm	↑ cm
01314	30 x 24	1,0
01313	35 x 24	1,0
01317	39 x 26	1,0
01312	42 x 31	1,0
01318	48 x 30	1,0
01311	50 x 38	1,0
01310	58 x 42	1,0
01309	68 x 48	1,0



**Tablett mit Haube „FINESSE“**

tray with cover  
bandeja con campana  
plateau avec cloche

**2-teilig: Tablett aus Edelstahl + Haube**

2 pcs.: stainless steel tray + cover  
set de 2: bandeja de acero inoxidable + campana  
set de 2: plateau en acier inox + cloche



	cm	↑ cm
13122	42 x 31	8,5



**Tablett mit Haube „FINESSE“**

tray with cover  
bandeja con campana  
plateau avec cloche

**2-teilig: Tablett aus Edelstahl + Haube**

2 pcs.: stainless steel tray + cover  
set de 2: bandeja de acero inoxidable + campana  
set de 2: plateau en acier inox + cloche



	Ø cm	↑ cm
13622	22	9,5



**Tablett mit Haube „FINESSE“**

tray with cover  
bandeja con campana  
plateau avec cloche

**2-teilig: Tablett aus Edelstahl + Haube**

2 pcs.: stainless steel tray + cover  
set de 2: bandeja de acero inoxidable + campana  
set de 2: plateau en acier inox + cloche



	Ø cm	↑ cm	Ø cm Hauben / cover
13382	38	12	30
13385	38	13	33



**Tablett mit Haube**

tray with cover  
bandeja con campana  
plateau avec cloche

**2-teilig: Tablett aus Edelstahl, hochglanzpoliert + Haube**

2 pcs.: stainless steel tray, mirror polished + cover  
set de 2: bandeja de acero inoxidable, pulido brillante + campana  
set de 2: plateau en acier inox, poli brillant + cloche



	Ø cm	↑ cm
00827	27	12,5



**Tablett mit Haube**

tray with cover  
bandeja con campana  
plateau avec cloche

**2-teilig: Tablett aus Edelstahl, hochglanzpoliert + Haube**

2 pcs.: stainless steel tray, mirror polished + cover  
set de 2: bandeja de acero inoxidable, pulido brillante + campana  
set de 2: plateau en acier inox, poli brillant + cloche



	cm	↑ cm
00828	30 x 15,5	10,5





**Tablett mit Haube „ELEGANCE“**

tray with cover  
bandeja con campana  
plateau avec cloche

**2-teilig: Tablett aus Edelstahl + Haube**

2 pcs.: stainless steel tray + cover  
set de 2: bandeja de acero inoxidable + campana  
set de 2: plateau en acier inox + cloche



	cm	↑ cm
23642	35 x 19	10



**Tablett mit Haube „ELEGANCE“**

tray with cover  
bandeja con campana  
plateau avec cloche

**2-teilig: Tablett aus Edelstahl + Haube**

2 pcs.: stainless steel tray + cover  
set de 2: bandeja de acero inoxidable + campana  
set de 2: plateau en acier inox + cloche



	cm	↑ cm
00064	33 x 17	10
00067	25 x 19	7

Haube für 00064 / cover for 00064 / campana para 00064 / cloche pour 00064

06401

Haube für 00067 / cover for 00067 / campana para 00067 / cloche pour 00067

06701



**Tortenplatte**

cake plate  
bandeja tartas  
plat à gâteau

**2-teilig: Tablett aus Edelstahl + Haube**

2 pcs.: stainless steel tray + cover  
set de 2: bandeja de acero inoxidable + campana  
set de 2: plateau en acier inox + cloche



	Ø cm	↑ cm	
00065	30	11	mit 1 Haube / with 1 cover
00652	30	7 + 11	mit 2 Hauben / with 2 cover



**Tortenplatte „BAROCK“**

cake plate  
bandeja tartas  
plat à gâteau

**2-teilig: Tortenplatte mit Barock-Rand + Haube**

2 pcs.: cake plate with decor edge „Barock“ + cover  
set de 2: porta tartas, borde decor „Barock“ + campana  
set de 2: plateau bord décor „Barock“ + cloche



	Ø cm	↑ cm
06503	32	10

Frischhaltehaube / cover / campana / cloche

	Ø cm	↑ cm
06510	30	11,5



**Rolltop-Set**  
rolltop set  
set rolltop  
set cloche à fromage



**2-teilig:** Tablett + Rolltophaube glasklar, rutschfeste Haubenfixierung, klappbar  
2 pcs.: tray + rolltop cover, cover non-slip fixed, mountable  
set de 2: bandeja + campana abatible fijación antideslizante, montable  
set de 2: plateau + cloche abatante, fixation antidérapants, montable

	Ø cm	↑ cm
09080	38	24
09099	50	28



**Rolltop-Set, 3-teilig**  
rolltop set, 3 pcs.  
rolltop, set de 3  
rolltop, set de 3



**1 Edelstahltablett Ø 38 cm + 1 Naturschieferplatte Ø 33 cm + 1 Rolltophaube Ø 38 cm**  
1 stainless tray Ø 38 cm + 1 natural slate tray Ø 33 cm + 1 rolltop cover Ø 38 cm  
1 bandeja de acero inoxidable Ø 38 cm + 1 bandeja de pizarra natural Ø 33 cm + 1 tapa abatible Ø 38 cm  
1 plat inox Ø 38 cm + 1 plat ardoise naturelle Ø 33 cm + 1 cloche Ø 38 cm

	Ø cm	↑ cm
01000	38	24



**Kaviarkühler**  
caviar cooler  
enfriador de caviar  
rafraîchisseur de caviar



**4-teilig: 1 Edelstahlschale, 1 Halter, 1 Glasschale, 1 Edelstahldeckel**  
4 pcs.: 1 stainless steel bowl, 1 holder, 1 glass bowl Ø 10 cm, 1 stainless steel cover  
set de 4: 1 bol de acero inoxidable, 1 soporte, 1 bol de vidrio Ø 10 cm, 1 tapa de acero inoxidable  
set de 4: 1 bol en acier inox, 1 support, 1 bol en verre Ø 10 cm, 1 couvercle en acier inox

	Ø cm	↑ cm
01699	18	12



**Serviertöpfchen „MUMBAI“**  
small serving pot  
olla pequeña de servir  
marmite petite de servir  
gehämmerte Oberfläche  
hammered surface  
superficie martillada  
surface martelée



	Ø cm	↑ cm	ltr.	Griff / handle cm
40186	9,5	5,5	0,30	2,5
40187	13,5	5,0	0,55	3,0
40188	15,5	5,0	0,75	3,0



**Tablett mit Haube**

tray with cover  
bandeja con campana  
plateau avec cloche



2 teilig: Tablett aus geöltem Buchenholz (Ø 18,5 cm, H: 2,5 cm) + Glas-Haube (Ø 16 cm, H: 22,5 cm)

2 pcs.: tray of oiled beech wood + glass cover  
set de 2: bandeja de madera haya + campana de cristal  
set de 2 : plateau en bois de hêtre + cloche en verre

	Ø cm	↑ cm
00830	18,5	24



**Tablett mit Haube, 2-teilig**

tray with cover, 2 pcs.  
bandeja con campana, set de 2  
plateau avec cloche, set de 2



Tablett aus Bambus, ölprägniert + Haube

bamboo tray, oil-impregnated + cover  
bandeja de bambú, impregnada de aceite + campana  
plateau en bambou, imprégné d'huile + cloche

	Ø cm	↑ cm
00825	25	13,5



**Tablett mit Haube, 2-teilig**

tray with cover, 2 pcs.  
bandeja con campana, set de 2  
plateau avec cloche, set de 2



Tablett aus Bambus, ölprägniert + Haube

bamboo tray, oil-impregnated + cover  
bandeja de bambú, impregnada de aceite + campana  
plateau en bambou, imprégné d'huile + cloche

	cm	↑ cm
00826	28 x 14	11,5



**Tablett mit Haube, 2 teilig**

tray with cover, 2 pcs.  
bandeja con campana, set de 2  
plateau avec cloche, set de 2



Tablett aus Bambus, ölprägniert + Haube

bamboo tray, oil-impregnated + cover  
bandeja de bambú, impregnada de aceite + campana  
plateau en bambou, imprégné d'huile + cloche

	Ø cm	↑ cm
00822	20,5	10

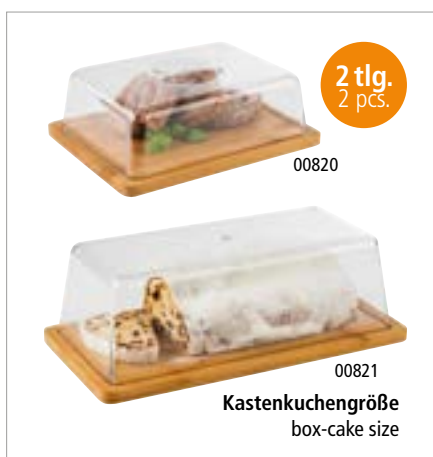

**Tablett mit Haube, 2 teilig**

tray with cover, 2 pcs.  
bandeja con campana, set de 2  
plateau avec cloche, set de 2



Tablett aus Bambus, ölprägniert + Haube

bamboo tray, oil-impregnated + cover  
bandeja de bambú, impregnada de aceite + campana  
plateau en bambou, imprégné d'huile + cloche

	cm	↑ cm
00820	24 x 18,5	8
00821	32 x 16,5	11



00393 oder / or 00396  
96 x

00391 oder / or 00398  
96 x

00392 oder / or 00399  
96 x

00394 oder / or 00395  
96 x

**Warenträger**  
display | expositor | présentoir

- für Partyplatten**
- platzsparende flexible Präsentation durch geringe Abmessungen
  - als Zweitplatzierung für Ihre zusätzlichen Umsätze
  - in weiß lieferbar
- para bandejas party
- presentación flexible que ahorra espacio gracias a sus pequeñas dimensiones
  - como colocación secundaria para sus ventas adicionales
  - disponible en blanco

- for party trays
- space-saving flexible presentation due to small dimensions
  - as secondary placement for your additional sales
  - available in white
- pour les plateaux party
- présentation flexible peu encombrante grâce à ses dimensions réduites
  - comme deuxième emplacement pour vos ventes supplémentaires
  - disponible en blanc

	cm	↑ cm
00397	55 x 65	190



Ø 35 cm

00396 round

00398 oval

GN 1/1 00395

**Partyplatte „CLASSIC“**

- partytray  
bandeja party  
plateau party
- Rand eingerollt**  
rolled edge  
borde enrollado  
bord enroulé



	cm	↑ cm	GN		VE / unit
00396	Ø 35	1,5	-	round	48
00398	46,0 x 34,0	1,5	-	oval	48
00399	41,0 x 31,0	1,5	-		48
00389	35,4 x 32,5	1,5	2/3		48
00395	53,0 x 32,5	1,5	1/1		36



Ø 35 cm

00393 round

00391 oval

00392

**Partyplatte „CLASSIC“**

- partytray  
bandeja party  
plateau party
- Rand eingerollt**  
rolled edge  
borde enrollado  
bord enroulé



	cm	↑ cm		VE / unit
00393	Ø 35	1,5	round	48
00391	46 x 34	1,5	oval	48

	cm	↑ cm	GN	VE / unit
00392	41 x 31	1,5	-	48
00394	53 x 32,5	1,5	1/1	48





**Serviertablett „KAFFEEHAUS“**

tray  
bandeja  
plateau

hochglanzpoliert, stabiler Rand eingerollt  
mirror polished, stable edge rolled in  
pulido brillante, borde estable enrollado  
poli brillant, bord stable enroulé



	cm	↑ cm	
30148	Ø 27	1,5	
30149	30 x 15,5	1,5	

passende Hauben / cover / campana / cloche



	cm	↑ cm	suitable for
11055	Ø 23	12,0	30148
11056	26 x 12	10,0	30149



Servierbeispiel  
presentation example



**Serviertablett „KAFFEEHAUS“**

tray  
bandeja  
plateau

matt poliert, oval, Rand eingerollt  
matt polished, oval, rolled edge  
pulido mate, oval, borde enrollado  
poli mat, ovale, bord enroulé



	cm	↑ cm	
30111	20,0 x 14,5	0,5	für Zucker und Sahne / for sugar and cream
30112	26,5 x 19,5	0,5	für eine Tasse / for one cup
30113	29,0 x 22,0	0,5	für zwei Tassen / for two cups



Antik-Edelstahl-Look

stainless steel antique look  
acero estilo antiguo  
acier style antique



	cm	↑ cm	
30140	20,0 x 14,5	1,0	für Zucker und Sahne / for sugar and cream
30141	26,5 x 19,5	1,0	für eine Tasse / for one cup
30142	29,0 x 22,0	1,0	für zwei Tassen / for two cups



**Serviertablett „KAFFEEHAUS“**

tray  
bandeja  
plateau

hochglanzpoliert, oval, Rand eingerollt  
mirror polished, oval, rolled edge  
pulido brillante, ovalado, borde enrollado  
poli brillant, ovale, bord enroulé



	cm	↑ cm	
30115	20,0 x 14,5	0,5	für Zucker und Sahne / for sugar and cream para azúcar y crema / pour le sucre et la crème
30116	26,5 x 19,5	0,5	für eine Tasse / for one cup para una taza / pour une tasse
30117	29,0 x 22,0	0,5	für zwei Tassen / for two cups para dos tazas / pour deux tasses



Serviertablett „KAFFEEHAUS“

tray  
bandeja  
plateau

**matt poliert, Rand eingerollt**  
matt polished, rolled edge  
pulido mate, borde enrollado  
poli mat, bord enroulé



	cm	↑ cm
30118	21,5 x 13	1,5
30119	23,0 x 23	1,5
30120	20,0 x 11	1,5
30121	29,0 x 20	1,5



Serviertablett „KAFFEEHAUS“

tray  
bandeja  
plateau

**matt poliert, oval**  
matt polished, oval  
pulido mate, oval  
poli mat, ovale



	cm	↑ cm
30126	25,5 x 19,5	2



Serviertablett „KAFFEEHAUS“

tray  
bandeja  
plateau

	cm	↑ cm	Farbe / Colour
84251	26,0 x 20,0	1,5	■
84253	28,5 x 21,5	1,5	■



Serviertablett „KAFFEEHAUS“

tray  
bandeja  
plateau

**Innenfläche ziseliert, Rand eingerollt**  
chiselled inner surface, rolled edge  
superficie interior cincelada, borde enrollado  
surface intérieure ciselée, bord enroulé



	cm	↑ cm	VE / unit
30114	30 x 22	1,0	48



**Tablett „VINTAGE“**

tray  
bandeja  
plateau

**Antik-Edelstahl-Look**

stainless steel antique look  
acero estilo antiguo  
acier style antique



	cm	↑ cm
30130	26,0 x 13,5	1,5
30131	34,0 x 18,0	1,5
30132	38,0 x 26,5	1,5
30133	25,5 x 16,0	3,0
30134	32,5 x 21,5	2,0

passende Schälchen / fitting bowls / cuencos adecuados / bols apropiés



	Ø cm	↑ cm	ltr.
40655	7,5	5,5	0,17
40656	7,5	10,0	0,35

Wachspapier / greaseproof paper squares / papel alimenticio / papier alimentaire

	cm	pcs.	Motiv:
40670	42 x 25	500	Zeitung



Servierbeispiel  
presentation example



**Tablett „TREND“**

baking sheet  
bandeja  
plateau

**ein Backblech wird zum Serviertablett**

a baking sheet which becomes a serving tray  
una bandeja de hornear que se convierte en una bandeja de servir  
un moule qui devient un plateau de service



	cm	↑ cm
13380	32 x 21,5	2

# NATURAL SLATE



**EXTRA STRONG**  
6-9 mm thickness

Naturschiefer speichert auf natürliche Weise Kälte besonders gut. Die Kanten der Platten sind gebrochen und nicht gesägt.

Natural slate stores cold particularly well in a natural way. The edges of the panels are broken and not sawn.

La pizarra natural almacena el frío especialmente bien de forma natural. Los bordes de las bandejas están rotos y no aserrados.

L'ardoise naturelle stocke particulièrement bien le froid de manière naturelle. Les bords des plateaux sont brisés et non sciés.

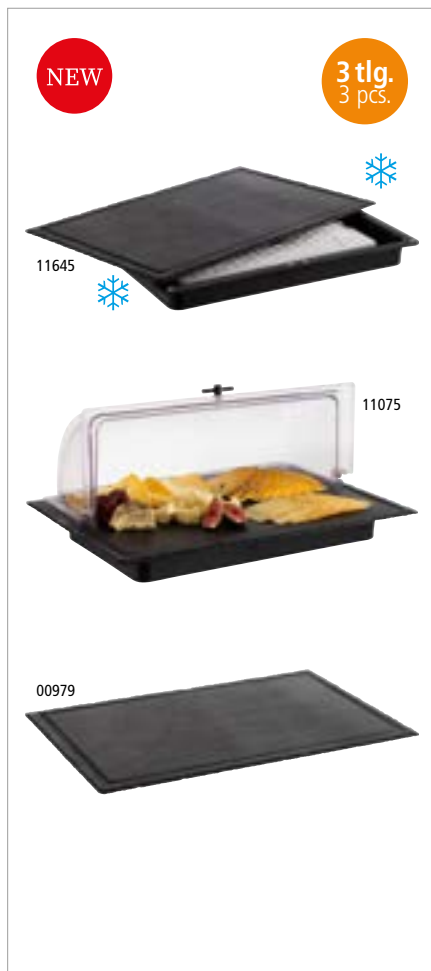

## Kühlbox „SLATE“ refrigerated buffet display expositor buffet frío plateau buffet froid

3-teilig, bestehend aus: 1 Basis aus schwarzem Polystyrol,  
1 Naturschieferplatte, 1 Kühlakku (ohne Haube)  
3 pcs., set consists of: 1 base made of black polystyrene, 1 natural slate tray, 1 cooler (without cover)

set de 3 compuesto por: 1 soporte de poliestireno negro, 1 bandeja de pizarra natural, 1 acumulador de frío (sin campana)

set de 3 composé de: 1 support en polystyrène noir, 1 plateau en ardoise naturelle, 1 accumulateur de froid (sans couvercle)



	cm	↑ cm
11645	58 x 38	6,5

## Naturschieferplatte / natural slate tray / bandeja de pizarra natural / plateau ardoise naturelle

	cm	* mm
00979 <small>NEW</small>	58 x 38	6 - 9

## Kühlakku / cooler / acumulador de frío / accumulateur de froid

	cm	↑ cm
10782	41 x 21	2,5

## Basis / base / soporte / support

	cm	↑ cm
11619 <small>NEW</small>	52 x 32	5,5

## GN Rolltophaube mit schwarzem Griff / GN rolltop cover with black handle / GN campana rolltop con mango negro / GN cloche rolltop avec poignée noire

	cm	↑ cm	GN
11075 <small>NEW</small>	53 x 32,5	19	1/1



## GN 1/1 Naturschieferplatte „HOCHSTAPLER“ GN 1/1 natural slate tray GN 1/1 bandeja de pizarra natural GN 1/1 plat ardoise naturelle



	cm	↑ cm	* mm
00966	53 x 32,5	6	6 - 9



Griffe verchromt, 4 cm Nutzhöhe  
chrome plate handles, 4 cm distance





**GN Naturschieferplatten**  
 GN natural slate tray  
 GN bandeja de pizarra natural  
 GN plat ardoise naturelle



	cm	✱ mm	GN
00990	53,0 x 32,5	6 - 9	1/1
00991	32,5 x 26,5	6 - 9	1/2
00992	32,5 x 17,6	6 - 9	1/3
00993	26,5 x 16,2	6 - 9	1/4
00973	53,0 x 16,2	6 - 9	2/4



**Naturschieferplatte**  
 natural slate tray  
 bandeja de pizarra natural  
 plat ardoise naturelle



	cm	✱ mm	
00996	45 x 30	6 - 9	
00979	58 x 38	6 - 9	mit Safrille / with juice groove

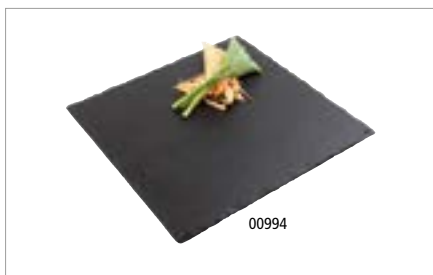

**Naturschieferplatte**  
 natural slate tray  
 bandeja de pizarra natural  
 plat ardoise naturelle



	cm	✱ mm
00994	25 x 25	6 - 9
00995	30 x 30	6 - 9



**Naturschieferplatte**  
 natural slate  
 bandeja de pizarra natural  
 plateau ardoise naturelle



	cm	✱ mm
00941	24,0 x 15,0	6 - 9
00942	26,5 x 20,5	6 - 9
00943	47,0 x 10,0	6 - 9
00988	30,0 x 12,0	6 - 9

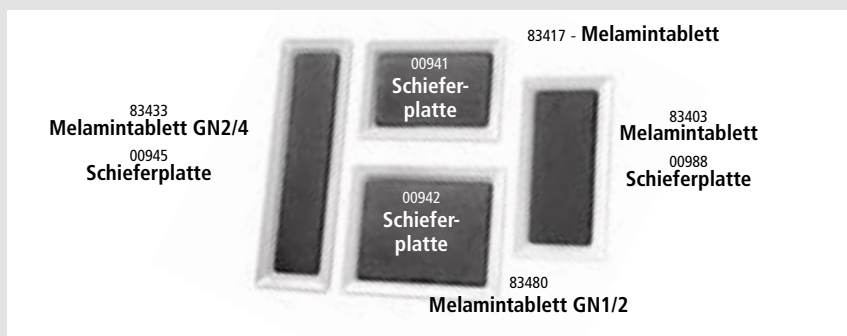



**Naturschieferplatte**  
 natural slate tray  
 bandeja pizarra natural  
 plat ardoise naturelle

**mit Saftrille, Ø 9,5 cm Aussparung**  
 with juice groove, with hole Ø 9,5 cm  
 con ranura para líquidos, con agujero Ø 9,5 cm  
 avec rigole, avec trou Ø 9,5 cm



	cm	✱ mm
00947	33 x 24	6 - 9

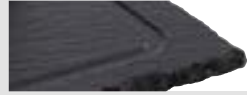

**mit Saftrille**  
 with juice groove

**Wachspapier / greaseproof paper squares / papel alimenticio / papier alimentaire**

	cm	pcs.	Motiv: Zeitung
40670	42 x 25	500	

**Servier-Frittierkorb / fry baskets / cestitas para el servicio mesa / paniers pour le service sur table**

	Ø cm	↑ cm	Griff / handle cm	Farbe / Colour
40601	9	8,5	9,0	stainless steel
40603	9	8,5	9,0	gold
40625 <b>NEW</b>	9	8,5	9,0	black mat



**Naturschieferplatte**  
 natural slate tray  
 bandeja pizarra natural  
 plat ardoise naturelle

**mit 3 x Ø 6 cm Aussparung**  
 with 3 holes, Ø 6 cm  
 con 3 agujeros, Ø 6 cm  
 avec 3 trous, Ø 6 cm



	cm	✱ mm
00987	28 x 10	6 - 9



**Naturschieferplatte**  
 natural slate tray  
 bandeja pizarra natural  
 plat ardoise naturelle

**mit Ø 6 cm Aussparung**  
 with hole Ø 6 cm  
 con agujero Ø 6 cm  
 avec trou Ø 6,0 cm



	cm	✱ mm
00986	25 x 12	6 - 9



**Naturschieferplatte / Untersetzer**  
 natural slate tray  
 bandeja de pizarra natural  
 plateau ardoise naturelle

**mit 2 x Ø 6 cm Aussparung**  
 with 2 holes Ø 6 cm  
 con 2 agujeros Ø 6 cm  
 avec 2 trous Ø 6 cm



	cm	✱ mm
00971	15 x 8	6 - 9

**Naturschieferplatte „STARTER“**

natural slate tray  
bandeja de pizarra natural  
plat ardoise naturelle



	cm	mm
00937	20 x 10	6 - 9



00969

**Naturschieferplatte**

natural slate tray  
bandeja de pizarra natural  
plat ardoise naturelle



	Ø cm	mm
00968	22	6 - 9
00969	28	6 - 9
00998	33	6 - 9
00999	38	6 - 9



Präsentationsmöglichkeit  
presentation example

**Tortenplatte / Servierplatte**

cake stand  
soporte para pastel  
présentoir à gâteaux

**drehbar**  
rotatable  
giratorio  
rotatif



	Ø cm	↑ cm	mm
00975	32	2,5	6 - 9



drehbare Servierplatte  
rotatable cake stand

**Rolltop-Set**

rolltop set  
rolltop set  
rolltop set

3-teilig: • 1 Edelstahltablett Ø 38 cm  
• 1 Naturschieferplatte Ø 33 cm  
• 1 Rolltophaube Ø 38 cm

3 pcs.: • 1 stainless steel tray Ø 38 cm  
• 1 natural slate tray Ø 33 cm  
• 1 rolltop cover Ø 38 cm

set de 3: • 1 bandeja de acero inoxidable Ø 38 cm  
• 1 bandeja de pizarra natural Ø 33 cm  
• 1 campana abatible Ø 38 cm

set de 3: • 1 plateau en acier inox 38 cm  
• 1 plateau ardoise naturelle 33 cm  
• 1 cloche basculante 38 cm



	Ø cm	↑ cm
01000	38	24



**3-stufige Etagère**

3-tier tray  
bandeja con tres alturas  
étagère carré 3 hauteurs

**Naturschiefer, Akazienholz**

natural slate tray, wood akazie  
bandeja de pizarra natural, madera de acacia  
plateau ardoise naturelle, bois d'acacia



	Ø cm	↑ cm	✱ mm
00960	30 / 25 / 20	34	6 - 9

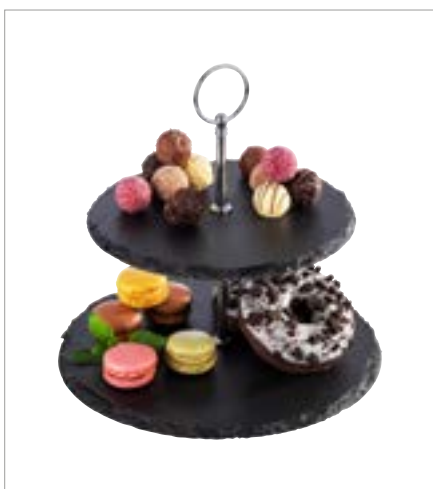

**2-stufige Etagère**

2-tier tray  
bandeja dos alturas  
étagère carré 2 hauteurs

**Naturschiefer**

natural slate tray  
bandeja de pizarra natural  
plateau ardoise naturelle



	Ø cm	↑ cm	✱ mm
00989	25 / 20	24	6 - 9



**Naturschieferplatte**

natural slate tray  
bandeja de pizarra natural  
plateau ardoise naturelle

**2-teilig: Naturschieferplatte mit Glashaube**

2 pcs.: natural slate tray with glass cover  
set de 2: bandeja de pizarra natural con tapa de cristal  
set de 2: plateau ardoise naturelle avec cloche en verre

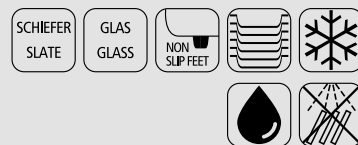

	Ø cm	↑ cm	✱ mm
00984	10,5	8	6 - 9



**Naturschieferplatten, 4er Set**

natural slate tray, 4 pcs.  
bandeja pizarra natural, set de 4  
plateau ardoise naturelle, set de 4



	cm	✱ mm	pcs.
00997	10 x 10	6 - 9	4



NEW

## SQUARE



NEW



00758 GN 1/1

11075

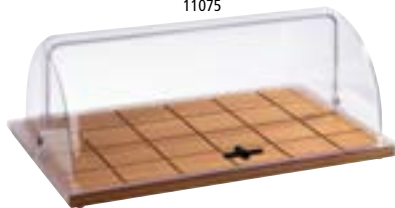

## GN 1/1 Buffetbrett „SQUARE“

GN 1/1 buffet board  
GN 1/1 tabla de buffet  
GN 1/1 planche de buffet

aus geöltem Eichenholz  
made of oiled oak wood  
de madera de roble aceitada  
en bois de chêne huilé



	cm	↑ cm	GN
00758	53,0 x 32,5	2,5	1/1

passende Haube / suitable cover / campana adecuada / cloche appropriée

	cm	↑ cm	GN
11075	53,0 x 32,5	19	1/1



Haube fixiert sich auf dem Brett, rutschfest  
cover fixes itself on the board, non-slip

NEW



00759 GN 1/2

11073



## GN 1/2 Buffetbrett „SQUARE“

GN 1/2 buffet board  
GN 1/2 tabla de buffet  
GN 1/2 planche de buffet

aus geöltem Eichenholz  
made of oiled oak wood  
de madera de roble aceitada  
en bois de chêne huilé



	cm	↑ cm	GN
00759	32,5 x 26,5	2,5	1/2

passende Haube / suitable cover / campana adecuada / cloche appropriée

	cm	↑ cm	GN
11073	33 x 28	17	1/2



Haube fixiert sich auf dem Brett, rutschfest  
cover fixes itself on the board, non-slip



**GN 2/4 Buffetbrett „SQUARE“**

GN 2/4 buffet board  
GN 2/4 tabla de buffet  
GN 2/4 planche de buffet

aus geöltem Eichenholz  
made of oiled oak wood  
de madera de roble aceitada  
en bois de chêne huilé



	cm	↑ cm	GN
00760	53,0 x 16,2	2,5	2/4



Präsentationsmöglichkeit  
presentation example

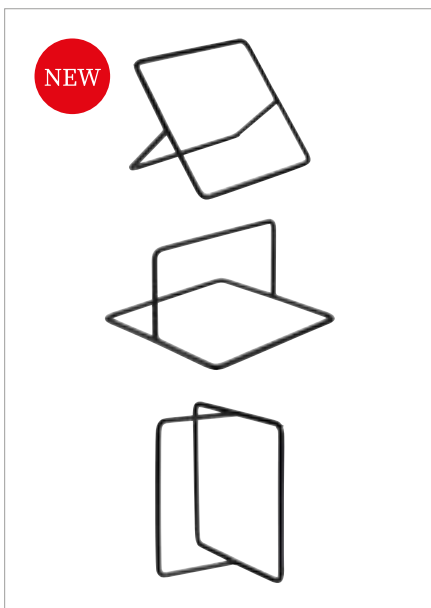

**Buffetständer „SQUARE“**

buffet stand  
soporte para buffet  
présentoir buffet

Metall, mit schwarzer Antirutschbeschichtung  
metal, with black anti-slide coating  
metal, con revestimiento antideslizante negro  
métal, avec revêtement antidérapant noir



	cm	↑ cm
33305	12 x 12	7



Präsentationsmöglichkeit | presentation example



**Buffetbrett**

buffet board  
tabla de buffet  
planche de buffet

für Karaffen, mit 3 Einsätzen Ø 11 cm aus Kunstleder, aus geöltem Eichenholz  
for carafes, with 3 leatherette inserts Ø 11 cm, made of oiled oak wood  
para jarras, con 3 inserciones de imitación de cuero Ø 11 cm, de madera de roble aceitada  
pour pichets, avec 3 inserts en similicuir Ø 11 cm, en bois de chêne huilé



	cm	↑ cm	Farbe / Colour
11705	47 x 19	2	natural oak
11706	47 x 19	2	dark oak

passende Karaffe / suitable carafe / jarra a juego / pichet approprié

	Ø cm	↑ cm	ltr.
10690	9,5	31	1,0

6 Einsätze aus Kunstleder / 6 leatherette inserts / 6 inserciones de imitación de cuero / 6 inserts en similicuir

	Ø cm	Farbe / Colour	pcs.
35716	11	anthracite	6



Kunstledereinsatz herausnehmbar  
removable leatherette insert

## SERVING BOARDS



NEW

**Servierbrett**

serving board  
tabla de servir  
planche de service

**aus geöltem Akazienholz**

made of oiled acacia wood  
de madera de acacia aceitada  
en bois d'acacia huilé



	cm	↑ cm
00793	25 x 17	1,5

NEW

**Servierbrett**

serving board  
tabla de servir  
planche de service

**aus geöltem Akazienholz**

made of oiled acacia wood  
de madera de acacia aceitada  
en bois d'acacia huilé



	cm	↑ cm
00792	37 x 8	2



**Präsentationsmöglichkeit**  
presentation example

NEW

**Servierschale**

serving bowl  
cuenca de servir  
bol de service

**aus geöltem Akazienholz**

made of oiled acacia wood  
de madera de acacia aceitada  
en bois d'acacia huilé



	cm	↑ cm
00790	16,5 x 9	2
00791	23,5 x 13	2

## SERVING BOARDS | WOOD



**Servierbrett**  
serving board  
tabla de servir  
planche de service



**2-teilig: 1 Holzbrett aus Akazienholz + 1 Naturschieferplatte**

2 pcs.: 1 wood board made of acacia wood + 1 natural slate tray  
set de 2: 1 tabla de madera de acacia + 1 pizarra natural  
set de 2: 1 planche en bois d'acacia + 1 ardoise naturelle

	cm	↑ cm
00814	28 x 17,5	2



**Servierbrett**  
serving board  
tabla de servir  
planche de service



**2-teilig: 1 Holzbrett aus Akazienholz + 1 Naturschieferplatte**

2 pcs.: 1 wood board made of acacia wood + 1 natural slate tray  
set de 2: 1 tabla de madera de acacia + 1 pizarra natural  
set de 2: 1 planche en bois d'acacia + 1 ardoise naturelle

	cm	↑ cm	Griff / handle cm
00810	26 x 18	2	8
00811	33 x 20	2	8
00812	40 x 15	2	5
00813	43 x 12	2	12

**Präsentationsmöglichkeit**  
presentation example



**mit Hängeloch Ø 2 cm / with a handle-hole Ø 2 cm**



**Servierbrett**  
serving board  
tabla de servir  
planche de service



**Servierbrett aus geöltem Akazienholz**

serving board made of oiled acacia wood  
tabla de servir de madera de acacia aceitada  
planche en bois avec plateau en bois d'acacia huilé

	cm	↑ cm
00897	30 x 15	2
00898	30 x 18	2
00899	35 x 25	2





**Servierbrett „SHARING“**

serving board  
tabla de servir  
planche de service



**Servierbrett aus geöltem Akazienholz**

serving board made of oiled acacia wood  
tabla de servir de madera de acacia aceitada  
planche en bois d'acacia huilé

	cm	↑ cm	Griff / handle cm
00887	51,5 x 18	1,5	8,5



**Servierbrett „AKAZIE-SCHIEFER“**

serving board  
tabla de servir  
planche de service



raffiniertes, rustikales Servierbrett aus Akazienholz,  
ausgestattet mit einem Naturschieferstreifen zur Kennzeichnung

wood with slate, markable  
madera con pizarra, se puede marcar  
bois avec ardoise, on peut mettre une inscription

	cm	↑ cm	Griff / handle cm
00867	30,5 x 13	1,5	10
00868	36,5 x 15	1,5	12
00869	42,0 x 18	1,5	14



**Servierbrett „OLIVE“**

serving board  
tabla de servir en madera de olivo  
planche de service en bois d'olivier



aus geöltem Olivenholz, mit 19 mm Aufhäng Bohrung, naturbe-  
dingte Abweichung in Form, Maserung und Größe

oiled olive wood, natural deviation in shape, grain and size  
de madera de olivo aceitada, diferencias naturales posibles en  
forma, grano y tamaño

en bois d'olivier huilé, éventuelles différences naturelles de forme,  
de grain et de taille

	cm	↑ cm	Griff / handle cm
00870	25 x 17,0	1,5	
00871	30 x 20,5	2,0	
00873	40 x 15,0	1,5	11
00874	44 x 20,0	2,0	12
00875	19 x 12,5	1,5	6
00876	25 x 16,0	1,5	8
00877	31 x 20,0	1,5	9



**Servierbrett „OLIVE“**

serving board  
tabla de servir  
planche de service



aus geöltem Olivenholz, naturbedingte Abweichung in Form, Maserung und Größe

oiled olive wood, natural deviation in shape, grain and size

de madera de olivo aceitada, diferencias naturales posibles en forma, grano y tamaño

en bois d'olivier huilé, éventuelles différences naturelles de forme, de grain et de taille

	cm	↑ cm
00905	25,5 x 16,5	1,5
00906	35,0 x 20,5	1,5



**Servier- und Tortenplatte**

cake stand  
porta pasteles  
présentoir à gâteaux



Eichenholz geölt, mit Safrille

oak wood oiled, with juice groove

madera de roble aceitada, con ranura para líquidos

bois de chêne huilé, avec rigole

	Ø cm	↑ cm
00818	32	2,0



Präsentationsmöglichkeit  
presentation example

passende Hauben / cover / campana / cloche



	Ø cm	↑ cm
06510	30	11,5
06512	30	11,5
06520	30	22



**Servierbrett „OAK“**

serving board  
tabla de servir  
planche de service



aus geöltem Eichenholz, Safrille, Ø 9,5 cm Aussparung

made of oiled oak, with juice groove, with hole Ø 9.5 cm

de madera de roble aceitada, con ranura para líquidos, con agujero Ø 9,5 cm

en bois chêne huilé, avec rigole, avec trou Ø 9,5 cm

	cm	↑ cm
00808	37 x 25	2



mit Safrille  
with juice groove

# SERVING BOARD



Ø 6 cm



82316

beidseitig nutzbar  
double-sided usable

## Servierbrett

serving board  
tabla de servir  
planche de service

aus geöltem Eichenholz, mit 8 Vertiefungen Ø 6 cm

made of oiled oak wood, with 8 notches Ø 6 cm

de madera de roble aceitada con 8 ranuras Ø 6 cm

en bois de chêne huilé avec 8 encoches Ø 6 cm



	cm	↑ cm
00809	100 x 14	1,5

Präsentationsmöglichkeit  
presentation example



40636  
Henkelbecher  
beaker

mit Hängeloch Ø 2 cm / with a handle-hole Ø 2 cm



mit Hängeloch Ø 1,5 cm  
with a handle-hole Ø 1,5 cm



Präsentationsmöglichkeit  
presentation example

## Servierbrett

serving board  
tabla de servir  
planche de service

aus geöltem Buchenholz mit Daumenmulde auf einer Seite

made of oiled beech wood with thumb recess on one side

de madera de haya aceitada con hueco para el pulgar en un lado

en bois de hêtre huilé avec encoche pour le pouce sur un côté



	cm	↑ cm
00817	60 x 19,5	2



Eiche, das widerstandsfähigste europäische Holz, ist seit jeher Ausdruck von Qualität, Kraft und Energie. Eichen werden uralt und riesengroß, sind unvergleichlich stark und standfest.

Oak, the most resistant European wood, has always been an expression of quality, strength and energy. Oaks grow to be ancient and huge, are incomparably strong and stable.

El roble, la madera europea más resistente, siempre ha sido expresión de calidad, fuerza y energía. Los robles llegan a ser antiguos y gigantes, son incomparablemente fuertes y estables.

Le chêne, le bois européen le plus résistant, est depuis toujours l'expression de la qualité, de la force et de l'énergie. Les chênes deviennent très vieux et gigantesques, ils sont incomparablement forts et stables.



**Servierbrett „SIMPLY WOOD“**

servicing board  
tabla de servir  
planche de service



**Eichenholz geölt, mit Aufhängeloch Ø 1,5 cm, mit Lederband**

oak wood oiled, with handle hole Ø 1,5 cm, with leather strap  
madera de roble aceitada, con agujero para colgar Ø 1,5 cm, con correa de cuero  
bois de chêne huilé, avec trou de suspension Ø 1,5 cm, avec ruban en cuir

	cm	↑ cm	→ Griff / handle
00750	20 x 20	2	8
00751	27 x 17	2	8
00752	32 x 22	2	8



mit Lederband  
with leather strap

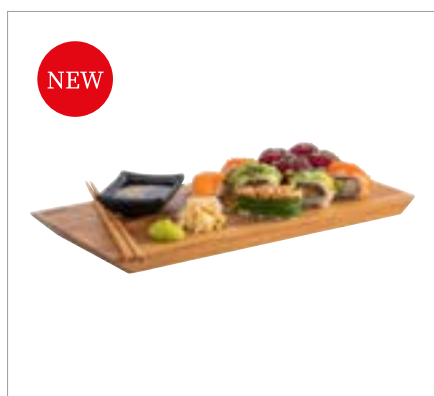

**Tablett / Sushiboard „SIMPLY WOOD“**

tray / sushiboard  
bandeja para sushi  
plateau sushi

aus geöltem Eichenholz  
made of oiled oak wood  
de madera de roble aceitada  
en bois de chêne huilé



	cm	↑ cm
00753	35 x 17	2

**GN 1/3 Servierbrett „SIMPLY WOOD“**

GN 1/3 serving board  
GN 1/3 tabla de servir  
GN 1/3 planche de service



**Eichenholz geölt, mit Vertiefung Ø 4 cm, mit Safrinne**

oak wood oiled, with notch Ø 4 cm, with juice groove  
madera de roble aceitada, con ranura Ø 4 cm, con ranura para líquidos  
bois de chêne huilé, mit avec encoche Ø 4 cm, avec rigole

	cm	↑ cm	GN
00754	32,5 x 17,6	2	1/3

**Servierbrett**

serving board  
tabla de servir  
planche de service



**Eichenholz, geölt, 2 Vertiefungen Ø 4,5 cm, 1 Vertiefung Ø 3 cm, mit 2 Griffmulden**

oak wood oiled, 2 notches Ø 4,5 cm, 1 notch Ø 3 cm, with 2 recessed handles  
madera de roble aceitada, 2 ranuras Ø 4,5 cm, 1 ranura Ø 3 cm, con 2 asas empotradas  
bois de chêne huilé, 2 encoches Ø 4,5 cm, 1 encoche Ø 3 cm, avec 2 poignées encastrées

	cm	↑ cm
00835	15 x 9	1,5

passende Gläser / fitting glasses / tarros de vidrio adecuados / verrines appropriées

	Ø cm	↑ cm	ltr.	pcs
82350	5,5	6	0,075	12

**Servierbrett „PIZZA“**

serving board  
tabla de servir  
planche de service



**Eichenholz geölt, mit Safrinne, mit 2 Griffmulden**

oak wood oiled, with juice groove, with 2 recessed handles  
madera de roble aceitada, con ranura para líquidos, con 2 asas empotradas  
bois de chêne huilé, avec rigole, avec 2 poignées encastrées

	Ø cm	↑ cm
00755	24	2
00756	29	2
00757	34	2



mit 2 Griffmulden an der Unterseite  
with 2 recessed handles on the bottom

**Serviervablett**

serving tray  
bandeja para servir  
plateau de service



**aus geöltem Eichenholz, mit 2 Griffmulden**

made of oiled oak wood, with 2 recessed handles  
de madera de roble aceitada, con 2 asas empotradas  
en bois de chêne huilé, avec 2 poignées encastrées

	cm	↑ cm
00761	45 x 35	6



**Servierbrett „GENUSSPALETTE“**

serving board  
tabla de servir  
planche de service

**Genusspalette im Kleinformat, Birke**  
mini serving palett, birch  
tabla de servir, formato pequeño, abedul  
planche de service, petit format, bouleau



	cm	↑ cm
00880	20 x 12	3
00881	30 x 20	3
00882	40 x 15	3



**Table Caddy „OLIVE“**

table barrel  
caddy de mesa  
caddy de table

**aus geöltem Olivenholz**  
oiled olive wood  
de madera de olivo aceitada  
en bois d'olivier huilé



	cm	↑ cm
01016	22 x 15	6
01017	25 x 18	6



**Allzweckstreuer, 12 er Set / shaker, 12 pcs. / dosificador, set de 12 / salières/poivrières set de 12**

	cm	↑ cm	ltr.
40504	4 x 4	10	0,07

**passende Brottasche / suitable bread basket / panera a juego / corbeilla assortie**

	cm	↑ cm	Farbe / Colour
30356	12 x 11,5	11,5	■

**passende Mühlen / suitable mills/ molinos de ajuste / moulins assortis**

	ø cm	↑ cm
40555	6	15,5
40556	6	15,5



**Wachspapier „SNACKHOLDER“**

greaseproof paper squares  
papel alimenticio  
papier alimentaire



	cm	pcs.	Motiv: Zeitung
40670	42 x 25	500	



01010

0,15 ltr.



01011

0,25 ltr.



01012

0,50 ltr.

**Schale „OLIVE“**bowl  
cuenco  
bol

aus geöltem Olivenholz, naturbedingte Abweichung in Form, Maserung und Größe

oiled olive wood, natural deviation in shape, grain and size

de madera de olivo aceitada, diferencias naturales posibles en forma, grano y tamaño  
en bois d'olivier huilé, éventuelles différences naturelles de forme, de grain et de taille

	Ø cm	↑ cm	ltr.
01010	10,0	4,0	0,15
01011	12,5	4,5	0,25
01012	15,0	6,0	0,50

3 Größen ineinander  
3 sizes in each other

00843

0,05 ltr.



00844

0,10 ltr.

**Schale „OLIVE“**bowl  
cuenco  
bol

aus geöltem Olivenholz, naturbedingte Abweichung in Form, Maserung und Größe

oiled olive wood, natural deviation in shape, grain and size

de madera de olivo aceitada, diferencias naturales posibles en forma, grano y tamaño  
en bois d'olivier huilé, éventuelles différences naturelles de forme, de grain et de taille

	cm	↑ cm	ltr.
00843	12,0 x 7,5	2,5	0,05
00844	16,5 x 9,5	2,5	0,10



00907

0,20 ltr.



00908

0,30 ltr.



01023

0,40 ltr.

**Schale „OLIVE“**bowl  
cuenco  
bol

aus geöltem Olivenholz, naturbedingte Abweichung in Form, Maserung und Größe

oiled olive wood, natural deviation in shape, grain and size

de madera de olivo aceitada, diferencias naturales posibles en forma, grano y tamaño  
en bois d'olivier huilé, éventuelles différences naturelles de forme, de grain et de taille

	cm	↑ cm	ltr.
00907	13 x 8	6,5	0,2
00908	16 x 9	7,0	0,3
01023	25 x 8,5	7,5	0,4



**Schale „OLIVE“**

bowl  
cuenco  
bol



aus geöltem Olivenholz  
oiled olive wood  
de madera de olivo aceitada  
en bois d'olivier huilé

	cm	↑ cm	ltr.
01013	7,5 x 7,5	2,5	0,05
01014	17,5 x 8,5	2,5	0,15
01015	26,5 x 11,5	5,0	0,60



Servierbeispiel - Lieferung ohne Gläser  
delivery without glasses

**Holzbox „TABLE“**

woodbox  
caja madera  
base bois



Akazienholz, 3 Fächer (6,5 x 6,5 cm) / acacia wood, 3 compartments (6,5 x 6,5 cm) / madera de acacia, 3 compartimentos (6,5 x 6,5 cm) / bois d'acacia, 3 compartiments (6,5 x 6,5 cm)

	cm	↑ cm	inner size cm
11727	23,5 x 8,5	4,5	6,5 x 6,5 je Fach / each compartment



Servierbeispiel - Lieferung ohne Gläser  
delivery without glasses

**Servierbrett „NARROW I“**

servicing board  
tabla de servir  
planche de service



Akazienholz, mit 3 Vertiefungen Ø 4 cm / acacia wood, with 3 notches Ø 4 cm  
madera de acacia, con 3 ranuras Ø 4 cm / bois d'acacia, avec 3 encoches Ø 4 cm

	cm	↑ cm
00864	22 x 8	1,5

passende Schälchen / fitting bowls / cuencos adecuados / bols appropriés

	Ø cm	↑ cm	ltr.	
82359	5	3,5	0,035	glass / 12 pcs
82350	6	5,5	0,08	glass / 12 pcs
40685	6	3,0	0,05	stainless steel



Servierbeispiel - Lieferung ohne Schälchen  
delivery without bowls

**Servierbrett „NARROW II“**

servicing board  
tabla de servir  
planche de service



Akazienholz, mit 3 Vertiefungen Ø 6 cm  
acacia wood, with 3 notches Ø 6 cm  
madera de acacia, con 3 ranuras Ø 6 cm  
bois d'acacia, avec 3 encoches Ø 6 cm

	cm	↑ cm
00878	31 x 11	2

passende Schälchen / fitting bowls / cuencos adecuados / bols appropriés

	Ø cm	↑ cm	ltr.	
40686	8	4,5	0,17	stainless steel



# BUFFET BOARDS „PROFI“



06512

Ø 33 cm

00805



06521

Ø 39 cm

00816



00807



00806

11016  
GN 1/1

00806

## Buffetbrett „PROFI“

buffet board  
tabla de buffet  
planche de buffet

aus geöltem Eichenholz, Safrinne, mit Antirutschfüßchen

made of oiled oak, with juice groove and non-slip feet

de madera de roble aceitada, con ranura para líquidos y pies antideslizantes

en bois chêne huilé, avec rigole et pieds antidérapants



	Ø cm	↑ cm
00805	33	4,5
00816	39	4,5

## Frischhaltehaube / cover / campana / cloche



	Ø cm	↑ cm	fits to
06512	30	11,5	00805

## Frischhaltehaube / cover / campana / cloche



	Ø cm	↑ cm	fits to
06519	21	17	00815
06520	30	22	00805
06521	36	27	00816

## Buffetbrett „PROFI“

buffet board  
tabla de buffet  
planche de buffet

aus geöltem Eichenholz, Safrinne, mit Antirutschfüßchen

made of oiled oak, with juice groove and non-slip feet

de madera de roble aceitada, con ranura para líquidos y pies antideslizantes

en bois chêne huilé, avec rigole et pieds antidérapants



	cm	↑ cm
00807	38 x 32,0	4,5
00806	58 x 37,5	4,5

## Rolltophaube / rolltop cover / campana rolltop / cloche rolltop



	Ø cm	↑ cm	fits to	GN
11016	53,0 x 32,5	19	00806	1/1



# CUTTING BOARDS



## Brottschneidebrett

cutting board  
tabla de cortar  
planche à découper

Walnussholz / walnut wood / mader de nogal / bois de noyer



	cm	↑ cm	GN
00911	35,4 x 32,5	3,5	2/3



praktisches Krümelfach  
practical crump shelf



praktisches Krümelfach  
practical crump shelf

## Brottschneidebrett „LETTER“

cutting board  
tabla de cortar  
planche à découper

Akazienholz / acacia wood / mader de acacia / bois d'acacia



	cm	↑ cm	
00886	48 x 34	3,5	



praktisches Krümelfach  
practical crump shelf



00885

## Brottschneidebrett

cutting board  
tabla de cortar  
planche à découper

Akazienholz / acacia wood / mader de acacia / bois d'acacia



	cm	↑ cm	GN
00883	47,5 x 32,0	2	
00884	53,0 x 32,5	2	1/1
00885	60,0 x 40,0	2	



praktisches Krümelfach  
practical crump shelf



## Brottschneidebrett

cutting board  
tabla de cortar  
planche à découper

Rubberwood / rubberwood / mader de caucho / bois d'hévéa



	cm	↑ cm	GN
00955	47,5 x 32,0	2	
00956	53,0 x 32,5	2	1/1
00957	60,0 x 40,0	2	



praktisches Krümelfach  
practical crump shelf

**Serviertablett „HAPPY HOUR“**

tray  
bandeja  
plateau

rutschfeste Oberfläche  
non-slip surface  
superficie antideslizante  
surface antidérapante



	Ø cm	↑ cm	Farbe / Colour
00510	32	1,5	■
00511	38	1,5	■
00515	43	1,5	■

**Bierglasträger „NON SLIP“**

beer rack  
bandeja para cerveza  
porte verre à bière

rutschfeste Oberfläche  
non-slip surface  
superficie antideslizante  
surface antidérapante



	Ø cm	↑ cm	Farbe / Colour
00500	36	3,5	■
00506	28 x 20	1,5	■

**Tablett „GASTRO“**

tray  
bandeja  
plateau

rutschfeste Oberfläche  
non-slip surface  
superficie antideslizante  
surface antidérapante



	Ø cm	↑ cm	Farbe / Colour
00547	27,5	2	■
00548	35,5	2	■
00549	40,5	2	■

**Tablett „BISTRO“**

tray  
bandeja  
plateau

rutschfest, mit 2 Griffmulden und Stapelrand  
non-slip, two open handles, stackable edge  
antideslizante, con 2 asas y borde apilable  
antidérapant, avec 2 poignées et bord d'empilage



	Ø cm	↑ cm	Farbe / Colour
84045	35,5	4,5	■

## TRAYS



### Serviertablett „NON SLIP“

tray non-slip  
bandeja  
plateau

**rutschfeste Oberfläche**  
non-slip surface  
superficie antideslizante  
surface antidérapante



	cm	↑ cm	GN	Farbe / Colour
00502	53,0 x 32,5	1,5	1/1	■
00508	46,0 x 36,0	2,0		■



### Tablett

tray  
bandeja  
plateau

**rutschfest, Holzdekor-Laminat**  
non-slip, coated wood  
antideslizante, decoración madera láminae  
antidérapant, décor bois laminé



	cm	↑ cm
00524	43,5 x 31,5	1,5
00525	52,0 x 39,0	1,5
00526	60,5 x 42,5	1,5



### Tablett

tray  
bandeja  
plateau

**rutschfest, Mahagonifurnier**  
non-slip, woodform, mahogany  
antideslizante, revestimento de caoba  
antidérapant, placage en acajou



	Ø cm	↑ cm	
00528	31,0	3,5	hoher Rand
00529	35,5	3,5	hoher Rand



### Tablett

tray  
bandeja  
plateau

**rutschfest, Holzdekor-Laminat**  
non-slip, coated wood  
antideslizante, limando decoracion maderas  
antidérapant, décor bois stratifié



	cm	↑ cm
00521	26 x 20	1
00522	29 x 21	1

# FAST FOOD TRAYS



**Fast Food-Tablett**  
 snack tray  
 bandeja autoservicio y snacks  
 plateau self-service et snacks



00535



00536



00537



00538



00534



00539

	cm	↑ cm	GN	Farbe / Colour
00530	35 x 27,0	2		
00535	41 x 30,5	2		
00540	45 x 35,5	2		
00552	53 x 32,5	2	1/1	

	cm	↑ cm	GN	Farbe / Colour
00531	35 x 27,0	2		
00536	41 x 30,5	2		
00541	45 x 35,5	2		
00553	53 x 32,5	2	1/1	

	cm	↑ cm	GN	Farbe / Colour
00532	35 x 27,0	2		
00537	41 x 30,5	2		
00542	45 x 35,5	2		
00554	53 x 32,5	2	1/1	

	cm	↑ cm	GN	Farbe / Colour
00533	35 x 27,0	2		
00538	41 x 30,5	2		
00543	45 x 35,5	2		
00555	53 x 32,5	2	1/1	

	cm	↑ cm	GN	Farbe / Colour
00534	35 x 27,0	2		

	cm	↑ cm	GN	Farbe / Colour
00539	35 x 27,0	2		



stapelbar  
 stackable

# CAKE STANDS



**Servier- und Tortenplatte „CASUAL“**  
 cake plate  
 porta pasteles  
 présentoir à gâteaux



	Ø cm	↑ cm
83890	31	8
83891	31	16
	cm	↑ cm
83892	31 x 31	8
83893	31 x 31	16



**Servier- und Tortenplatte**  
 cake stand  
 porta pasteles  
 présentoir à gâteaux



**Rand fixiert die Haube, mit Antirutschfüßchen**

carved edge fixes the cover, with non-slip feet

ranura para fijar bien la campana, con pies antideslizantes

bord rainuré pour maintenir ferme la cloche, avec pieds antidérapants



	Ø cm	↑ cm	Farbe / Colour	fits to cover
00468	31	3,5	White	06520
00469	31	3,5	Black	06520



**Servier- und Tortenplatte**  
 cake stand  
 porta pasteles  
 présentoir à gâteaux



**Eichenholz geölt, mit Safrin**

oak wood oiled, with juice groove

madera de roble aceitada, con ranura para líquidos

bois de chêne huilé, avec rigole

	Ø cm	↑ cm
00818	32	2,0

**passende Hauben / suitable for covers / campanas adecuadas / cloches appropriées**

	Ø cm	↑ cm
06520	30	22
06510	30	11,5

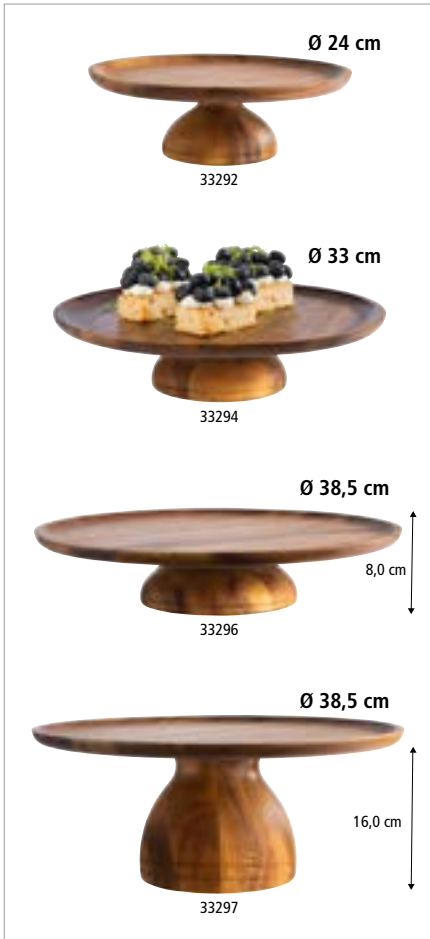

**Servier- und Tortenplatte „ACACIA“**

cake stand  
porta pasteles  
présentoir à gâteaux

**Akazienholz geölt, möbelschonende Unterseite**  
acacia wood oiled, furniture-friendly underside  
madera de acacia aceitada, con base anti rayaduras  
bois d'acacia huilé, avec revêtement antirayures



	Ø cm	↑ cm
33292	24,0	8
33293	24,0	16
33294	33,0	8
33295	33,0	16
33296	38,5	8
33297	38,5	16

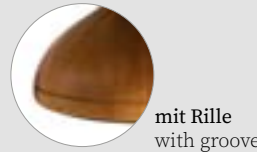

mit Rille  
with groove

**Frischhaltehaube / cover / campana / cloche**



	Ø cm	↑ cm	fits to
06519	21	17	33292, 33293
06520	30	22	33294, 33295
06521	36	27	33296, 33297



drehbar  
rotating

**Servier- und Tortenplatte**

cake stand  
porta pasteles  
présentoir à gâteaux

**matt poliert, drehbar, möbelschonende Unterseite**  
matt polished, rotating, furniture-friendly underside  
pulido mate, giratoria, con base anti rayaduras  
poli mat, pivotant, avec revêtement antirayures



	Ø cm	↑ cm
00463	30,5	9



**Servier- und Tortenplatte**

cake stand  
porta pasteles  
présentoir à gâteaux

**matt poliert / matt polished / pulido mate / poli mat**



	Ø cm	↑ cm
00046	31	3



**Auslagen- / Kuchenplatte**

display / cake plate  
expositor / plato para tartas  
présentoir / assiette à gâteau

**ideale Größe für Baumkuchen / Stollen**  
ideal size for Baumkuchen / Stollen  
tamaño ideal para Baumkuchen / Stollen  
taille idéale pour Baumkuchen / Stollen



	cm	↑ cm
00047	40 x 16	2,5

# SUPER DOME



## Frischhaltehaube „SUPER DOME“

cover  
campana  
cloche



schwere, glasklare Qualität  
stable, crystal clear quality  
muy resistente y transparencia cristalina  
haute résistance et transparence

	Ø cm	↑ cm
06525	30	40

passende Servier-/Tortenplatten / suitable cake stands / porta pasteles compatibles / présentoirs à gâteaux compatibles

	Ø cm	↑ cm	fits to	Farbe / Colour
00468	31,0	3,5	06525	
33294	33,0	8,0	06525	
33295	33,0	16,0	06525	

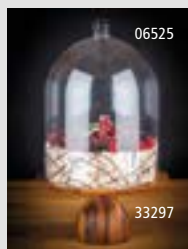

Präsentationsmöglichkeiten  
presentation examples



## Frischhaltehaube

cover  
campana  
cloche



schwere, glasklare Qualität  
stable, crystal clear quality  
calidad estable y transparencia cristalina  
qualité stable et clarté cristalline

	Ø cm	↑ cm	fits to
06519	21	17	84941, 84942
06520	30	22	85034, 84177, 83891, 83890, 83884, 998, 975, 469, 468, 463, 462, 46
06521	36	27	84945, 84946





**Besteckbehälter**  
cutlery box  
recipiente para cubiertos  
récipient pour couverts



**Akazienholz, 4 Fächer (26 x 11,5 cm)**  
acacia wood, 4 compartments (26 x 11,5 cm)  
madera de acacia, 4 compartimentos (26 x 11,5 cm)  
bois d'acacia, 4 compartiments (26 x 11,5 cm)

	cm	↑ cm	Farbe / Colour	
11952	51 x 28	13		nature
11951	51 x 28	13		vintage white



**Besteckbehälter mit Deckel**  
cutlery box with cover  
caja de cubiertos con tapa  
range-couverts avec couvercle



**Akazienholz, 4 Fächer (26 x 11,5 cm), mit Deckel**  
acacia wood, 4 compartments (26 x 11,5 cm), with cover  
madera de acacia, 4 compartimentos (26 x 11,5 cm), con tapa  
bois d'acacia, 4 compartiments (26 x 11,5 cm), avec couvercle

	cm	↑ cm	Farbe / Colour	
11949	51 x 28	14,5		nature
11948	51 x 28	14,5		vintage white



**GN 1/1 Besteckbehälter**  
GN 1/1 dispenser GN  
GN 1/1 dispensador de cubiertos  
GN 1/1 bac à couverts



**in Handarbeit geflochten, 4 Mulden, Kunststoff-Geflecht, Drahtgestell, braun-schwarz**  
hand-woven, 4 troughs, plastic wickerwork, wire frame, brown-black  
cesta trensada a mano, 4 compartimentos, mimbre de plástico, marco de alambre, marrón-negro  
corbeille tressée à main, 4 compartiments, plastique tressé, armature en fil métallique, brun-noir

	cm	↑ cm	Farbe / Colour	GN
11966	53 x 32,5	9		1/1



**GN 1/1 Besteckbehälter**  
GN 1/1 cutlery dispenser  
GN 1/1 dispensador de cubiertos  
GN 1/1 bac à couverts



**4 Mulden, Kunststoff-Geflecht, Drahtgestell, beige**  
4 troughs, plastic wickerwork, wire frame, beige  
4 compartimentos, mimbre de plástico, marco de alambre, beige  
4 compartiments, plastique tressé, structure métallique, beige

	cm	↑ cm	Farbe / Colour	GN
11965	53 x 32,5	10		1/1

## CUTLERY BOXES



### GN 1/1 Besteckbehälter

GN 1/1 cutlery bin  
GN 1/1 recipiente para cubiertos  
GN 1/1 récipients pour couverts



#### 4 Mulden

4 troughs  
4 compartimentos  
4 compartiments

	cm	↑ cm	Farbe / Colour	GN
11954	53 x 32,5	10	■	1/1
11955	53 x 32,5	10	■	1/1

#### 3 Mulden, 3 Köcher

3 troughs, 3 cutlery baskets  
3 compartimentos, 3 cestas para cubiertos  
3 compartiments, 3 corbeilles à couverts

	cm	↑ cm	Farbe / Colour	GN
11960	53 x 32,5	10	■	1/1



### Besteckbehälter

cutlery basket  
recipiente para cubiertos  
récipients pour couverts



#### 4 Löcher inklusive 4 Edelstahl Köcher

4 holes including 4 stainless baskets  
4 agujeros con 4 cestas de acero inoxidable  
4 trous avec 4 corbeilles en acier inox

	cm	↑ cm	Farbe / Colour
93321	27 x 27	15	■



### Besteckköcher

cutlery basket  
cesta para cubiertos  
corbeille à couverts



Polyethylen weiß / polyethylene white plastic / polietileno blanco / polyéthylène blanc

	Ø cm	↑ cm
11998	9,5	13,5

Edelstahl matt poliert / stainless steel matt polished / acero inoxidable pulido mate / acier inox poli mat

	Ø cm	↑ cm
11999	9,5	13,5



### Besteckkasten „INDUSTRIAL“

cutlery box  
caja para cubiertos  
boîte pour couverts



#### Metall, schwarz

metal, black  
metal, negro  
métal, noir

	cm	↑ cm	litr.
40676	23,0 x 15,5	13,0	2,4



# NAPKIN HOLDERS



## Serviettenhalter

napkin holder  
servilletero  
porte-serviettes

matt poliert / matt polished / pulido mate / poli mat



	cm	↑ cm
11730	17 x 17	5



## Serviettenhalter

napkin holder  
servilletero  
porte-serviettes

hochglanzpoliert, für Servietten mit 1/8 Falz, Füße mit rutsch- und kratzfesten Gummierung  
mirror polished, for napkins with 1/8 fold, feet with non-slip and scratch-resistant rubber coating

pulido brillante, para servilletas plegado 1/8, pies con revestimiento de goma antideslizante y anti rayaduras

poli brillant, pour serviettes pliage 1/8, pieds avec caoutchouc antidérapant et antirayures



	cm	↑ cm
11720	10 x 11,5	18,5



11767

## Serviettenhalter „HERO“

napkin holder  
servilletero  
porte-serviettes

für ca. 65 Cocktailservietten, inklusive Beschwerer

for approx. 65 cocktail napkins, including weight

para aprox. 65 servilletas cocktail, con barrita de contrapeso

pour environ 65 serviettes cocktail, avec barre de contrepoids



	cm	↑ cm
11767	14,5 x 14,5	10

für ca. 95 Servietten 1/4 Falz, inklusive Beschwerer

for approx. 95 napkins 1/4 fold, including weight

para aprox. 95 servilletas de plegado 1/4, con barrita de contrapeso

pour environ 95 serviettes pliage 1/4, avec barre de contrepoids

	cm	↑ cm
11768	18,5 x 18,5	14



11768



inklusive Beschwerer  
including weight

## NAPKIN HOLDERS

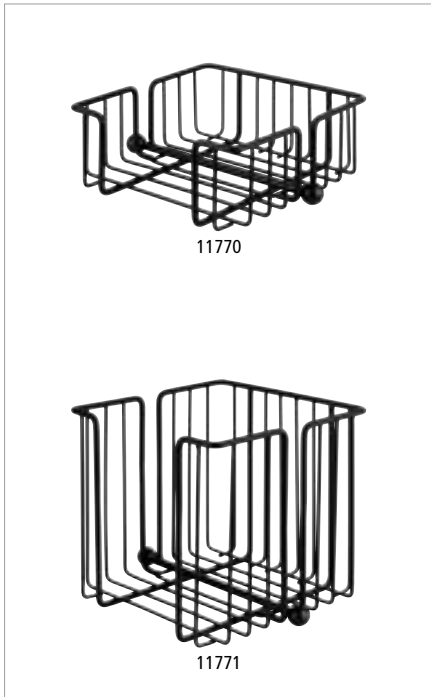

11770

11771

### Serviettenhalter „URBAN“

napkin holder  
servilletero  
porte-serviettes

für ca. 50 Servietten 1/4 Falz, inklusive Beschwerer

for approx. 50 napkins 1/4 fold, including weight  
para aprox. 50 servilletas de plegado 1/4, con barra de contrepeso  
pour environ 50 serviettes pliage 1/4, avec barre de contrepoids



cm                    ↑ cm

11770                    19 x 19                    7,5

für ca. 120 Servietten 1/4 Falz, inklusive Beschwerer

for approx. 120 napkins 1/4 fold, including weight  
para aprox. 120 servilletas de plegado 1/4, con barra de contrepeso  
pour environ 120 serviettes pliage 1/4, incl. barrie de contrepoids

cm                    ↑ cm

11771                    19 x 19                    18



inklusive Beschwerer  
including weight

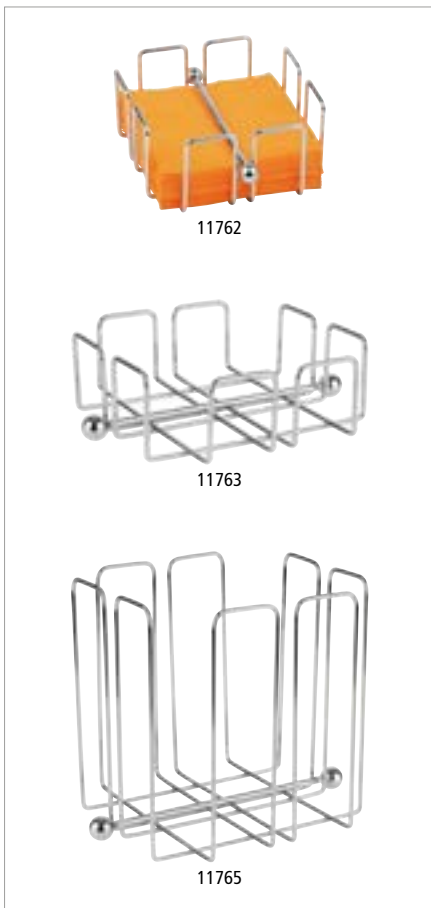

11762

11763

11765

### Serviettenhalter „WIRE“

napkin holder  
servilletero  
porte-serviettes

für ca. 50 Cocktailservietten, inklusive Beschwerer

for approx. 50 cocktail napkins, including weight  
para aprox. 50 servilletas cocktail, con barra de contrepeso  
pour environ 50 serviettes cocktail, avec barre de contrepoids



cm                    ↑ cm

11762                    14 x 14                    6,5

für 50 Servietten 1/4 Falz, inklusive Beschwerer

for 50 napkins 1/4 fold, including weight  
para 50 servilletas plegado 1/4, con barra de contrepeso  
pour 50 serviettes pliage 1/4, avec barre de contrepoids

cm                    ↑ cm

11763                    19 x 19                    6,5

für 150 Servietten 1/4 Falz, inklusive Beschwerer

for 150 napkins 1/4 fold, including weight  
para 150 servilletas plegado 1/4, con barra de contrepeso  
pour 150 serviettes pliage 1/4, avec barre de contrepoids

cm                    ↑ cm

11765                    19 x 19                    19,0



inklusive Beschwerer  
including weight



### Serviettenhalter

napkin holder  
servilletero  
porte-serviettes

möbelschonende Unterseite, für ca. 20 Servietten, matt poliert

furniture-friendly underside, for approx. 20 napkins, matt polished  
con base anti rayaduras, para aprox. 20 servilletas, pulido mate  
avec revêtement antirayures, pour environ 20 serviettes, poli mat



cm                    ↑ cm

11778                    17 x 3                    7



**Serviettenhalter**

napkin holder  
servilletero  
porte-serviettes



**möbelschonende Unterseite, für ca. 30 Servietten, matt poliert**  
furniture-friendly underside, for approx. 30 napkins, matt polished  
con base anti rayaduras, para aprox. 30 servilletas, pulido mate  
avec revêtement antirayures, pour environ 30 serviettes, poli mat

	cm	↑ cm
11780	15 x 4,5	12,5



**Serviettenhalter „ELEMENT“**

napkin holder  
servilletero  
porte-serviettes

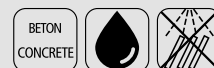

**aus Beton, für ca. 50 Servietten, möbelschonende Unterseite**  
concrete, for approx. 50 napkins, furniture-friendly underside  
hormigón, para aprox. 50 servilletas, con base anti rayaduras  
béton, pour environ 50 serviettes, avec revêtement antirayures

	cm	↑ cm
11781	16 x 7,5	10



**Table Caddy „ELEMENT“**

table caddy  
caddy de mesa  
caddy de table



**aus Beton, möbelschonende Unterseite**  
concrete, furniture-friendly underside  
hormigón, con base anti rayaduras  
béton, avec revêtement antirayures

	cm	↑ cm	inner size cm
11647	16,5 x 16	6,5	14,5 x 14



**Table Caddy „ELEMENT“**

table caddy  
caddy de mesa  
caddy de table



**Beton, möbelschonende Unterseite, 2 Löcher je 6,5 cm**  
concrete, furniture-friendly underside, 2 holes each 6.5 cm  
hormigón, con base anti rayaduras, 2 agujeros cada uno 6,5 cm  
béton, avec revêtement antirayures, 2 trous de 6,5 cm chacun

	cm	↑ cm	inner size cm
11648	23,5 x 16	6,5	14,5 x 14



# Buffet & Tableware Melamine



NERO.....	144	CIRCLE   LA VIDA.....	189
CANCUN.....	147	MARONE.....	190
LOOPS.....	148	DARK WAVE.....	193
MOON.....	150	ZEN.....	195
EMMA.....	152	SINUS.....	199
APS+.....	154	HALFTONE.....	200
ASIA+.....	155	APART   CASCADE.....	202
BLUE OCEAN.....	159	GLOBAL BUFFET.....	203
ARABESQUE.....	161	FLYING BUFFET.....	204
BAMBOO.....	163	FLOAT.....	205
STONE ART.....	164	PURE.....	207
AIKO.....	167	ENAMEL LOOK.....	211
ELEMENT.....	168	CASUAL.....	212
TIMBER.....	171	NATURAL COLLECTION....	214
OAK.....	172	BRÖTCHENSCHÜTTE.....	215
OAK LIGHT.....	173	CASUAL   SEAFOOD.....	216
GLAMOUR.....	174	BALANCE.....	217
CROCKER.....	175	CUTLERY REST.....	218
FRIDA.....	177	PARTY SPOON.....	219
SLATE.....	185	MINI.....	221
SLATE ROCK.....	187	GN CONTAINER.....	224
ZERO   DRIFTWOOD.....	188		



# NERO



## GN Tablett „NERO“

GN tray  
GN bandeja  
GN plateau



	cm	↑ cm	GN
85067	53,0 x 32,5	2,5	1/1
85068	32,5 x 26,5	2,5	1/2

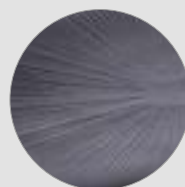

## Teller „NERO“

plate  
plato  
assiette



	Ø cm	↑ cm
85073 <span style="color: red;">NEW</span>	15	3
85063	21	3
85064	26	3
85065	33	3,5
85066	42	3,5

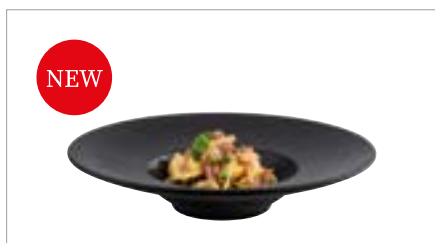

## Teller „NERO“

plate  
plato  
assiette



	Ø cm	↑ cm	ltr.
85098	29	6	0,3





85069 0,5 ltr.



85070 0,9 ltr.



85061 1,7 ltr.

Schale „NERO“  
bowl  
cuenco  
bol



	∅ cm	↑ cm	ltr.
85069	16	6,5	0,5
85070	19	8,0	0,9
85061	24	9,0	1,7

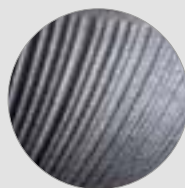

85060 0,8 ltr.



85062 2,2 ltr.

Schale „NERO“  
bowl  
cuenco  
bol



	∅ cm	↑ cm	ltr.
85060	22,5	4,5	0,8
85062	30,0	7,0	2,2



85071 1,5 ltr.



85072 3,5 ltr.

Schale „NERO“  
bowl, square  
cuenco, cuadrado  
bol creux carré



	cm	↑ cm	ltr.
85071	19,5 x 19,5	8	1,5
85072	25,0 x 25,0	11	3,5

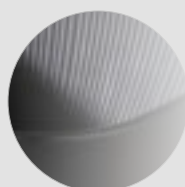
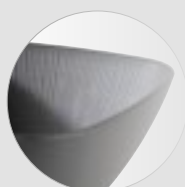

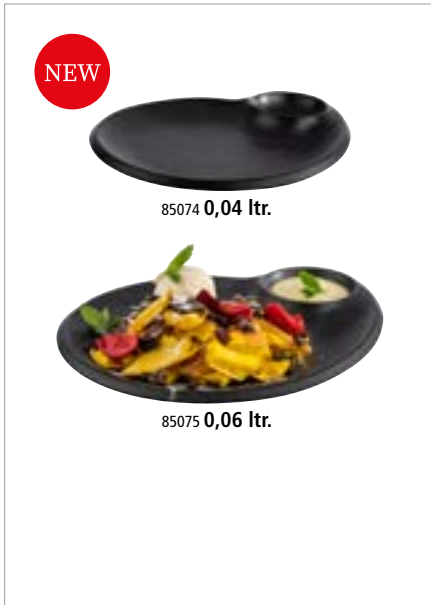

**NEW**



85074 **0,04 ltr.**



85075 **0,06 ltr.**

**Teller „NERO“**

plate  
plato  
assiette

mit integriertem Dipschälchen / Vertiefung  
with integrated dip bowl / with notch  
con cuenco para dip integrado / con ranura  
avec ramequin intégré / avec encoche



	cm	↑ cm	ltr.
85074	24 x 20	2,5	0,04
85075	30 x 25	2,5	0,06

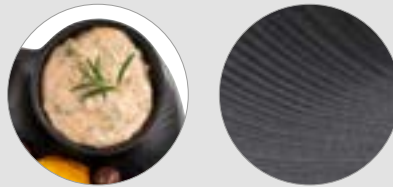

**NEW**



**Tablett „NERO“**

tray  
bandeja  
plateau

mit 2 integrierten Dipschälchen / Vertiefungen  
with 2 integrated dip bowls / with 2 notches  
con 2 cuencos para dip integrados / con 2 ranuras  
avec 2 ramequins intégrés / avec 2 encoches



	cm	↑ cm	ltr.
85097	41 x 15	2,5	2 x 0,03

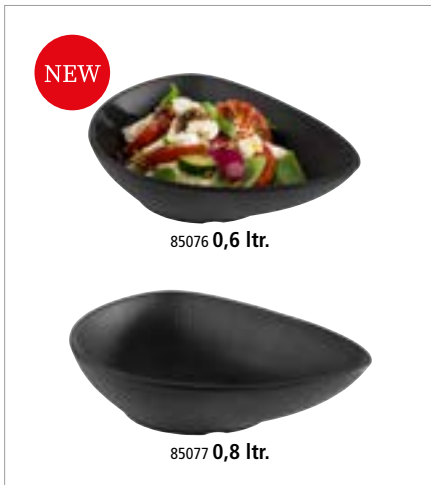

**NEW**



85076 **0,6 ltr.**



85077 **0,8 ltr.**

**Schale „NERO“**

bowl  
cuenco  
bol

	cm	↑ cm	ltr.
85076	23 x 18	5	0,6
85077	28 x 22	7	0,8

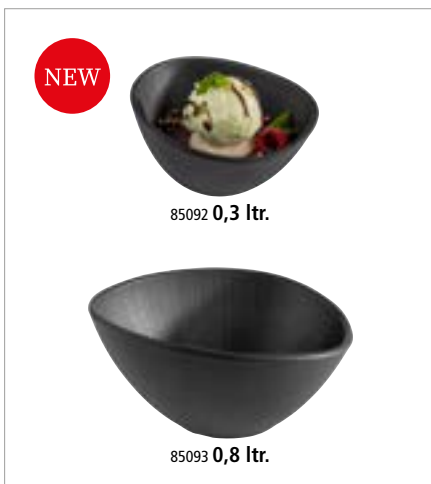
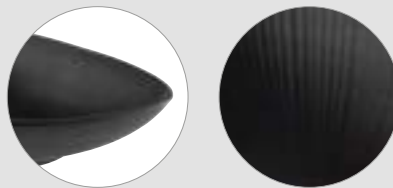

**NEW**



85092 **0,3 ltr.**



85093 **0,8 ltr.**

**Schale „NERO“**

bowl  
cuenco  
bol

	cm	↑ cm	ltr.
85092	14,5 x 12,5	8	0,3
85093	19,0 x 16,5	9	0,5

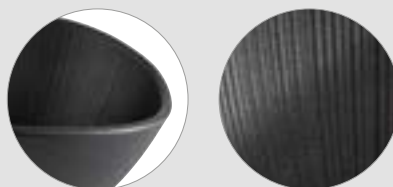



NEW

# CANCUN



NEW

**Tablett/Sushiboard „CANCUN“**  
tray/sushiboard  
bandeja para sushi  
plateau sushi



cm                      ↑ cm

85200                      23,5 x 13,5                      1,5



NEW

**Teller „CANCUN“**  
plate  
plato  
assiette



cm                      ↑ cm

85201                      28 x 13,5                      4,0



NEW

**Schale „CANCUN“**  
bowl  
cuenco  
bol



85205 **0,5 ltr.**

85207 **1,0 ltr.**

	Ø cm	↑ cm	ltr.
85205	15,0	7,0	0,5
85206	18,5	8,0	1,0
85207	20,5	6,5	1,0
85208	24,0	9,0	1,8



NEW

**Teller „CANCUN“**  
plate  
plato  
assiette



cm                      ↑ cm

85202	18,0	3,0
85203	23,0	3,5

85203



NEW

**Teller „CANCUN“**  
plate  
plato  
assiette



cm                      ↑ cm

85204	25,5	4,5
-------	------	-----



# LOOPS



## GN Tablett „LOOPS“

GN tray  
GN bandeja  
GN plateau



	cm	↑ cm	GN
85021	32,5 x 26,5	1,5	1/2

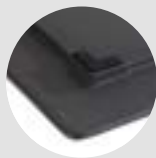

mit Antirutschfüßchen  
with non-slip feet



## Tablett/Sushiboard „LOOPS“

tray  
bandeja  
plateau



	cm	↑ cm
85025	23,5 x 13,5	1,5



85027

## Teller „LOOPS“

plate  
plato  
assiette



	Ø cm	↑ cm
85027	22	2
85028	27	2



## Teller „LOOPS“

plate  
plato  
plateau



	Ø cm	↑ cm
85024	34 x 15,5	4



## Schale „LOOPS“

bowl  
cuenco  
bol



	Ø cm	↑ cm	ltr.
85026	18	3	0,25



Schale „LOOPS“

bowl  
cuenco  
bol



	Ø cm	↑ cm	ltr.
85029	20,5	6,5	1,0
85030	31,0	8,0	2,0



Schale „LOOPS“

bowl  
cuenco  
bol



	Ø cm	↑ cm	ltr.
85036	15,0	7,0	0,5
85037	18,5	8,0	1,0
85038	24,0	9,0	1,8



Teller „LOOPS“

plate  
plato  
assiette



	cm	↑ cm
85055	28 x 13,5	4,0



Teller „LOOPS“

plate  
plato  
assiette



	Ø cm	↑ cm
85056	23	3,5



Teller „LOOPS“

plate  
plato  
assiette



	Ø cm	↑ cm
85057	25,5	4,5

# MOON



6 tlg.  
6 pcs.



85080



85081

Servierset „MOON“, 6-teilig  
serving set, 6 pcs.  
set para servir, set de 6  
set de service, set de 6

6-teiliges Set: 3 Schalen + 3 Holzlöffel (Nanmu)

6 pcs.: 3 bowls + 3 wooden spoons (Nanmu)

set de 6: 3 cuencos + 3 cucharas de madera (Nanmu)

set de 6: 3 bols + 3 cuillères en bois (Nanmu)



	Ø cm	↑ cm	ltr.	Farbe / Colour
85080	8	7,5	0,05	
85081	8	7,5	0,05	



85080



85080

84938

Tablett / tray



85081



2 tlg.  
2 pcs.



85082



85083



85084

Servierset „MOON“, 2-teilig

serving set, 2 pcs.  
set para servir, set de 2  
set de service, set de 2

2-teiliges Set: 1 Schale + 1 klappbarer Deckel

2 pcs.: 1 bowl + 1 hinged cover

set de 2: 1 cuenco + 1 tapa con bisagra

set de 2: 1 bol + 1 couvercle avec charnières



	Ø cm	↑ cm	ltr.	Farbe / Colour
85082	19	17,5	0,8	
85083	19	17,5	0,8	



85083



85082

klappbarer Deckel  
hinged cover

Präsentationsmöglichkeit  
presentation example

Klappdeckel „Moon“ mit Silikondichtung / hinged cover with silicone seal / tapa con bisagra y junta de silicona / couvercle avec charnières et joint en silicone

	Ø cm	↑ cm	fits to
85084	16	1,5	85082, 85083



85083

85082



85083



85082



85081

85080

84938  
Tablett / tray

# EMMA



85113

85116

85104

85105

85120

85101



85101 0,06 ltr



85104 0,50 ltr



85111 2,3 ltr

## Schale „EMMA“ bowl cuenco bol



MAX  
70°C



	Ø cm	↑ cm	ltr.	Farbe / Colour
85100	7,5	3,5	0,06	■
85101	7,5	3,5	0,06	■
85103	7,5	3,5	0,06	■
85104	14	6,5	0,5	■
85105	14	6,5	0,5	■
85107	14	6,5	0,5	■
85108	23	10,5	2,3	■
85109	23	10,5	2,3	■
85111	23	10,5	2,3	■

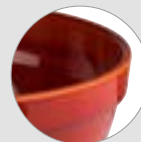
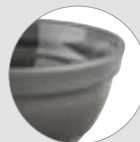
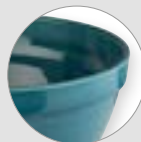





**GN Tablett „EMMA“**

GN tray  
GN bandeja  
GN plateau



	cm	↑ cm	GN	Farbe / Colour
85120	26,5 x 16,2	3	1/4	■
85121	26,5 x 16,2	3	1/4	■
85123	26,5 x 16,2	3	1/4	■
85124	32,5 x 26,5	3	1/2	■
85125	32,5 x 26,5	3	1/2	■
85127	32,5 x 26,5	3	1/2	■

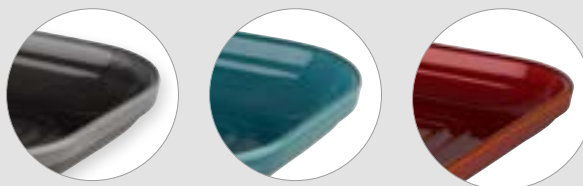

**GN Schale „EMMA“**

GN bowl  
GN cuenco  
GN bol



	cm	↑ cm	ltr.	GN	Farbe / Colour
85128	26,5 x 16,2	7,5	1,5	1/4	■
85129	26,5 x 16,2	7,5	1,5	1/4	■
85131	26,5 x 16,2	7,5	1,5	1/4	■
85132	32,5 x 26,5	7,5	3,5	1/2	■
85133	32,5 x 26,5	7,5	3,5	1/2	■
85135	32,5 x 26,5	7,5	3,5	1/2	■

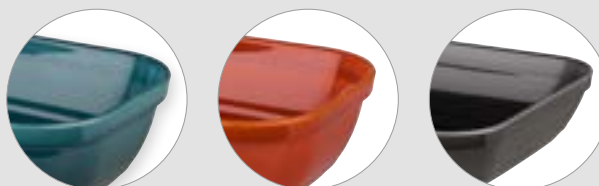

**Cooling bowl**



# APS+



**Schale, quadratisch „APS+“**  
 bowl, square  
 cuenco cuadrado  
 bol carré



	cm	↑ cm	ltr.	Farbe / Colour
15110	6,5 x 6,5	6	0,15	
15111	9,0 x 9,0	4	0,15	
15112	13,0 x 13,0	7	0,60	



**Schale, quadratisch „APS+“**  
 bowl, square  
 cuenco cuadrado  
 bol carré



	cm	↑ cm	ltr.	Farbe / Colour
15113	20,0 x 20,0	7	1,5	

	cm	↑ cm	ltr.	Farbe / Colour
15215	13,0 x 13,0	7	0,6	
15216	20,0 x 20,0	7	1,5	
15217	24,0 x 24,0	9	3,5	



**Schale, rund „APS+“**  
 bowl, round  
 cuenco, redondo  
 bol rond



	cm	↑ cm	ltr.	Farbe / Colour
15100	6,5	6	0,15	
15101	9,0	4	0,15	

	Ø cm	↑ cm	ltr.	Farbe / Colour
15200	6,5	6	0,15	
15201	9,0	4	0,15	





GN Tablett „ASIA PLUS“

GN tray  
GN bandeja  
GN plateau



	cm	↑ cm	GN	Farbe / Colour
15449	53,0 x 32,5	3	1/1	White
15450	32,5 x 26,5	3	1/2	White
15451	32,5 x 17,6	3	1/3	White
15452	26,5 x 16,2	3	1/4	White
15453	35,4 x 32,5	3	2/3	White
15454	53,0 x 16,2	3	2/4	White
15455	53,0 x 32,5	3	1/1	Red
15456	32,5 x 26,5	3	1/2	Red
15457	32,5 x 17,6	3	1/3	Red
15458	26,5 x 16,2	3	1/4	Red
15460	53,0 x 16,2	3	2/4	Red



Schale „ASIA PLUS“

bowl  
cuenco  
bol



	Ø cm	↑ cm	ltr.	Farbe / Colour
15400	7,5	3,5	0,06	White
15401	9,5	4,5	0,13	White
15402	13,0	5,5	0,35	White
15403	16,0	7,0	0,60	White
15404	20,0	8,0	1,10	White
15416	7,5	3,5	0,06	Red
15417	9,5	4,5	0,13	Red
15418	13,0	5,5	0,35	Red
15419	16,0	7,0	0,60	Red
15420	20,0	8,0	1,10	Red
15421	24,0	9,5	2,20	Red



Teller „ASIA PLUS“

plate  
plato  
assiette



	Ø cm	↑ cm	Farbe / Colour
15424	11,0	2	White
15425	16,0	2	White



Bento Box „ASIA PLUS“



	Ø cm	↑ cm	ltr.	Farbe / Colour
15461	7,5	3,0	0,04	White
15462	7,5	6,5	0,13	White
15467	7,5	3,0	0,04	Red



15473 0,05 ltr.

15474 0,16 ltr.

15485 0,05 ltr.

15486 0,16 ltr.

15475 0,10 ltr.

15477 0,15 ltr.

Bento Box „ASIA PLUS“



	cm	↑ cm	ltr.	Farbe / Colour
15473	7,5 x 7,5	3,0	0,05	
15474	7,5 x 7,5	6,5	0,16	
15485	7,5 x 7,5	3,0	0,05	
15486	7,5 x 7,5	6,5	0,16	
15475	15,5 x 7,5	3,0	0,10	
15477	15,5 x 9,5	3,0	0,15	



GN Buffetständer „ASIA PLUS“

GN buffet stand  
GN soporte para buffet  
GN présentoir buffet



Auf der kurzen und der langen Seite aufstellbar!  
Can stay on the short or long side!  
Se puede colocar por la parte corta o larga!  
Se peut installer sur le côté court ou long!

	cm	GN	Farbe / Colour
15501	53,0 x 32,5 / 53,0 x 16,2	1/1 / 2/4	
15502	32,5 x 26,5 / 26,5 x 16,2	1/2 / 1/4	
15503	32,5 x 17,5 / 35,4 x 32,5	1/3 / 2/3	
15504	53,0 x 32,5 / 53,0 x 16,2	1/1 / 2/4	
15505	32,5 x 26,5 / 26,5 x 16,2	1/2 / 1/4	
15506	32,5 x 17,5 / 35,4 x 32,5	1/3 / 2/3	

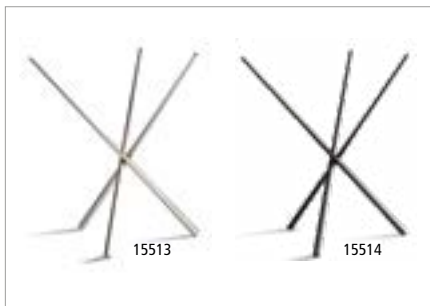

15513

15514

Buffetständer „ASIA PLUS“

buffet stand  
soporte para buffet  
présentoir buffet



	Ø cm	↑ cm	Farbe / Colour
15513	20,5 / 16,5	20	stainless steel
15514	20,5 / 16,5	20	



15320

15324

15322

Korb / Ständer „APS PLUS“

basket / riser  
cesta / soporte  
corbeille / support



	Ø cm	↑ cm	Farbe / Colour
15320	10,5 / 8	8	polished chrome
15324	10,5 / 8	8	brushed gold
15322	10,5 / 8	8	brushed copper



# BLUE OCEAN



Da geht die Sonne auf!

Maritime Aquatöne, Farbverläufe und klassisches Blau-Weiß erinnert an eine griechische Taverne in der Ägäis.

The sun is rising!

Maritime aqua tones, gradients and classic blue and white reminiscent of a Greek tavern in the Aegean Sea.

¡Está saliendo el sol!

Los tonos marinos, los degradados de color, el clásico azul y blanco recuerdan a una taberna griega en el mar Egeo.

Le soleil se lève!

Les tons maritimes, les dégradés de couleurs, le bleu et le blanc classiques, tout rappellent une taverne grecque de la mer Égée.

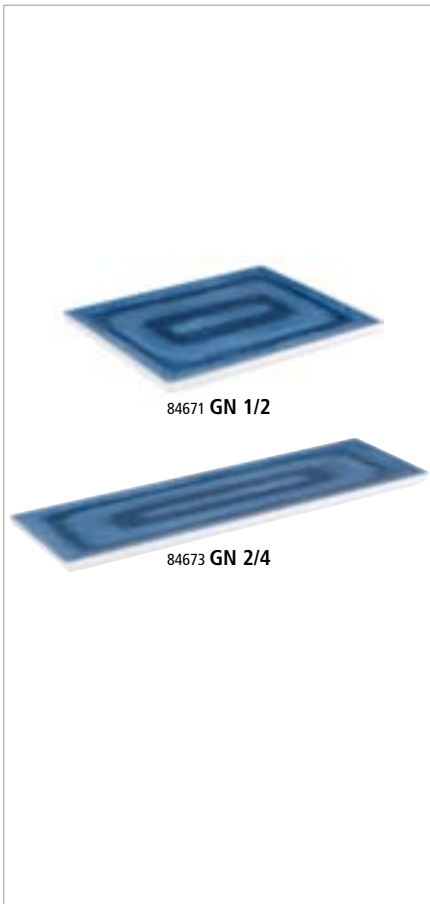

## GN Tablett „BLUE OCEAN“

GN tray  
GN bandeja  
GN plateau



	cm	↑ cm	GN
84671	32,5 x 26,5	2	1/2
84672	32,5 x 17,6	2	1/3
84673	53,0 x 16,2	2	2/4

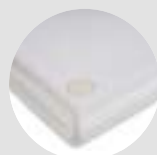

mit Antirutschfüßchen  
with non-slip feet

# BLUE OCEAN



## Tablett „BLUE OCEAN“

tray  
bandeja  
plateau



	cm	↑ cm
84676	48 x 35,5	3



## Schale „BLUE OCEAN“

bowl  
cuenco  
bol

	Ø cm	↑ cm	ltr.
84677	15	7,5	0,6
84678	30,5	9	3



## Teller „BLUE OCEAN“

plate  
plato  
assiette



	Ø cm	↑ cm
84674	21,5	2
84675	26,5	2

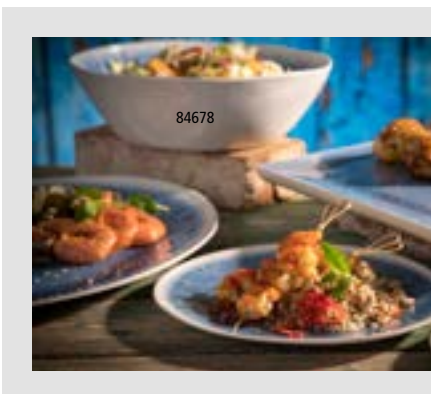



# ARABESQUE



Beim Anblick der mediterranen Melamin Serie ARABESQUE bekommt man direkt Lust auf eine Tapas-Party. Mit seinem spanischen Charme und den wundervoll ausgearbeiteten Details holen Sie sich ein Stück Spanien auf Ihr Buffet.

When looking at the Mediterranean melamine series ARABESQUE, the longing for a tapas party resurfaces. With its Spanish charm and the beautifully crafted details, you get a slice of Spain on your buffet.

Al ver la serie mediterránea de melamina ARABESQUE, se obtiene un dicho antojo por una fiesta de tapas. Con su encanto español y los detalles bellamente elaborados, obtendrá un trozo de España en su buffet.

En regardant la série de mélamine méditerranéenne ARABESQUE, vous obtenez envie de préparer une fête de tapas. Avec son charme espagnol et les détails joliment ouverts, vous aurez une tranche d'Espagne sur votre buffet.



## GN Tablett „ARABESQUE“

GN tray  
GN bandeja  
GN plateau



	cm	↑ cm	GN
84680	53,0 x 32,5	2	1/1
84681	32,5 x 26,5	2	1/2
84682	32,5 x 17,6	2	1/3
84683	53,0 x 16,2	2	2/4

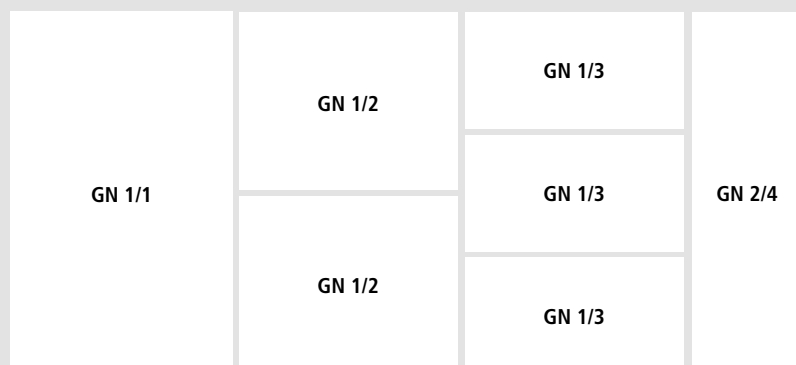

## ARABESQUE

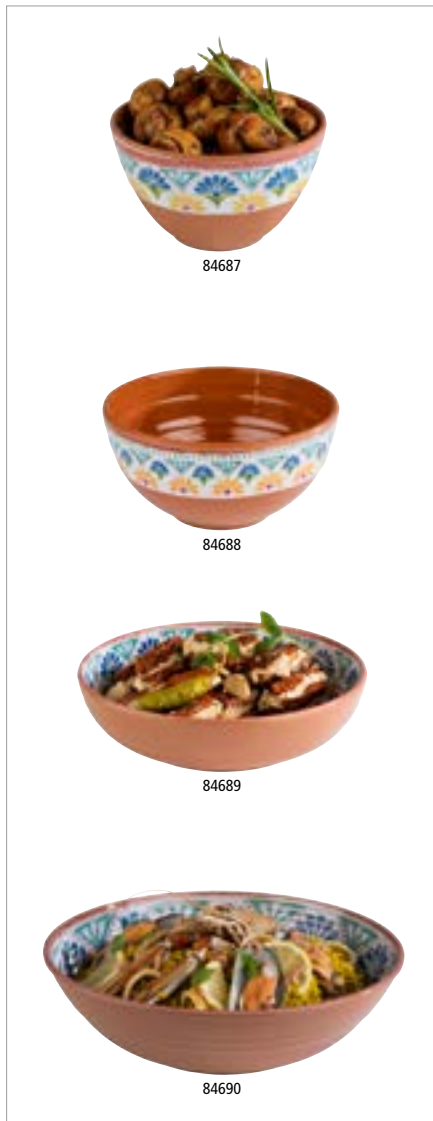

### Schale „ARABESQUE“

bowl  
cuenco  
bol



	∅ cm	↑ cm	litr.
84687	10,0	6,0	0,2
84688	15,5	8,0	0,8

	∅ cm	↑ cm	litr.
84689	20,5	5,5	1,1
84690	31,0	9,0	3,0



### Teller „ARABESQUE“

plate  
plato  
assiette



	cm	↑ cm
84686	38 x 15,5	2



### Teller „ARABESQUE“

plate  
plato  
assiette



	∅ cm	↑ cm
84684	21,5	2
84685	26,5	2

# BAMBOO



84816

## Schale „BAMBOO“

bowl  
cuenco  
bol



	cm	↑ cm	ltr.
84815	10,5 x 10,0	3,0	0,03
84816	17,5 x 15,5	5,5	0,2



## Schale „BAMBOO“

bowl  
cuenco  
bol



	Ø cm	↑ cm	ltr.
84819	30,5	8,5	2



84803

84804

84807

## Tablett „BAMBOO“

tray  
bandeja  
plateau



	cm	↑ cm
84803	10,0 x 10,0	2,0
84804	14,5 x 14,5	2,5
84805	31,0 x 10,5	2,0
84806	21,0 x 13,0	3,0
84807	24,5 x 15,5	3,0
84808	34,5 x 21,5	3,0

# STONE ART



Teller „STONE ART“  
plate  
plato  
assiette



	Ø cm	↑ cm
84510	19	2
84511	25	2
84512	30	2



Teller „STONE ART“  
plate  
plato  
assiette



	Ø cm	↑ cm	litr.
84509	15,5	2,5	0,15
84514	20,0	4,5	0,60



Teller „STONE ART“  
plate  
plato  
assiette



	Ø cm	↑ cm
84515	24,5	3,5



Teller „STONE ART“  
plate  
plato  
assiette



	cm	↑ cm
84517	33 x 32,5	3



Schale „STONE ART“

bowl  
cuenco  
bol



	Ø cm	↑ cm	ltr.
84523	8	3	0,07



Schale „STONE ART“

bowl  
cuenco  
bol



	Ø cm	↑ cm	ltr.
84524	12	6	0,3



Schale „STONE ART“

bowl  
cuenco  
bol



	Ø cm	↑ cm	ltr.
84525	15	7,5	0,6



Schale „STONE ART“

bowl  
cuenco  
bol



	cm	↑ cm	ltr.
84526	23 x 19	6,5	0,6



Schale „STONE ART“

bowl  
cuenco  
bol



	cm	↑ cm	ltr.
84528	28,5 x 21	7,5	1,2



84529

Schale „STONE ART“

bowl  
cuenco  
bol



	cm	↑ cm	ltr.
84529	19 x 19	6,0	0,5
84530	24 x 24	6,5	1,1

# STONE ART



## GN Tablett „STONE ART“

GN tray  
GN bandeja  
GN plateau



	cm	↑ cm	GN
84519	53,0 x 32,5	1,5	1/1
84520	32,5 x 26,5	1,5	1/2
84522	53,0 x 16,2	1,5	2/4
84521	32,5 x 17,6	1,5	1/3



mit Antirutschfüßchen  
with non-slip feet



## GN Abdeckhaube

GN cover  
GN cubierta  
GN cloche



passend für GN Tablett, glasklarer Kunststoff, nahezu unzerbrechlich

suitable for GN trays, clear plastic, nearly unbreakable

apto para bandejas GN, plástico transparente, muy resistente a la rotura

pour plateaux GN, plastique transparent, très résistant à la casse

	cm	↑ cm	mm	GN
11043	32,5 x 17,6	10,5	3	1/3
11044	53,0 x 16,2	10,5	3	2/4

	cm	↑ cm	mm	GN
11041	32,5 x 26,5	9,5	3	1/2
11042	53,0 x 32,5	9,5	3	1/1

# AIKO



Schalen der Serie Aiko eignen sich perfekt zum Präsentieren von leckeren Saucen, Pasten oder frischem Sushi. Aber auch kleines Fingerfood kann hübsch präsentiert und angerichtet werden.

Bowls from the Aiko series are perfect for presenting delicious sauces, pastes or fresh sushi. Also small finger food can be presented and served in a pretty way.

Los cuencos de la serie Aiko son perfectos para presentar deliciosas salsas, pastas o sushi fresco. Pero también se pueden presentar y servir de forma atractiva pequeños aperitivos.

Les bols de la série Aiko sont parfaits pour présenter de délicieuses sauces, des pâtes ou des sushis frais. Mais les petits apéritifs peuvent également être présentés et servis de manière attrayante.



## Schale „AIKO“

bowl  
cuenco  
bol

Steinoptik

appearance stoneware

su aspecto recuerda al gres

l'aspect de la mélamine rapelle le grès



	Ø cm	↑ cm	ltr.	Farbe / Colour
84329	8,0	4	0,07	■
84331	11,5	6	0,20	■



## Schale „AIKO“

bowl  
cuenco  
bol

Steinoptik

appearance stoneware

su aspecto recuerda al gres

l'aspect de la mélamine rapelle le grès



	Ø cm	↑ cm	ltr.	Farbe / Colour
84335	16,0	7	0,6	■
84337	20,5	8	1,2	■

# ELEMENT



Betonoberflächen auf dem Buffet für den Kontakt mit Lebensmitteln?  
**ELEMENT** macht es möglich.  
 Bestens geeignet im modernen und urbanen Ausstattungsumfeld.

Concrete surfaces on the buffet for food contact?  
**ELEMENT** makes it possible.  
 Ideally suited for modern and urban environments.

¿Superficies de hormigón en el buffet y tener contacto con alimentos?  
**ELEMENT** lo hace possible.  
 Ideal para ambientes modernos y urbanos.

Des surfaces en béton sur le buffet et destinées au contact alimentaire?  
**ELEMENT** le rend possible.  
 Idéal pour les environnements modernes et urbains.



## Schale „ELEMENT“

bowl  
 cuenco  
 bol



	cm	↑ cm	ltr.
84825	∅ 8,0	2,0	0,01
84826	10,5 x 10,0	3,0	0,02
84820	9,0 x 7,0	3,0	0,03
84821	10,5 x 10,5	3,0	0,04
84827	17,5 x 15,5	5,5	0,18



## Schale „ELEMENT“

bowl  
 cuenco  
 bol



	∅ cm	↑ cm	ltr.
84828	16	7	0,5
84829	28	12	3,0





82831 3,0 ltr

Schale „ELEMENT“

bowl  
cuenco  
bol



	cm	↑ cm	ltr.
84830	19 x 19	9	1,5
84831	25 x 25	12	3,8



Tablett „ELEMENT“

tray  
bandeja  
plateau



	cm	↑ cm
84824	31 x 10,5	1,5



GN Tablett „ELEMENT“

GN tray  
GN bandeja  
GN plateau



	cm	↑ cm	GN
84400	53,0 x 32,5	3,5	1/1
84401	32,5 x 26,5	3,5	1/2
84402	32,5 x 17,5	3,5	1/3
84403	26,5 x 16,2	3,5	1/4
84404	53,0 x 16,2	3,5	2/4



Schale „ELEMENT LOOK“

bowl  
cuenco  
bol



	Ø cm	↑ cm	ltr.
84835	21,5	5,5 / 9,5	0,7
84836	26,0	7,0 / 12,5	1,45
84837	30,0	8,5 / 14,5	2,3

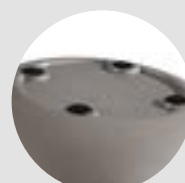
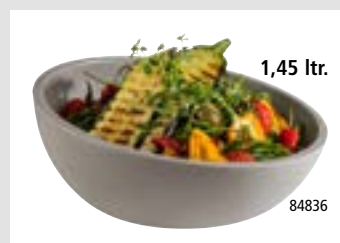

mit Antirutschfüßchen  
with non-slip feet



**GN Tablett „ELEMENT“**

GN tray  
GN bandeja  
GN plateau



	cm	↑ cm	GN	Farbe / colour
84986	56,0 x 35,5	1,5	1/1	■
84988	35,5 x 29,0	1,5	1/2	■

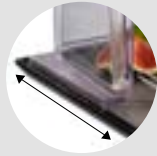

mit Antirutschrinne für Hauben  
with non-slip groove for covers

passende Hauben / suitable covers / campanas adecuadas / cloches appropriées

	cm	↑ cm	GN
11010	53,0 x 32,5	19	1/1
11027	53,0 x 32,5	9,5	1/1
11041	32,5 x 26,5	9,5	1/2
11021	33,0 x 28,0	17	1/2



**GN Tablett „BUFFET PRO“**

GN tray  
GN bandeja  
GN plateau

mit Mulde für Besteckablage  
with tray for cutlery storage  
con espacio reposa cubiertos  
avec espace repose-ustensiles



	cm	↑ cm	GN	Farbe / colour
85145	53,0 x 32,5	1,5	1/1	■
85146	32,5 x 26,5	1,5	1/2	■



mit Mulde für Vorlagegabel  
with tray for cutlery storage



Präsentationsmöglichkeit  
presentation example

# TIMBER



Tablett „TIMBER“

tray  
bandeja  
plateau



cm                      ↑ cm

84256                      70 x 26                      3



Tablett „TIMBER“

tray  
bandeja  
plateau



cm                      ↑ cm

84269                      65 x 26                      3



Tablett „TIMBER“

tray  
bandeja  
plateau



Ø cm                      ↑ cm

84266                      35                      3



Tablett „TIMBER“

tray  
bandeja  
plateau



cm                      ↑ cm

84268                      44 x 25                      1,5

# OAK



## Tablett „OAK“

tray  
bandeja  
plateau



	cm	↑ cm	Griff / handle cm
84178	40 x 20	1,5	13
84179	48 x 20	1,5	13



## Tablett „OAK“

tray  
bandeja  
plateau



	Ø cm	↑ cm	Griff / handle cm
84177	30	1,5	12



## Schale „OAK“

bowl  
cuenco  
bol



	cm	↑ cm
84434	11,5 x 7,0	2,5

# OAK LIGHT

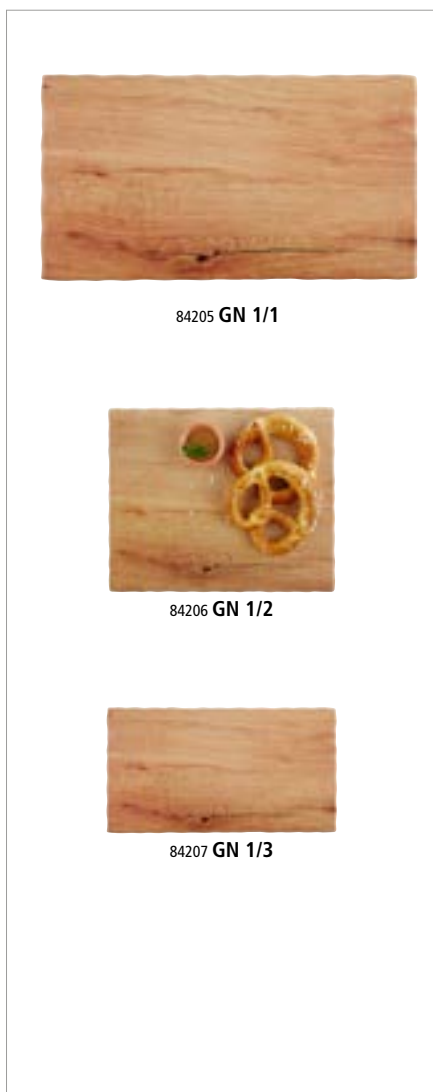

## GN Tablett „OAK LIGHT“

GN tray  
GN bandeja  
GN plateau



	cm	↑ cm	GN
84205	53,0 x 32,5	1,5	1/1
84206	32,5 x 26,5	1,5	1/2
84207	32,5 x 17,6	1,5	1/3
84208	26,5 x 16,2	1,5	1/4
84209	53,0 x 16,2	1,5	2/4



## Tablett „OAK LIGHT“

tray  
bandeja  
plateau



	cm	↑ cm
84265	65 x 26	3

# GLAMOUR



84377

84381



## Schale „GLAMOUR“

bowl  
cuenco  
bol



∅ cm      ↑ cm      ltr.

84365      8      3      0,05



## Schale „GLAMOUR“

bowl  
cuenco  
bol



∅ cm      ↑ cm      ltr.

84366      12      5      0,25



84377

84378

## Tablett „GLAMOUR“

tray  
bandeja  
plateau



cm      ↑ cm

84377      22 x 12      3,0  
84378      37 x 11      2,5



84380

84381

## Tablett „GLAMOUR“

tray  
bandeja  
plateau



cm      ↑ cm

84380      25,0 x 15,5      1,5  
84381      30,5 x 19,0      1,5



## Tablett „GLAMOUR“

tray  
bandeja  
plateau



cm      ↑ cm

84379      30 x 11      3

## CROCKER



Servier- und Buffetartikel in Tonoptik, brauner Rand. Die Oberfläche ist innen und außen fein-matt, fühlt sich an wie Ton.

Serving and buffet items, an imitation of clay, with a brown border. The surface is inside and outside fine-matt. Feels like real clay.

Artículos de servicio y buffet, imitación barro y con borde marrón. La superficie de dentro y de fuera es de deslustre fino. Parece barro natural.

Pièces de service et pour le buffet imitation argile avec bord marron. La surface est à l'intérieur et à l'extérieur bien-matte.



## Teller „CROCKER“

plate  
plato  
assiette



	cm	↑ cm	Farbe / Colour
84567	14 x 13	2,5	
84568	14 x 13	2,5	



## Teller „CROCKER“

plate  
plato  
assiette



	Ø cm	↑ cm	ltr.	Farbe / Colour
84575	20,5	3	0,50	
84576	20,5	3	0,50	

# CROCKER



## Schale „CROCKER“

bowl  
cuenco  
bol



	Ø cm	↑ cm	ltr.	Farbe / Colour
84573	16,5	4	0,50	
84574	16,5	4	0,50	



## Schale „CROCKER“

bowl  
cuenco  
bol



	Ø cm	↑ cm	ltr.	Farbe / Colour
84569	12,5	6	0,37	
84570	12,5	6	0,37	
84571	16,0	7	0,70	
84572	16,0	7	0,70	
84577	21,0	8	1,45	
84578	21,0	8	1,45	



## Blattschale „CROCKER“

leaf  
fuente en forma de hoja  
plateau feuille



	cm	↑ cm	ltr.	Farbe / Colour
84579	30,5 x 10	7,5	0,17	
84580	30,5 x 10	7,5	0,17	
84581	42 x 14	9,5	0,65	
84582	42 x 14	9,5	0,65	



# FRIDA



# FRIDA

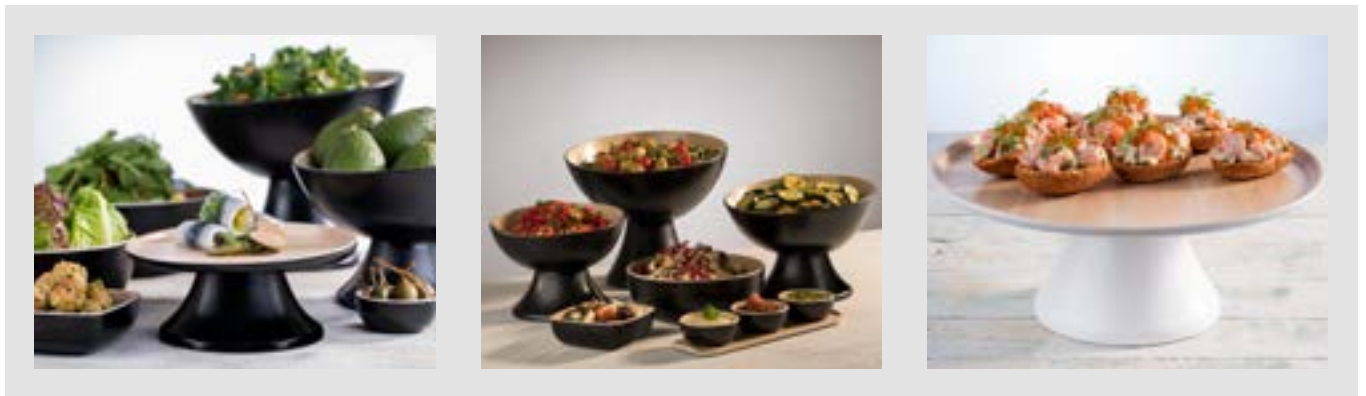



## Schale „FRIDA LOCK“

bowl  
cuenco  
bol



Schalen lassen sich durch Drehmechanismus mit dem Ständer fest verbinden

bowls can be firmly connected to the stand by a turning mechanism

los cuencos se pueden conectar firmemente al soporte mediante un mecanismo giratorio

les bols peuvent être solidement reliés au présentoir au moyen d'un mécanisme rotatif

	Ø cm	↑ cm	ltr.	Farbe / Colour
84920	21,5	7/8,5	1,0	
84921	21,5	7/8,5	1,0	
84922	25,0	8/11	1,6	
84923	25,0	8/11	1,6	
84924	28,5	10/14	2,6	
84925	28,5	10/14	2,6	

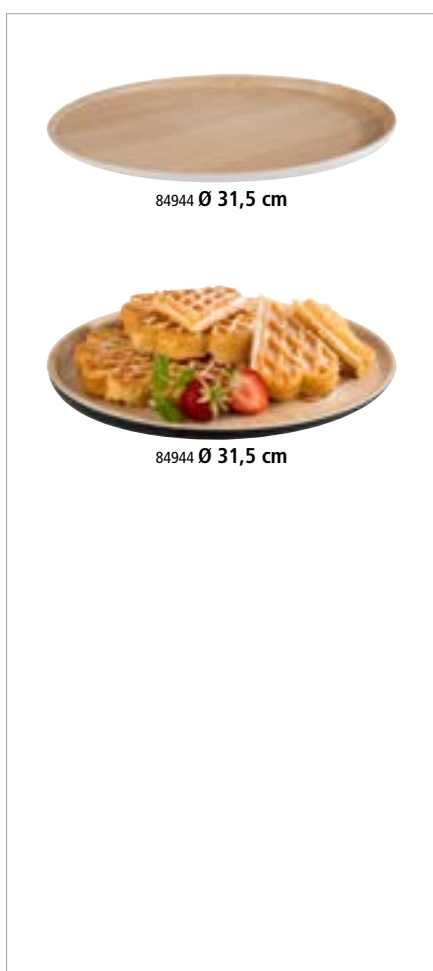

## Tablett / Platte „FRIDA LOCK“

tray  
bandeja  
plateau



Tabletts lassen sich durch Drehmechanismus mit dem Ständer fest verbinden

trays can be firmly connected to the stand by a turning mechanism

las bandejas se pueden conectar firmemente al soporte mediante un mecanismo giratorio

les plateaux peuvent être solidement reliés au présentoir au moyen d'un mécanisme rotatif

	Ø cm	↑ cm	Farbe / Colour
84943	31,5	1,5/2,5	
84944	31,5	1,5/2,5	





Ständer „FRIDA LOCK“  
stand  
soporte  
présentoir



	Ø cm	↑ cm	Farbe / Colour
84926	16,5	8	White
84927	16,5	8	Black



Ständer „FRIDA LOCK“  
stand  
soporte  
présentoir



	Ø cm	↑ cm	Farbe / Colour
84928	16,5	12	White
84929	16,5	12	Black



Haube  
cover  
campana  
cloche



	Ø cm	↑ cm	fits to
06519	21	17	84941, 84942
06520	30	22	00468, 00469, 84943, 84944
06521	36	27	84945, 84946
	Ø cm	↑ cm	fits to
06525	30	40	00468, 00469, 84943, 84944



84605 0,25 ltr.



84608 0,45 ltr.



84609 1,2 ltr.

## Schale „FRIDA“

bowl  
cuenco  
bol

	Ø cm	↑ cm	ltr.	Farbe / Colour
84605	12,5	4,5	0,25	
84606	12,5	4,5	0,25	
84607	15,0	5,5	0,44	
84608	15,0	5,5	0,44	
84609	20,0	7,5	1,20	
84610	20,0	7,5	1,20	

passende Deckel / suitable lid / tapa adecuada / couvercle approprié

	Ø cm	↑ cm	fits to
84963	13,0	2,5	84605, 84606
84964	16,0	2,5	84607, 84608



84612 2,2 ltr.



84613 3,4 ltr.

## Schale „FRIDA“

bowl  
cuenco  
bol

	Ø cm	↑ cm	ltr.	Farbe / Colour
84611	22,0	10,5	2,2	
84612	22,0	10,5	2,2	
84613	26,5	10,5	3,4	
84614	26,5	10,5	3,4	

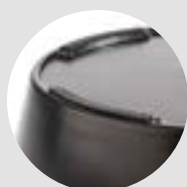
mit Antirutschfüßchen  
with non-slip feet

84930 0,1 ltr.



84933 1,8 ltr.



84934 4,7 ltr.

## Schale „FRIDA“

bowl  
cuenco  
bol

	Ø cm	↑ cm	ltr.	Farbe / Colour
84930	8,5	3,5	0,1	
84931	8,5	3,5	0,1	
84932	21,5	7,5	1,8	
84933	21,5	7,5	1,8	
84934	30,0	9,5	4,7	
84935	30,0	9,5	4,7	

passende Deckel / suitable lid / tapa adecuada / couvercle approprié

	Ø cm	↑ cm	fits to
84962	9,0	2,5	84930, 84931



Schale „FRIDA“

bowl  
cuenco  
bol



	cm	↑ cm	ltr.	Farbe / Colour
84936	12,5 x 12,5	4,5	0,37	
84937	12,5 x 12,5	4,5	0,37	
84558	16,5 x 16,5	5,5	0,85	
84559	16,5 x 16,5	5,5	0,85	
84561	25,0 x 25,0	7,5	2,65	
84562	25,0 x 25,0	7,5	2,65	

passende Deckel / suitable lid / tapa adecuada / couvercle approprié

	cm	↑ cm	fits to
84965	13,0 x 13,0	2,5	84936, 84937
84966	17,0 x 17,0	2,5	84558, 84559



GN Schale „FRIDA“

GN bowl  
GN cuenco  
GN bol



	cm	↑ cm	ltr.	GN	Farbe / Colour
84555	17,6 x 10,8	5,5	1,5	1/9	
84556	17,6 x 10,8	5,5	1,5	1/9	
84583	17,6 x 16,2	7,5	1,0	1/6	
84584	17,6 x 16,2	7,5	1,0	1/6	
84586	26,5 x 16,2	7,5	1,8	1/4	
84587	26,5 x 16,2	7,5	1,8	1/4	
84564	53 x 16,2	7,5	3,65	2/4	
84565	53 x 16,2	7,5	3,65	2/4	
84589	32,5 x 26,5	7,5	4,0	1/2	
84590	32,5 x 26,5	7,5	4,0	1/2	

passende Deckel / suitable lid / tapa adecuada / couvercle approprié

	cm	↑ cm	fits to
84968	18,0 x 11,0	2,5	84555, 84556
84967	18,0 x 16,5	2,5	84583, 84584





84592 3,5 ltr.



84593 3,5 ltr.



83601

## Schale „FRIDA“

bowl  
cuenco  
bol

	cm	↑ cm	ltr.	Farbe / Colour
84592	25 x 25	12	3,5	
84593	25 x 25	12	3,5	

## Deckel „PURE“ mit Löffelaussparung

cover with notched for spoons  
tapa con espacio para la cuchara  
couverture avec encoche pour la louche

	cm	↑ cm	fits to
83601	25 x 25	1,5	84561, 84562, 84592, 84593

mit Deckel stapelbar  
stackable with cover

84548 1,2 ltr.

## Schale „FRIDA“

bowl  
cuenco  
bol

	cm	↑ cm	ltr.	Farbe / Colour
84948	33,5 x 21	4	1,2	

als Schütte geeignet  
suitable as a chute

84987 GN 1/2

## GN Tablett „FRIDA“

GN tray  
GN bandeja  
GN plateau

	cm	↑ cm	GN	Farbe / Colour
84987	35,5 x 29,0	1,5	1/2	



84987 GN 1/2

Präsentationsmöglichkeit  
presentation example

passende Hauben / suitable covers / campanas adecuadas / cloches appropriées

	cm	↑ cm	GN
11021	33,0 x 28,0	17,0	1/2

mit Antirutschrinne für Hauben  
with non-slip groove for covers

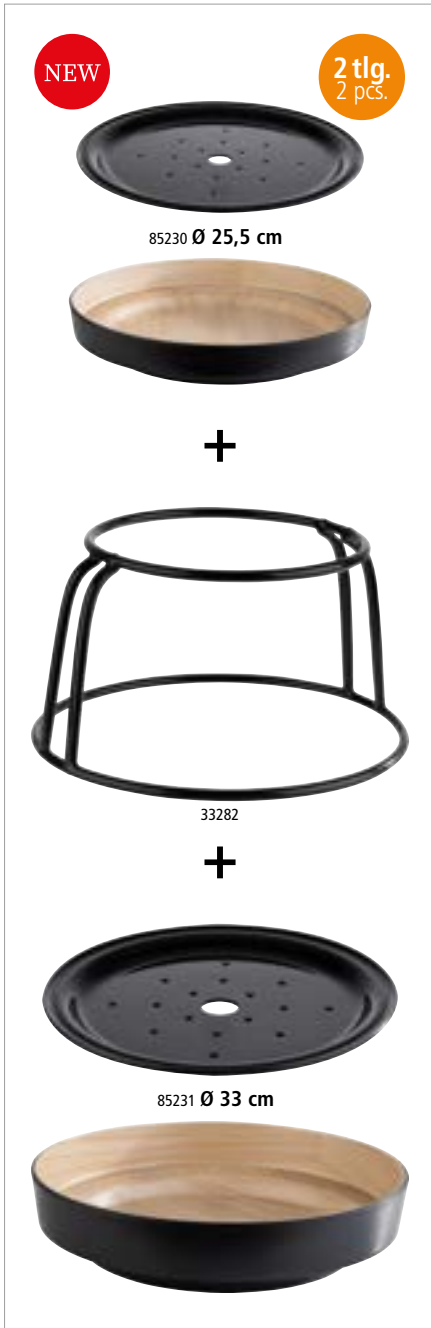

**Schale, 2-teilig „FRIDA“**

bowl, 2 pcs.  
cuenco, set de 2  
bol, set de 2



inklusive Abtropfeinsatz  
including drip tray  
con escurridor  
avec égouttoir

	Ø cm	↑ cm	Farbe / Colour
85230	25,5	6	■ ■
85231	33,0	6	■ ■

**Buffetständer**

buffet stand  
soporte para buffet  
présentoir buffet



Metall, mit schwarzer Antirutschbeschichtung, für Schalen Nr. 85230, 85231  
metal, with black anti-slide coating, for bowls no. 85230, 85231  
metal, con revestimiento antideslizante negro, para cuencos 85230, 85231  
métal, avec revêtement antidérapant noir, pour bols 85230, 85231

	Ø cm	↑ cm	Farbe / Colour
33282	23 / 30,5	17	■



Präsentationsmöglichkeit  
presentation example



inklusive Abtropfeinsatz  
including drip tray

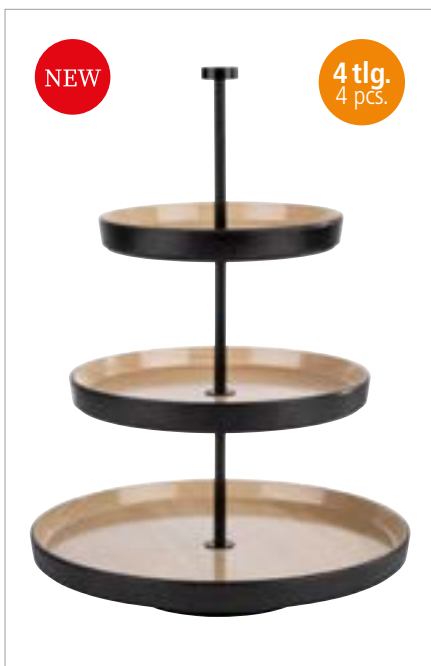

**3-stufige Etagère „FRIDA“**

3-tier tray  
bandeja con 3 alturas  
étagère carré 3 hauteurs



1 Gestell aus Edelstahl, schwarz, 3 Schalen aus Melamin: Ø 20 / 25 / 32 cm  
1 stainless steel frame, black, 3 melamine bowls: Ø 20 / 25 / 32 cm  
1 soporte de acero inoxidable, negro, 3 cuencos de melamina: Ø 20 / 25 / 32 cm  
1 support en acier inox, noir, 3 bols en mélamine: Ø 20 / 25 / 32 cm

	Ø cm	↑ cm	Farbe / Colour
85211	20 / 25 / 32	43	■ ■ ■

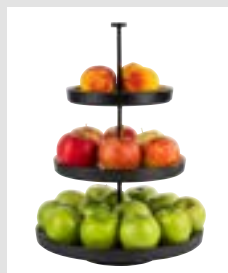



# SLATE



Die schwarzen Melaminplatten überzeugen mit ihrem edlen und schlichten Schieferlook und einer rauhen Oberfläche.

The black melamine trays convince with their noble and simple slate look and a rough surface.

Las bandejas de melamina negras convencer por su aspecto de pizarra elegante y discreto y una superficie áspera.

Les plateaux en mélamine noirs convainquent grâce au aspect de l'ardoise élégant et discret et une surface rugueuse.



## GN Tablett „SLATE“

GN tray  
GN bandeja  
GN plateau



	cm	↑ cm	GN
83955	53,0 x 32,5	1	1/1
83956	32,5 x 26,5	1	1/2
83957	32,5 x 17,6	1	1/3
83958	26,5 x 16,2	1	1/4
83971	53,0 x 16,2	1	2/4



## GN Tablett „SLATE“

GN tray  
GN bandeja  
GN plateau

massive Metallgriffe verchromt inkl. fest verschraubten 4 cm Distanzstücken  
chrome plated handles, incl. mounted 4 cm distance pillars  
asas cromadas, incluye distanciadores de 4 cm firmemente montados  
poignées chromées, y compris piliers de distance montées de 4 cm

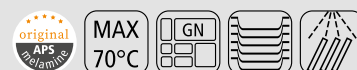

	cm	↑ cm	GN
83980	53 x 32,5	6	1/1

## SLATE



### GN Tablett „SLATE“

GN tray  
GN bandeja  
GN plateau



	cm	↑ cm	GN
83981	53 x 32,5	1,5	1/1



Schieferoptik  
slate look



83994

### Tablett „SLATE“

tray  
bandeja  
plateau



	Ø cm	↑ cm
83992	30	1
83994	40	1



NEW

11056

85099

30336

### Tablett „SLATE“

tray  
bandeja  
plateau

passend zu Etagère 30336

suitable for 2-tier tray 30336

adecuado para soporte 2 alturas 30336

adapté à étagère 2 niveaux



	cm	↑ cm
85099	28,0 x 15,5	1,0



Haube / cover / campana / cloche

	cm	↑ cm
11056	26,0 x 12,0	10,0



84245

83600

83601

### Schale „SLATE“

bowl  
cuenco  
bol



	cm	↑ cm	ltr.
84244	19 x 19	9	1,5
84245	25 x 25	12	3,8

Deckel „PURE“ mit Löffelaussparung

cover with notched for spoons

tapa con espacio para la cuchara

couvercle avec encoche pour la louche

	cm	↑ cm	fits to
83600	19 x 19	1,5	84244
83601	25 x 25	1,5	84245



# SLATE ROCK

84258

84259

84257



84258

84259

84257

## Tablett „SLATE-ROCK“

tray  
bandeja  
plateau



Die schwarzen Melaminplatten überzeugen mit ihrem Schieferlook

The black melamine trays convince with their slate look

Las bandejas de melamina negras convencen por su aspecto de pizarra

Les plateaux en mélamine noirs convainquent grâce au aspect de l'ardoise

	cm	↑ cm	Griff / handle cm
84258	40 x 20	1,5	13
84259	48 x 20	1,5	13
	Ø cm	↑ cm	Griff / handle cm
84257	30	1,5	12



7 tlg.  
7 pcs.

## Serving-Box

serving box  
caja comida  
boîte-repas



7 teiliges Set:

- 1 Box + 1 Deckel
- 1 Schale groß (23 x 14 x 6 cm, 1,4 ltr.)
- 1 Schale mittel (14 x 11,5 x 6 cm, 0,6 ltr.)
- 2 Schalen klein (11,5 x 7 x 6 cm, 0,25 ltr.)
- 1 Antirutsch-Matte (26 x 21 cm)

7 pcs.:

- 1 box + 1 cover
- 1 bowl large (23 x 14 x 6 cm, 1,4 ltr.)
- 1 bowl medium (14 x 11,5 x 6 cm, 0,6 ltr.)
- 2 bowls small (11,5 x 7 x 6 cm, 0,25 ltr.)
- 1 non-slip mat (26 x 21 cm)

set de 7:

- 1 caja + 1 tapa
- 1 cuenco, grande (23 x 14 x 6 cm, 1,4 ltr.)
- 1 cuenco mediano (14 x 11,5 x 6 cm, 0,6 ltr.)
- 2 cuencos pequeños (11,5 x 7 x 6 cm, 0,25 ltr.)
- 1 esterilla antideslizante (26 x 21 cm)

set de 7:

- 1 boîte + 1 couvercle
- 1 bol, grand (23 x 14 x 6 cm, 1,4 ltr.)
- 1 bol moyen (14 x 11,5 x 6 cm, 0,6 ltr.)
- 2 bols petits (11,5 x 7 x 6 cm, 0,25 ltr.)
- 1 tapis antidérapant (26 x 21 cm)

	Ø cm	↑ cm	Farbe / colour
85088	30 x 25	8	■



stapelbar  
stackable

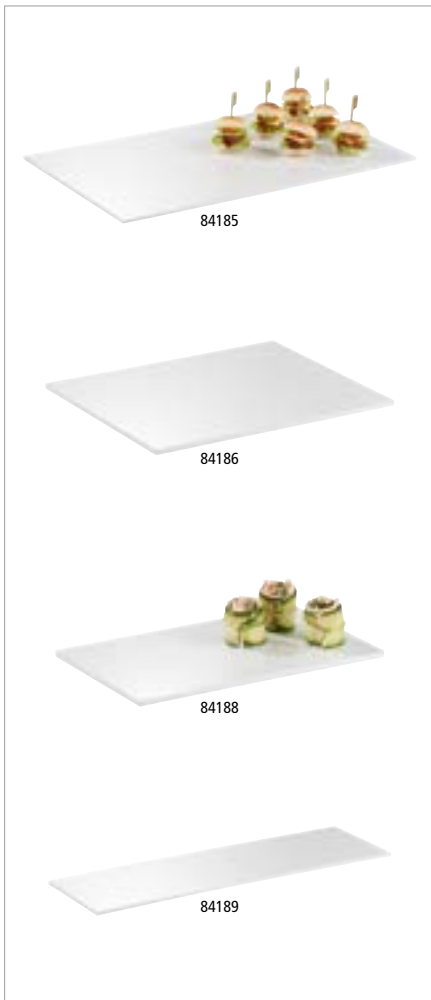

**GN Tablett „ZERO“**

GN tray  
GN bandeja  
GN plateau

glatte, hochglänzende Oberfläche  
smooth and shiny surface  
superficie lisa con acabado brillante  
surface lisse et finition brillante



	cm	↑ cm	GN	Farbe / Colour
84185	53,0 x 32,5	1,5	1/1	
84186	32,5 x 26,5	1,5	1/2	
84187	32,5 x 17,6	1,5	1/3	
84188	26,5 x 16,2	1,5	1/4	
84189	53,0 x 16,2	1,5	2/4	

passende Hauben / suitable covers / campanas adecuadas / cloches appropriées

	cm	↑ cm	* mm	GN
11042	53,0 x 32,5	9,5	3	1/1
11041	32,5 x 26,5	9,5	3	1/2
11043	32,5 x 17,6	10,5	3	1/3
11044	53,0 x 16,2	10,5	3	2/4



mit Antirutschfüßchen  
with non-slip feet



**GN Tablett „DRIFTWOOD“**

GN tray  
GN bandeja  
GN plateau

die Melaminplatten (Holzoptik) haben eine leicht wellige Oberfläche und wirken optisch wie aus Holz gefertigt

the melamine trays (wood look) have a slightly wavy surface and look visually as made of natural wood

las bandejas de melamina (imitación madera) tienen una superficie ligeramente ondulada y parecen estar hechas de madera natural

les plateaux de mélamine (imitation bois) ont une surface légèrement ondulée et donnent une impression visuelle de bois naturelle



	cm	↑ cm	GN
84180	53,0 x 32,5	1,5	1/1
84181	32,5 x 26,5	1,5	1/2
84182	32,5 x 17,6	1,5	1/3



Oberflächenansicht  
surface view



# CIRCLE



## Tablett „CIRCLE“

plate / tray  
plato / bandeja  
assiette / plateau



	Ø cm	↑ cm	Farbe / Colour
84875	32,0	3,5	

# LA VIDA



## Tablett „LA VIDA“

plate / tray  
plato / bandeja  
assiette / plateau



	Ø cm	↑ cm	Farbe / Colour
84161	32,0	3,5	
84170	40,5	5,5	
84171	32,0	3,5	
84172	40,5	5,5	



# MARONE

Eine derbe Oberflächenstruktur schafft ein natürliches Erscheinungsbild.

Die schwarzen Schalenvarianten mit braunem Rand inszenieren Ihr Gericht sehr stilvoll.

A rough surface structure creates a natural appearance.

The black bowls and trays with brown border stage your dishes in a very stylish way.

La estructura rugosa de la superficie crea una apariencia natural.

Los diferentes cuencos negros con borde marrón ponen con mucho estilo en escena sus platos.

La structure de surface rugueuse crée une apparence naturelle.

Les différents bols noirs avec rebord marron mettent élégamment en scène vos plats.

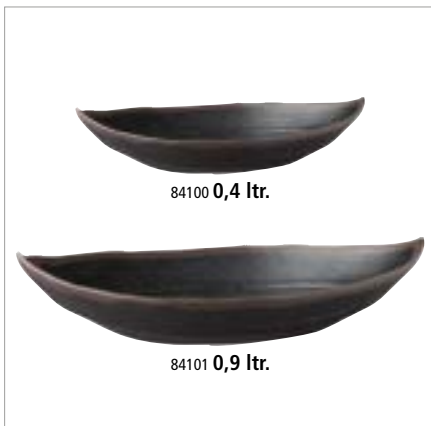

## Blattschale „MARONE“ leaf fuente en forma de hoja plateau feuille



	cm	↑ cm	ltr.
84100	25,5 x 14	5,5	0,4
84101	36,0 x 19	8,0	0,9



## Schale „MARONE“ bowl cuenco bol



	cm	↑ cm	ltr.
84731	16,5 x 10	5,5	0,25
84732	22,0 x 13	7,5	0,6
84733	27,5 x 19	9,0	1,4



Oberflächenansicht  
surface view



84107 0,05 ltr.



84108 0,04 ltr.

Schale „MARONE“

bowl  
cuenco  
bol



	Ø cm	↑ cm	ltr.
84107	8,5	2,5	0,05
84108	11,5	3,0	0,04



84115 0,2 ltr.



84116 0,2 ltr.

Schale „MARONE“

bowl  
cuenco  
bol



	Ø cm	↑ cm	ltr.
84115	11	3,5	0,13
84116	14	4,0	0,20



84109 0,2 ltr.

Schale „MARONE“

bowl  
cuenco  
bol



	Ø cm	↑ cm	ltr.
84109	11	5,5	0,2



84111 0,8 ltr.

Schale „MARONE“

bowl  
cuenco  
bol



	Ø cm	↑ cm	ltr.
84110	14	6,0	0,30
84111	19	8,0	0,80
84112	21	8,5	1,00
84113	24	9,5	1,40



84174 2,0 ltr.

Schale „MARONE“

bowl  
cuenco  
bol



	Ø cm	↑ cm	ltr.
84174	30,5	8,5	2

## MARONE



### Tablett „MARONE“

tray  
bandeja  
plateau



MAX  
70°C



	cm	↑ cm
84117	19,5 x 9,5	2
84118	39,0 x 16,0	3



### Tablett „MARONE“

tray  
bandeja  
plateau



MAX  
70°C



	cm	↑ cm
84119	32,5 x 23,5	4,5



### Tablett „MARONE“

tray  
bandeja  
plateau



MAX  
70°C



	cm	↑ cm
84104	22,5 x 15	3
84105	27,5 x 11	2



### Tablett „MARONE“

tray  
bandeja  
plateau



MAX  
70°C



	cm	↑ cm
84103	14,5 x 14,5	2



### Tablett „MARONE“

tray  
bandeja  
plateau



MAX  
70°C



	cm	↑ cm
84106	26,5 x 16,5	4



### Teller „MARONE“

plate  
plato  
assiette



MAX  
70°C



	Ø cm	↑ cm
84728	16,0	2,5
84729	20,5	2,5
84730	28,0	3,5





# DARK WAVE



## GN Tablett „DARK WAVE“

GN tray  
GN bandeja  
GN plateau



	cm	↑ cm	GN
84900	53,0 x 32,5	2	1/1
84901	32,5 x 26,5	2	1/2
84902	32,5 x 17,6	2	1/3
84903	53,0 x 16,2	2	2/4



mit Antirutschfüßchen  
with non-slip feet

## DARK WAVE



### Tablett „DARK WAVE“

tray  
bandeja  
plateau



MAX  
70°C



	cm	↑ cm
84904	14 x 14	2



### Tablett „DARK WAVE“

tray  
bandeja  
plateau



MAX  
70°C



	cm	↑ cm
84905	23 x 10,5	1,5
84906	29 x 12,0	1,5



### Teller „DARK WAVE“

plate  
plato  
assiette



MAX  
70°C



	Ø cm	↑ cm
84907	14,5	1,5
84908	22,0	2,0
84909	27,0	2,5



### Schale „DARK WAVE“

bowl  
cuenco  
bol



MAX  
70°C



	Ø cm	↑ cm	litr.
84910	17,5	5,0	0,50
84911	22,5	5,0	0,75
84912	32,0	3,5	–

## ZEN



Fernöstliche Tisch- und Buffetartikel präsentiert die Serie ZEN. Die Optik entspricht dem japanischen Steingut.

The ZEN series presents Far Eastern table and buffet articles. The appearance is that of Japanese stoneware.

La colección ZEN presenta artículos de buffet y mesa para la cocina oriental. Su aspecto recuerda al gres japonés.

La collection ZEN présente des articles de buffet et de table pour la cuisine orientale. L'aspect de la mélamine rappelle le grès japonais.



## Schale „ZEN“

bowl  
cuenco  
bol



	Ø cm	↑ cm	ltr	Farbe / Colour
83929	31	8,5	2,5	■



## Schale „ZEN“

bowl  
cuenco  
bol



	Ø cm	↑ cm	ltr	Farbe / Colour
84355	22,5	12,5	0,80	■



## Schale „ZEN“

bowl  
cuenco  
bol



	cm	↑ cm	ltr	Farbe / Colour
83712	21 x 21	11	1,40	■



## Schale „ZEN“

bowl  
cuenco  
bolMAX  
70°C

	Ø cm	↑ cm	ltr.	Farbe / Colour
84348	10,0	7,0	0,08	■
84349	10,0	7,0	0,08	■
84351	12,5	8,5	0,15	■
84353	16,0	10,0	0,30	■

stapelbar  
stackable

## Schale „ZEN“

bowl  
cuenco  
bolMAX  
70°C

	cm	↑ cm	ltr.	Farbe / Colour
83735	25,0 x 13,5	4	0,25	■
83739	30,5 x 17,5	5	0,60	■



## Schale „ZEN“

bowl  
cuenco  
bolMAX  
70°C

	cm	↑ cm	ltr.	Farbe / Colour
83716	17,5 x 17,5	7	0,5	■



## Schale „ZEN“

bowl  
cuenco  
bolMAX  
70°C

	cm	↑ cm	ltr.	Farbe / Colour
83725	10,5 x 10,5	3	0,06	■
83727	10,5 x 10,5	3	0,06	■



## Dipschälchen „ZEN“

dip bowl  
cuenco para dip  
bol para dipMAX  
70°C

	Ø cm	↑ cm	ltr.	Farbe / Colour
83721	8	1,5	0,03	■
83723	8	1,5	0,03	■



## Schale „ZEN“

bowl  
cuenco  
bol

	cm	↑ cm	ltr.	Farbe / Colour
83718	12 x 12	4	0,2	
83720	12 x 12	4	0,2	



## Schale „ZEN“

bowl  
cuenco  
bol

	cm	↑ cm	ltr.	Farbe / Colour
83726	13 x 11	3,5	0,1	
83728	13 x 11	3,5	0,1	



## Schale „ZEN“

bowl  
cuenco  
bol

	cm	↑ cm	ltr.	Farbe / Colour
83730	11 x 10	3	0,04	
83732	11 x 10	3	0,04	



## Schale „ZEN“

bowl  
cuenco  
bol

	cm	↑ cm	ltr.	Farbe / Colour
83722	17,5 x 15,5	5,5	0,2	
83724	17,5 x 15,5	5,5	0,2	



## Schale „ZEN“

bowl  
cuenco  
bol

	cm	↑ cm	ltr.	Farbe / Colour
83935	14,5 x 12,5	5	0,2	



## Schale „ZEN“

bowl  
cuenco  
bol

	Ø cm	↑ cm	ltr.	Farbe / Colour
83932	11,5	4	0,15	
83933	11,5	4	0,15	



## Schale „ZEN“

bowl  
cuenco  
bol

	cm	↑ cm	ltr.	Farbe / Colour
83946	9 x 7	2,5	0,05	White
83947	9 x 7	2,5	0,05	Black



## Schale „ZEN“

bowl  
cuenco  
bol

	cm	↑ cm	Farbe / Colour
83949	14 x 9	2,5	Black



## Tablett / Teller „ZEN“

tray / plate  
bandeja / plato  
plateau / assiette

	Ø cm	↑ cm	Farbe / Colour
83941	28	3	Black



## Tablett / Sushiboard „ZEN“

tray / sushiboard  
bandeja para sushi  
plateau sushi

	cm	↑ cm	Farbe / Colour
83742	22,5 x 9,5	3	White
83744	22,5 x 9,5	3	Black



## Tablett / Sushiboard „ZEN“

tray / sushiboard  
bandeja para sushi  
plateau sushi

	cm	↑ cm	Farbe / Colour
83740	22 x 12	3	Black



# SINUS

84231

Charakterstark und mit dem Anspruch an Funktionalität und Design präsentiert sich die Buffetserie SINUS. Die großzügigen Flächen für die Speisenpräsentation sind ausdrucksstark eingefasst und gewährleisten ein optimales Handling.

The SINUS buffet series is characterful and with a high standard of functionality and design. The spacious areas for the food presentation are expressively enclosed and ensure optimal handling in everyday dining.

La serie de buffet SINUS demuestra un caracter fuerte y tiene un alto nivel de funcionalidad y diseño. Las áreas espaciaosas para la presentación de la comida son expresivamente enmarcadas y aseguran un manejo óptimo en la gastronomía.

La série de buffet SINUS est pleine de caractère et avec un haut niveau de fonctionnalité et de design. Les zones spacieuses pour la présentation de la nourriture sont expressivement encadré et assurent une maniabilité optimale dans la restauration.



**GN Tablett „SINUS“**  
 GN tray  
 GN bandeja  
 GN plateau

original APS melamine MAX 70°C

	cm	↑ cm	GN	Farbe / Colour
84230	53 x 32,5	2	1/1	White
84231	53 x 16,2	2	2/4	White



**Schale „SINUS“**  
 bowl  
 cuenco  
 bol

original APS melamine MAX 70°C

	cm	↑ cm	ltr.
84232	21,0 x 21,0	9,0	1,5
84233	25,0 x 25,0	11,0	2,4

# HALFTONE



## Fingerfoodlöffel „HALFTONE“

party spoon  
cuchara party  
cuillère party



	∅ cm	↑ cm	Farbe / Colour	VE / unit
84158	5,5	7		24



## Fingerfoodlöffel „HALFTONE“

party spoon  
cuchara party  
cuillère party



	cm	↑ cm	Farbe / Colour	VE / unit
84128	14,5 x 4,5	4,5		12



## Tablett „HALFTONE“

tray  
bandeja  
plateau



	cm	↑ cm
84125	24,5 x 15,0	3



## Tablett „HALFTONE“

tray  
bandeja  
plateau



	cm	↑ cm
84126	29 x 18	4



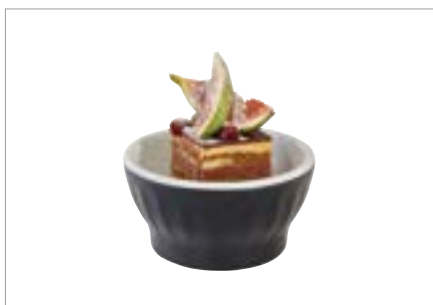

Schale „HALFTONE“

bowl  
cuenco  
bol



	Ø cm	↑ cm	ltr.	VE / unit
84217	8	4	0,1	12



84130

84134

Schale „HALFTONE“

bowl  
cuenco  
bol



	cm	↑ cm	ltr.
84130	11,5 x 7,0	4,0	0,05
84131	14,0 x 8,0	4,5	0,10
84132	15,0 x 9,5	5,0	0,15
84133	17,5 x 13,5	6,5	0,35
84134	24,0 x 17,5	7,5	0,8



Schale „HALFTONE“

bowl  
cuenco  
bol



	Ø cm	↑ cm	ltr.
84135	16,5	7,5	0,65

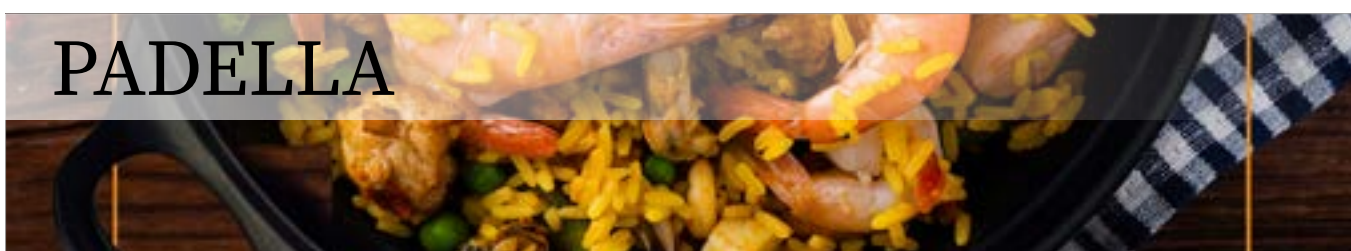

PADELLA



85150 1,5 ltr.

85151 3,0 ltr.

Schale „PADELLA“

bowl  
cazuelita  
plat 2 anses „cocotte“



	Ø cm	↑ cm	ltr.	Griff / handle cm
85150	21	9	1,5	5 x 3,5
85151	28	9	3,0	5 x 3,5



stapelbar und rutschfest  
stackable and nonslip

# APART



### GN Tablett „APART“

GN tray  
GN bandeja  
GN plateau



	cm	↑ cm	GN
83828	53,0 x 32,5	2,5	1/1
83830	32,5 x 26,5	2,5	1/2



### Dipschälchen „APART“

dip bowl  
cuenco para dip  
ramequin



	Ø cm	↑ cm	litr.
83800	6,5	3,0	0,045



### Dipschälchen „APART“

dip bowl  
cuenco para dip  
ramequin



	cm	↑ cm	litr.
83808	6,5 x 6,5	3,0	0,05

# CASCADE



### Schale „CASCADE“

bowl  
cuenco  
bol



	cm	↑ cm	GN	litr.
83960	32,5 x 26,5	7,5	1/2	3,65
83962	26,5 x 16,2	7,5	1/4	1,50
83961	53 x 16,2	7,5	2/4	3,65



Außenmaße Gastronorm  
size Gastronorm

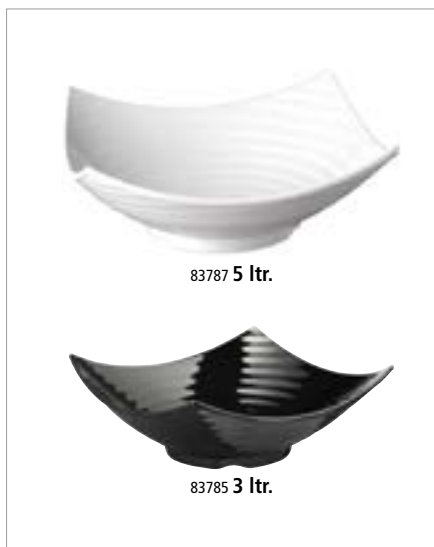

Schale „GLOBAL BUFFET“

bowl  
cuenco  
bol



	cm	↑ cm	ltr.	Farbe / Colour
83785	32,5 x 32,5	12,0	3,0	White
83787	40,0 x 40,0	13,5	5,0	White
84785	32,5 x 32,5	12,0	3,0	Black



Schale „GLOBAL BUFFET“

bowl  
cuenco  
bol



	cm	↑ cm	ltr.	Farbe / Colour
84464	35,5 x 31,5	14,0	2,5	White
84466	46,0 x 40,0	18,5	5,5	White



Schale „GLOBAL BUFFET“

bowl  
cuenco  
bol



	cm	↑ cm	ltr.	Farbe / Colour
83799	25,5 x 25,5	13,0	3,0	White
83788	32,0 x 32,0	16,5	4,5	White
83789	35,0 x 35,0	17,0	6,0	White
83790	40,0 x 40,0	17,5	8,0	White



Schale „GLOBAL BUFFET“

bowl  
cuenco  
bol



	cm	↑ cm	ltr.	Farbe / Colour
84462	44 x 25	20	3,3	White



Schale „LEAF“

bowl  
cuenco  
bol



	cm	↑ cm	ltr.	Farbe / Colour
84200	42 x 19,5	6,5	1,0	White
84202	50 x 23,0	7,5	1,5	White

# FLYING BUFFET



## Fingerfood-Teller „FLYING BUFFET“

fingerfood plate  
plato para el aperitivo  
assiette pour apéritif



	cm	↑ cm	Farbe / Colour
83878	9,5 x 9,5	1,5 / 3,5	White
83879	9,5 x 9,5	1,5 / 3,5	Black



## Schale „FLOAT“

bowl  
cuenco  
bol



	cm	↑ cm	Farbe / Colour
83912	9 x 9	4,5	White
83913	9 x 9	4,5	Black



## GN Tablett „APART“

GN tray  
GN bandeja  
GN plateau



	cm	↑ cm	GN
83828	53 x 32,5	2,5	1/1
83830	32,5 x 26,5	2,5	1/2



## GN Edelstahl Tablett

GN stainless steel platter  
GN bandeja de acero inoxidable  
GN plateau en acier inox



	cm	GN
11119	53 x 32,5	1/1



# FLOAT



- Ideal für den Thekenbereich
- stapelbar mit Löffel und Deckel
- Schalenboden fixiert sich auf dem Deckel
- rutschfest (Antirutschfüßchen)

- ideal for the counter area
- stackable with spoon and lid
- the bottom of the bowl is fixed on the lid
- non-slip (with non-slip feet)

- ideal para la zona del mostrador
- apilable con cuchara y tapa
- el fondo del cuenco se fija en la tapa
- antideslizante (con pies antideslizantes)

- idéal pour l'aire de comptoir
- empilable avec cuillère et couvercle
- le fond du bol se fixe sur le couvercle
- antidérapant (avec pieds antidérapants)



## Schale „FLOAT“ bowl cuenco bol



	Ø cm	↑ cm	ltr.	Farbe / Colour
83900	5,5	3,0	0,03	White
83902	9,0	4,5	0,15	White
83904	13,0	6,5	0,45	White
83906	15,0	7,5	0,70	White
83908	20,5	10,0	1,90	White
83901	5,5	3,0	0,03	Black
83903	9,0	4,5	0,15	Black
83905	13,0	6,5	0,45	Black
83907	15,0	7,5	0,70	Black
83909	20,5	10,0	1,90	Black

# FLOAT



## Schale „FLOAT“

bowl  
cuenco  
bol



	cm	↑ cm	ltr.	Farbe / Colour
83910	5,5 x 5,5	3,0	0,03	White
83912	9,0 x 9,0	4,5	0,16	White
83914	12,5 x 12,5	6,0	0,50	White
83916	19,0 x 19,0	9,5	1,90	White
83918	25,0 x 25,0	12,0	4,70	White
83911	5,5 x 5,5	3,0	0,03	Black
83913	9,0 x 9,0	4,5	0,16	Black
83915	12,5 x 12,5	6,0	0,50	Black
83917	19,0 x 19,0	9,5	1,90	Black
83919	25,0 x 25,0	12,0	4,70	Black



stapelbar  
stackable



## GN Tablett „FLOAT“

GN tray  
GN bandeja  
GN plateau



	cm	↑ cm	GN	Farbe / Colour
83923	53,0 x 32,5	3	1/1	White
83925	32,5 x 26,5	3	1/2	White
83924	53,0 x 32,5	3	1/1	Black
83926	32,5 x 26,5	3	1/2	Black



## Deckel „FLOAT“ mit Löffelaussparung

cover with notched for spoons  
tapa con espacio para la cuchara  
couverture avec encoche pour la louche



	cm	↑ cm	fits to
83920	Ø 20,5	1,3	83908, 83909
83921	19 x 19	1,3	83916, 83917
83922	25 x 25	1,3	83918, 83919

# PURE



83401

83479

## Tablett „PURE“

tray  
bandeja  
plateau



	cm	↑ cm	GN	Farbe / Colour
83401	53,0 x 32,5	3	1/1	
83433	53,0 x 16,2	3	2/4	
83480	32,5 x 26,5	3	1/2	
83481	32,5 x 17,6	3	1/3	
83482	26,5 x 16,2	3	1/4	
83597	40,0 x 30,0	3	Bäcker-Maß	

	cm	↑ cm	GN	Farbe / Colour
83479	53,0 x 32,5	3	1/1	
83434	53,0 x 16,2	3	2/4	
83490	32,5 x 26,5	3	1/2	
83491	32,5 x 17,6	3	1/3	
83492	26,5 x 16,2	3	1/4	
83592	40,0 x 30,0	3	Bäcker-Maß	



83403

## Tablett „PURE“

tray  
bandeja  
plateau



	cm	↑ cm	Farbe / Colour
83403	35,5 x 18,0	3	
83417	30,0 x 21,0	3	
83402	53,0 x 18,0	3	



83405

## Tablett quadratisch „PURE“

tray square  
bandeja cuadrada  
plateau carré



	cm	↑ cm	Farbe / Colour
83418	18,0 x 18,0	3	
83407	21,0 x 21,0	3	
83406	26,5 x 26,5	3	
83405	37,0 x 37,0	3	
83404	51,0 x 51,0	3	



**Tablett / Teller „PURE“**

tray / plate  
bandeja / plato  
plateau / assiette



	Ø cm	↑ cm	Farbe / Colour
83884	31	2,5	White
83869	38	2,5	White
83484	51	2,5	White



**Teller, rund „CASUAL“**

plate, round  
plato, redondo  
assiette, ronde



	Ø cm	↑ cm	Farbe / Colour
83500	22,5	2,5	White
83514	26,5	2,5	White



**Schale „PURE“**

bowl  
cuenco  
bol



	Ø cm	↑ cm	ltr.	Farbe / Colour
83450	5,5	4,0	0,02	White
83419	9,0	4,5	0,09	White
83453	13,0	6,5	0,30	White
83455	15,0	7,5	0,45	White
83415	20,0	10,5	1,25	White
	Ø cm	↑ cm	ltr.	Farbe / Colour
83451	5,5	4,0	0,02	Black
83452	9,0	4,5	0,09	Black
83454	13,0	6,5	0,30	Black



**Schale „PURE“**

bowl  
cuenco  
bol



	cm	↑ cm	ltr.	Farbe / Colour
84424	6,5 x 6,5	3,0	0,05	White
83414	9,0 x 9,0	4,0	0,14	White
83410	12,5 x 12,5	6,5	0,40	White
83409	19,0 x 19,0	9,0	1,50	White
83408	25,0 x 25,0	12,0	3,80	White
84425	32,0 x 32,0	14,0	8,0	White
	cm	↑ cm	ltr.	Farbe / Colour
84426	6,5 x 6,5	3,0	0,05	Black
83466	9,0 x 9,0	4,0	0,14	Black
83467	12,5 x 12,5	6,5	0,40	Black
83468	19,0 x 19,0	9,0	1,50	Black
83469	25,0 x 25,0	12,0	3,80	Black
84427	32,0 x 32,0	14,0	8,0	Black





Schale „PURE COLOR“

bowl  
cuenco  
bol



	cm	↑ cm	ltr.	Farbe / Colour
85260	19 x 19	9	1,5	sand
85261	25 x 25	12	3,8	sand
85266	19 x 19	9	1,5	olive
85267	25 x 25	12	3,8	olive



Schale „SLATE“

bowl  
cuenco  
bol



	cm	↑ cm	ltr.
84244	19 x 19	9	1,5
84245	25 x 25	12	3,8

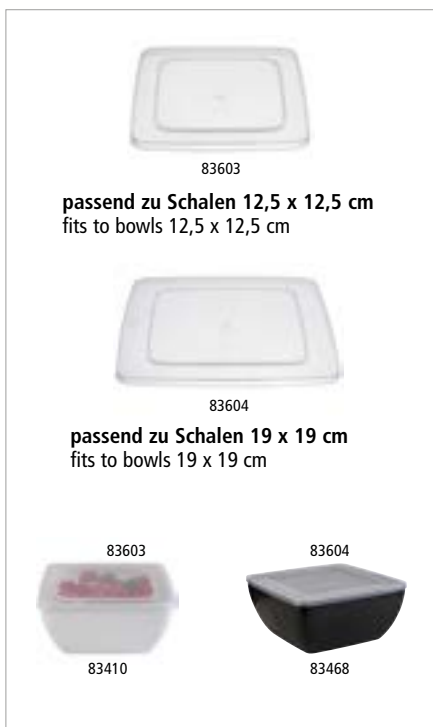

Deckel „PURE“, 5er Set

cover, 5 pcs.  
tapa, set de 5  
couvercle, set de 5



Hygienischer Schutz für Ihre Speisen

- dichtschießend
- schwappsicherer Transport

protection for your food

- tightly closing
- slosh-proof transport

protección de alimentos

- con cierre hermético
- transporte sin salpicaduras

protection des aliments

- fermeture hermétique
- transport sans éclaboussures

	cm	↑ cm	pcs.	fits to
83603	13,0 x 13,0	0,5	5	79002, 79003, 83410, 83467
83604	19,5 x 19,5	0,5	5	79004, 79005, 83409, 83468, 84244, 84830, 85260, 85266



**Deckel „PURE“ mit Löffelaussparung**  
 cover with notched for spoons  
 tapa con espacio para la cuchara  
 couvercle avec encoche pour la louche



	cm	↑ cm	fits to
83600	19 x 19	1,5	84409, 84417, 84422, 83409, 83468, 83572, 83573
83601	25 x 25	1,5	84408, 84418, 84423, 84430, 83575, 83574, 83469, 83408



mit Deckel stapelbar  
 stackable with cover



**Schale „PURE“**  
 bowl  
 cuenco  
 bol



	cm	↑ cm	litr.
83498	38,5 x 15,5	7,5	1,50
83499	51,0 x 15,5	7,5	2,40



**Tablett**  
 tray  
 bandeja  
 plateau



**Edelstahl matt poliert, passend für 2 Melamin-Schalen**  
 stainless steel matt polished, for 2 melamine bowls  
 acero inoxidable pulido mate, para 2 cuencos de melamina  
 acier inox poli mat, pour 2 bols de mélamine

	cm
30120	20 x 11

**Edelstahl matt poliert, passend für 6 Melamin-Schalen**  
 stainless steel matt polished, for 6 melamine bowls  
 acero inoxidable pulido mate, para 6 cuencos de melamina  
 acier inox poli mat, pour 6 bols de mélamine

	cm
30121	29 x 20

**Schale „PURE COLOR“ / bowl / cuenco / bol**

	cm	↑ cm	litr.	Farbe / Colour
83414	9 x 9	4	0,14	White
83466	9 x 9	4	0,14	Black



**GN Tablett „FRAMES“**  
 GN tray  
 GN bandeja  
 GN plateau



	cm	↑ cm	GN
84046	53,0 x 32,5	2	1/1
84047	32,5 x 26,5	2	1/2
84048	32,5 x 17,6	2	1/3

# ENAMEL LOOK



## Teller „ENAMEL LOOK“

plate  
plato  
assiette



	Ø cm	↑ cm	Farbe / Colour
84950	20,5	2,0	
84951	24,5	2,5	



## Schale „ENAMEL LOOK“

bowl  
cuenco  
bol



	cm	↑ cm	litr.	Farbe / Colour
84958	15,0 x 11,5	6,5	0,30	
84959	21,5 x 16,5	9,5	1,00	



## Schale „ENAMEL LOOK“

bowl  
cuenco  
bol



	Ø cm	↑ cm	litr.	Farbe / Colour
84490	5,5	4,0	0,02	
84491	9,5	4,5	0,09	
84492	13,0	6,5	0,30	

# CASUAL



## Schälchen „CASUAL MINI“

bowl  
cuenco  
bol mini



	cm	↑ cm	ltr.	Farbe / Colour
83880	6,0	2,5	0,02	White
83881	7,5	3,5	0,05	White



## Schale „CASUAL MAXI“

bowl  
cuenco  
bol



	Ø cm	↑ cm	ltr.	Farbe / Colour
83696	10	4,5	0,15	White
83698	12	5,5	0,25	White
83700	14	6,5	0,50	White
83704	20	9,2	1,80	White
83702	23	10,5	2,50	White

	Ø cm	↑ cm	ltr.	Farbe / Colour
83697	10	4,5	0,15	Black
83699	12	5,5	0,25	Black
83701	14	6,5	0,50	Black
83705	20	9,2	1,80	Black
83703	23	10,5	2,50	Black

Deckel „FLOAT“ mit Löffelaussparung / cover with notched for spoons / tapa con espacio para la cuchara / couvercle avec encoche pour la louche

	Ø cm	↑ cm	fits to
83920	20,5	1,3	83704, 83705



## Schale „CASUAL“

bowl  
cuenco  
bol



	cm	↑ cm	ltr.
84221	26,5 x 10,5	6,5	1,0



83605 Ø 8 cm

passend zu Schalen Ø 7,5 cm  
fits to bowls Ø 7,5 cm



83606 Ø 14,5 cm

passend zu Schalen Ø 14 cm  
fits to bowls Ø 14 cm



83607 Ø 20,5 cm

passend zu Schalen Ø 20 cm  
fits to bowls Ø 20 cm

### Deckel „CASUAL“, 5er Set

cover, 5 pcs.

tapa, set de 5

couvercle, set de 5



Hygienischer Schutz für Ihre Speisen

dichtschließend, schwappsicherer Transport

protection for your food

tightly closing, slosh-proof transport

protección de alimentos, con cierre hermético, transporte sin salpicaduras

protection des aliments

fermeture hermétique, transport sans éclaboussures

	Ø cm	↑ cm	fits to	pcs.
83605	8,0	0,5	11866, 83881, 15400, 15416, 15461, 15462, 15467, 40655, 40656	5
83606	14,5	0,5	11865, 83700, 83701, 85104, 85105, 85107	5
83607	20,5	0,5	83704, 83705, 15404, 15420	5



stapelbar  
stackable



84215



84216

### Schale „CASUAL“

bowl

cuenco

bol



	Ø cm	↑ cm	ltr.	Farbe / Colour
84215	10	6,5 / 8,5	0,2	—
84216	12	7,5 / 9,5	0,3	—



### Schale „CASUAL“

bowl

cuenco

bol



	Ø cm	↑ cm	ltr.	Farbe / Colour
84295	10	7	0,13	—



### Dipschale „CASUAL“

dip tray

bandeja para dips

plateau pour dips



	cm	↑ cm	Farbe / Colour
84220	29 x 9	3	—



83782



83798



83777

### Dipschälchen „CASUAL“

dip bowl

cuenco para dip

ramequin



	Ø cm	↑ cm	ltr.	Farbe / Colour	VE / unit
83780	6,0	4,0	0,05	—	24
83781	7,5	4,0	0,07	—	24
83782	8,0	4,5	0,08	—	24
83783	8,5	4,5	0,12	—	24
83798	6,0	4,0	0,05	—	24
83777	6,0	3,5	0,04	—	24

## NATURAL COLLECTION



### Blattschale „NATURAL COLLECTION“ leaf fuente en forma de hoja plateau feuille



	cm	↑ cm	Farbe / Colour
83438	45 x 24	3,0	
83441	53 x 29	3,5	

	cm	↑ cm	Farbe / Colour
83437	36 x 16	3,0	
83440	45 x 24	3,0	
83443	53 x 29	3,5	

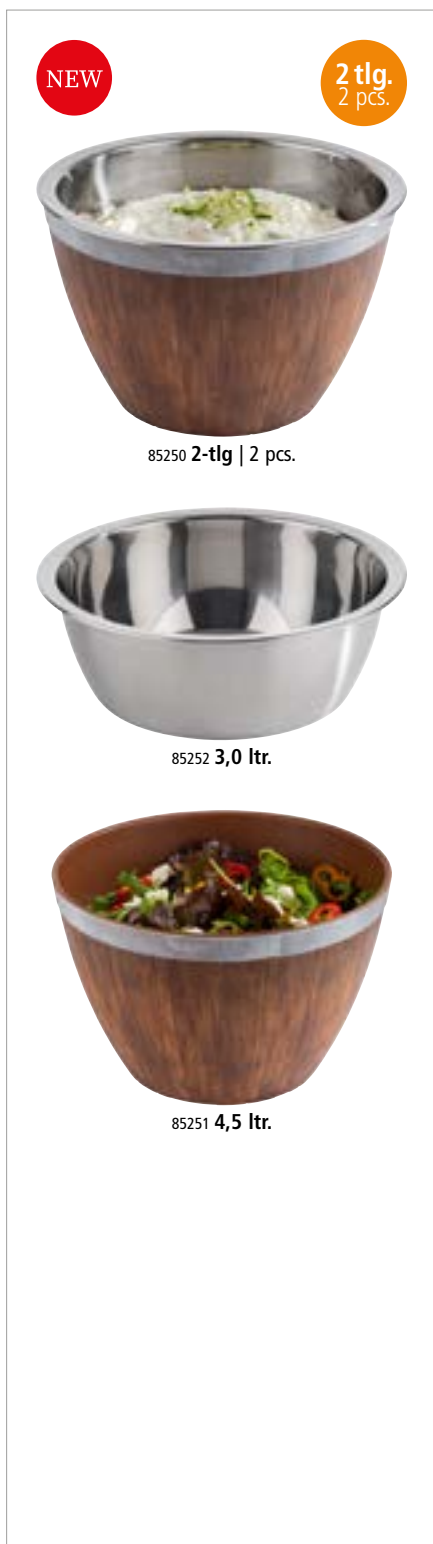

### Fass, 2-teilig bowl cuenco bol



**2-teilig: Unterteil / Edelstahlschale**  
2 pcs.: lower part / stainless steel bowl  
set de 2: parte inferior / cuenco de acero inoxidable  
set de 2: partie inférieure / bol en acier inox

	Ø cm	↑ cm
85250	26	16

#### Unterteil / lower part / parte inferior / partie inférieure

	Ø cm	↑ cm	ltr.
85251	25	16	4,5

#### Edelstahlschale / stainless steel bowl / cuenco de acero inoxidable / bol en acier inox

	Ø cm	↑ cm	ltr.
85252	26	9	3,0



**Unterteil mit Eis füllen für perfekte Kühlung sensibler Speisen**  
fill the bottom part with ice for perfect cooling of sensitive dishes

## BRÖTCHENSCHÜTTE



85140



85140



85141



85141

## Tablett „BRÖTCHENSCHÜTTE“

tray  
bandeja  
plateau

	cm	↑ cm	Farbe / Colour
85140	41 x 18	3,0	
85141	41 x 18	3,0	



85140

Griffbereich mit Aufhängeloch  
handle area with hanging holeHolzoptik  
wood look

85141

Schieferoptik  
slate lookPräsentationsmöglichkeit  
presentation example



**Schale, 2-teilig „FRIDA“**

bowl, 2 pcs.  
cuenco, set de 2  
bol, set de 2



inklusive Abtropfeinsatz  
including drip tray  
con bandeja recogeotas  
avec égouttoir

	Ø cm	↑ cm
85230	25,5	6
85231	33,0	6

**Buffetständer, mit schwarzer Antirutschbeschichtung, für Schalen Nr. 85230, 85231**

buffet stand, with black anti-slide coating, for bowls no. 85230, 85231  
soporte para buffet, con revestimiento antideslizante negro, para cuencos 85230, 85231  
présentoir buffet, avec revêtement antidérapant noir, pour bols 85230, 85231

	Ø cm	↑ cm
33282	23 / 30,5	17



Präsentationsmöglichkeit  
presentation example



**Servier- und Tortenplatte „CASUAL“**

cake plate  
porta pasteles  
présentoir à gâteaux



	Ø cm	↑ cm
83890	31	8
83891	31	16



**Servier- und Tortenplatte „CASUAL“**

cake plate  
porta pasteles  
présentoir à gâteaux



	cm	↑ cm
83892	31 x 31	8
83893	31 x 31	16



**Torten- / Konditorplatte**

cake stand  
soporte para pastel  
présentoir à gâteaux



Rand fixiert die Haube, mit Antirutsch-Füßchen  
carved edge fixes the cover, with non-slip feet  
ranura para fijar bien la campana, con pies antideslizantes  
bord rainuré pour maintenir ferme la cloche, avec pieds antidérapants

	Ø cm	↑ cm	Farbe / Colour
00468	31,0	3,5	White
00469	31,0	3,5	Black





## Schale „BALANCE“

bowl  
cuenco  
bol

	Ø cm	↑ cm	ltr.	Farbe / Colour
84040	14,5	9,0	0,4	White
84041	21,0	13,0	1,5	White
84042	24,5	15,0	2,5	White
84043	30,0	19,5	5,0	White

	Ø cm	↑ cm	ltr.	Farbe / Colour
85040	14,5	9,0	0,4	Black
85041	21,0	13,0	1,5	Black
85042	24,5	15,0	2,5	Black
85043	30,0	19,5	5,0	Black

## Buffetständer „KING“ / buffet stand / soporte para buffet / présentoir buffet

	Ø cm	↑ cm
03622	15	14
03623	15	21



## Tablett / Teller

tray / plate  
bandeja / plato  
plateau / assiette

	Ø cm	↑ cm	Farbe / Colour
83869	38	2,5	White

## Rolltophaube mit verchromtem Kugelgriff

rolltop cover with chrome plated handle  
campana abatible con pomo cromado  
cloche basculante avec bouton chromé

	Ø cm	↑ cm
18388	38	20



## Frischhalte-Haube

cover  
campana  
cloche

	Ø cm	↑ cm
06510	30	11,5

mit verchromtem Griff / with chrom plated handle / con botón cromado / avec bouton chromé

	Ø cm	↑ cm
06512	30	11,5

## CUTLERY REST



**Besteckablage „SMALL WAVE“**  
cutlery rest  
reposa cuchara  
pose-cuillère



MAX  
70°C



	cm	↑ cm
83897	26 x 13	4,5



**Besteckablage „BOWL“**  
cutlery rest  
reposa cuchara  
pose-cuillère



MAX  
70°C



	cm	↑ cm	ltr.
83803	22,5 x 11	6	0,5



**Besteckablage „SPOON“**  
cutlery rest  
reposa cuchara  
pose-cuillère



MAX  
70°C



	cm	↑ cm
83801	26 x 10,5	5



**Servierlöffel „PROFI“**  
serving spoon  
cuchara para servir  
cuillère de service



MAX  
70°C



	cm	→ cm	Farbe / Colour
84020	7 x 6,5	26,5	
84021	7 x 6,5	26,5	



**Salatlöffel**  
salad spoon  
cuchara para ensalada  
cuillère à salade



MAX  
70°C



	cm	→ cm
84035	8 x 7	24



**Eierbecher, 4er Set**  
egg holder, 4 pcs. set  
huevera, set de 4  
coquetier, set de 4



MAX  
70°C



	Ø cm	↑ cm	pcs.
83851	8	3	4
83848	8,5	2	4

# FINGERFOODLÖFFEL



## Fingerfoodlöffel „HALFTONE“

party spoon  
cuchara party  
cuillère party



	Ø cm	↑ cm	VE / unit
84158	5,5	7	24



## Fingerfoodlöffel „HALFTONE“

party spoon  
cuchara party  
cuillère party



	cm	↑ cm	VE / unit
84128	14,5 x 4,5	4,5	12



## Fingerfoodlöffel „LEAF“

party spoon  
cuchara party  
cuillère party



	cm	↑ cm	Farbe / Colour	VE / unit
83889	10 x 4,5	1,5		50
83887	10 x 4,5	1,5		50
83888	10 x 4,5	1,5		50



## PARTY SPOON



### Fingerfoodlöffel „HONG KONG“

party spoon  
cuchara party  
cuillère party



MAX  
70°C



	cm	↑ cm	Farbe / Colour	VE / unit
83486	13 x 4,5	4,5		60
83487	13 x 4,5	4,5		60
83424	13 x 4,5	4,5		60
83426	13 x 4,5	4,5		60



### Fingerfoodlöffel „MING HING“

party spoon  
cuchara party  
cuillère party



MAX  
70°C



	cm	↑ cm	Farbe / Colour	VE / unit
83842	11 x 4,5	4		60
83843	11 x 4,5	4		60



### Schale „MINI“

bowl  
cuenco  
bol



MAX  
70°C



	cm	↑ cm	ltr.	VE / unit
84460	35 x 4,5	3	0,20	10



### Schale, rund „TAO“

bowl, round  
cuenco, redondo  
bol, rond



MAX  
70°C



	cm	↑ cm	ltr.	Farbe / Colour
83648	10,5 x 10,0	6,5 / 3,0	0,07	
83649	10,5 x 10,0	6,5 / 3,0	0,07	



**Schale „MINI“**  
bowl  
cuenco  
bol



	cm	↑ cm	ltr.	Farbe / Colour	VE / unit
84750	8 x 8	3	0,06		24



**Dipschälchen „APART“**  
dip bowl  
cuenco para dip  
ramequin



	Ø cm	↑ cm	ltr.	Farbe / Colour
83800	6,5	3,0	0,045	



**Dipschälchen „APART“**  
dip bowl  
cuenco para dip  
ramequin



	cm	↑ cm	ltr.	Farbe / Colour
83808	6,5 x 6,5	3,0	0,05	



**Dipschälchen „FLOWER POT“**  
dip bowl  
cuenco para dip  
ramequin



	Ø cm	↑ cm	ltr.	Farbe / Colour
84470	6	3,5	0,04	
84471	6	3,5	0,04	
84472	6	3,5	0,04	



**Dipschälchen, 6er Set**  
dip bowl, 6 pcs.  
cuenco para dip, set de 6  
ramequin, set de 6



	Ø cm	↑ cm	ltr.	Farbe / Colour	pcs.
85240	6	4	0,04		6
85241	6	4	0,04		6
85242	6	4	0,04		6
85243	6	4	0,04		6
85244	6	4	0,04		6



Teller „MINI“

plate  
plato  
assiette



	cm	↑ cm	ltr.	VE / unit
84444	10,5 x 8,5	2,0	0,07	20

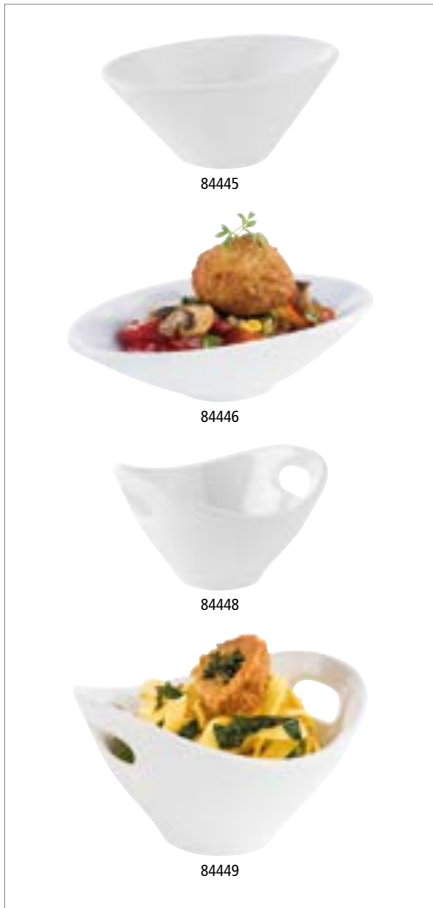

Schale „MINI“

bowl  
cuenco  
bol



	cm	↑ cm	ltr.	VE / unit
84445	10,5 x 6,0	4,0	0,07	20
84446	13,5 x 7,5	3,0	0,07	20
84448	9,5 x 9,0	5,5	0,09	20
84449	13,0 x 12,0	7,5	0,18	20



Schale „MINI“

bowl  
cuenco  
bol



	cm	↑ cm	ltr.	VE / unit
84452	11,5 x 7,5	3,0	0,06	24
84454	11,5 x 6,0	5,5	0,04	24
84456	8,5 x 7,0	6,0	0,07	24
84458	8,0 x 8,0	4,0	0,10	24
84450	7,5 x 7,0	4,5	0,05	24



**Schale „MINI“**  
bowl  
cuenco  
bol



	Ø cm	↑ cm	ltr.	Farbe / Colour
84775	8,5	2,5	0,07	White
84778	8,5	2,5	0,07	Black
84781	8,5	2,5	0,07	Grey



**Schale „MINI“**  
bowl  
cuenco  
bol



	Ø cm	↑ cm	ltr.	Farbe / Colour
84776	8,5	2,5	0,07	White
84779	8,5	2,5	0,07	Black
84782	8,5	2,5	0,07	Grey



**Schale „MINI“**  
bowl  
cuenco  
bol



	cm	↑ cm	ltr.	Farbe / Colour
84777	9,5 x 5,5	5,5	0,07	White
84780	9,5 x 5,5	5,5	0,07	Black
84783	9,5 x 5,5	5,5	0,07	Grey

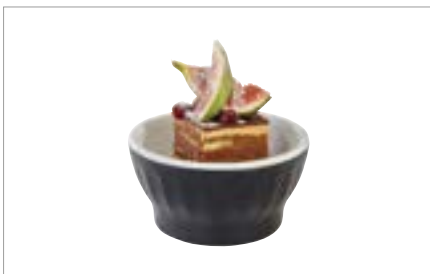

**Schale „HALFTONE“**  
bowl  
cuenco  
bol



	Ø cm	↑ cm	ltr.	VE / unit
84217	8,0	4,0	0,1	12



**Dipschälchen „GOURMET“**  
dip bowl  
cuenco para dip  
ramequin

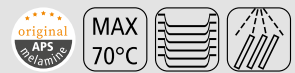

	Ø cm	↑ cm	ltr.
84018	7	6	0,05

# GN CONTAINERS



## GN-Behälter „HIGHLINE“

GN container  
GN cubeta  
GN bac



**extrem bruchsicher, glänzende und harte Oberfläche, tiefkühlfest, keinen Temperaturschocks unterziehen, nicht auf heißen Flächen liegen lassen, mit Stapelnocke**

durable, top quality, hard and glossy surface, avoid thermal shocks, do not leave on hot surfaces, with notching edge

duradera, alta calidad, superficie brillante y resistente, hay que evitar los cambios térmicos bruscos, no apoyar en superficies calientes, con borde para apilamiento

durable, haute qualité, surface brillante et résistante, éviter les chocs thermiques et ne pas poser sur une surface chaude, encoche pour une louche

	GN	↓ mm	ltr.	cm
83772	1/1	65	7,10	53,0 x 32,5
83768	1/2	65	3,40	32,5 x 26,5
83766	2/4	65	3,00	53,0 x 16,2
83764	1/3	65	2,00	32,5 x 17,6
83762	1/4	65	1,35	26,5 x 16,2
83760	1/6	65	0,80	17,6 x 16,2

	GN	↓ mm	ltr.	cm
83773	1/1	100	11,0	53,0 x 32,5
83769	1/2	100	5,50	32,5 x 26,5
83765	1/3	100	3,15	32,5 x 17,6
83763	1/4	100	2,20	26,5 x 16,2
83761	1/6	100	1,25	17,6 x 16,2



83768

stapelbar  
stackable





## GN-Behälter „ECOLINE“

GN container

GN cubeta

GN bac

mit Stapelnocke

with notching edge

con borde marcado para el apilado

avec rebord pour l'empilage



GN 2/4

GN 1/1

GN 1/2

GN 1/4

GN 1/6

	GN	↓ mm	ltr.	cm	Farbe / Colour
83759	1/1	65	7,10	53,0 x 32,5	White
83755	2/4	65	3,00	53,0 x 16,2	White
83757	1/2	65	3,40	32,5 x 26,5	White
83753	1/3	65	2,00	32,5 x 17,6	White
83751	1/4	65	1,35	26,5 x 16,2	White
83749	1/6	65	0,80	17,6 x 16,2	White

	GN	↓ mm	ltr.	cm	Farbe / Colour
83758	1/1	65	7,10	53,0 x 32,5	Black
83754	2/4	65	3,00	53,0 x 16,2	Black
83756	1/2	65	3,40	32,5 x 26,5	Black
83752	1/3	65	2,00	32,5 x 17,6	Black
83750	1/4	65	1,35	26,5 x 16,2	Black
83748	1/6	65	0,80	17,6 x 16,2	Black

	GN	↓ mm	ltr.	cm	Farbe / Colour
84300	1/1	100	10,6	53,0 x 32,5	White
84302	2/4	100	4,3	53,0 x 16,2	White
84301	1/2	100	4,7	32,5 x 26,5	White
84303	1/3	100	2,7	32,5 x 17,6	White
84304	1/4	100	1,9	26,5 x 16,2	White
84305	1/6	100	1,0	17,6 x 16,2	White

	GN	↓ mm	ltr.	cm	Farbe / Colour
84306	1/1	100	10,6	53,0 x 32,5	Black
84308	2/4	100	4,3	53,0 x 16,2	Black
84307	1/2	100	4,7	32,5 x 26,5	Black
84309	1/3	100	2,7	32,5 x 17,6	Black
84310	1/4	100	1,9	26,5 x 16,2	Black
84311	1/6	100	1,0	17,6 x 16,2	Black



## GN-Deckel

GN-lid

GN tapa

GN couvercle



	GN	cm
82001	1/1	53,0 x 32,5
82013	1/2	32,5 x 26,5
82019	1/3	32,5 x 17,6
82029	1/4	26,5 x 16,2
82037	1/6	17,6 x 16,2





# Tableware

## Table Presentation

LEVANTE .....	228
SERVING TROWELS.....	230
CAST IRON.....	231
SERVING POTS.....	232
SNACKHOLDERS .....	234
DIP BOWLS .....	238
PARTY SPOONS .....	240
BOWLS   WOOD .....	241
SERVING BOARDS   WOOD.....	243
SERVING BOARDS   NATURAL SLATE....	249
TRAYS   BOARDS.....	251
SALT- / PEPPER MILLS.....	252
MENAGES .....	259
SUGAR DISPENSERS.....	267
BUTTER DISHES   EGG HOLDERS.....	270
FONDUE   CAVIAR COOLER   SKEWER....	271
TABLE CADDYS .....	272
CANDLE HOLDERS.....	274
FLOWER VASES.....	275
PLACEMATS.....	276
ENAMELWARE .....	279
GLASSES.....	281
SEAFOOD.....	287
CAKE STANDS.....	288
SUPER DOME.....	290
GRAVY BOATS.....	291
PLATE TRAYS.....	292
COASTERS.....	293
CUTLERY BINS   WASTE BINS.....	294
MENU HOLDERS.....	297
TO GO CUP .....	305

# LEVANTE



Levante Küche passend serviert! Viel Gemüse, wenig Fleisch und eine Vielfalt an Gewürzen charakterisieren die Küche des Nahen Ostens. Der östliche Mittelmeerraum, also Syrien, Libanon, Jordanien, Israel und Palästina wird als Levante bezeichnet. Als Levante-Küche wird die Essenstradition dieser Länder als Food-Trend gefeiert.

Levantine cuisine served appropriately! Lots of vegetables, little meat and a variety of spices characterise the cuisine of the Middle East. The eastern Mediterranean region, i. e. Syria, Lebanon, Jordan, Israel and Palestine is referred to as the Levant. As Levantine cuisine, the food tradition of these countries is celebrated as a food trend.

Cocina levantina servida como es debido. Mucha verdura, poca carne y una gran variedad de especias caracterizan la cocina de Oriente Medio. La región del Mediterráneo oriental, es decir, Siria, Líbano, Jordania, Israel y Palestina, se denomina Levante. La cocina levantina, la tradición alimentaria de estos países, se celebra como una tendencia alimentaria.

Cuisine levantine servie comme il se doit! Beaucoup de légumes, peu de viande et une variété d'épices caractérisent la cuisine du Moyen-Orient. La région de la Méditerranée orientale, c'est-à-dire la Syrie, le Liban, la Jordanie, Israël et la Palestine, est appelée le Levant. La tradition alimentaire de ces pays, la cuisine levantine, est célébrée comme une tendance alimentaire.



## Flaschenkühler „LEVANTE“

bottle cooler  
enfriador de botella  
rafraîchisseur de bouteille

doppelwandig für beste Isolierung, für 0,7 - 1,5 Liter-Flaschen

double wall cooler keeps the temperature for a long time, for 0,7 - 1,5 ltr. bottles

doble pared para mantener el frío largo tiempo, para botellas de 0,7 - 1,5 ltr.

double paroi pour une meilleure conservation de la température, pour bouteilles de 0,7 à 1,5 l.

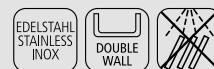

	cm	↑ cm	Farbe / Colour
36125	12 / 10	20	
36127	12 / 10	20	



## Tablett „LEVANTE“

tray  
bandeja  
GN plateau



	cm	↑ cm	ltr.	Farbe / Colour
40712	26,5 x 16	3	0,70	
40713	26,5 x 16	3	0,70	



Präsentationsmöglichkeit  
presentation example



Schale „LEVANTE“

bowl  
cuenco  
bol



	Ø cm	↑ cm	ltr.	Farbe / Colour
40700	9,5	4,5	0,14	
40701	9,5	4,5	0,14	
40702	12	6,5	0,32	
40703	12	6,5	0,32	
40704	17	8,5	0,90	
40705	17	8,5	0,90	



stapelbar  
stackable

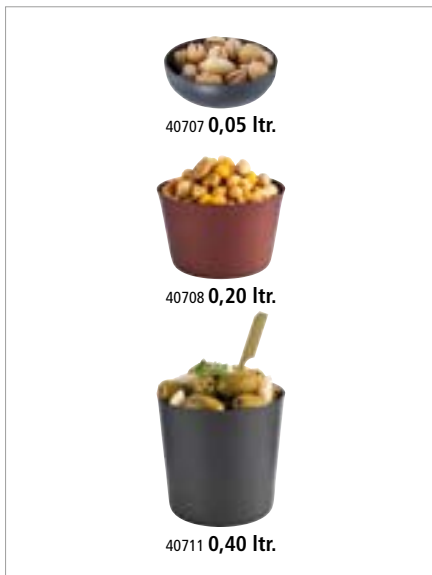

Schale „LEVANTE“

bowl  
cuenco  
bol



	Ø cm	↑ cm	ltr.	Farbe / Colour
40706	7,5	2,5	0,05	
40707	7,5	2,5	0,05	
40708	8,5	5,5	0,20	
40709	8,5	5,5	0,20	
40710	8,5	8,5	0,40	
40711	8,5	8,5	0,40	

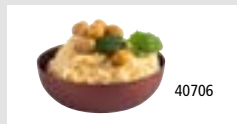

40706

Präsentationsmöglichkeit  
presentation example

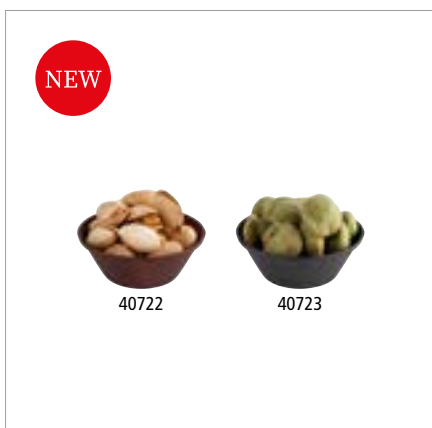

Dipschälchen, 6er Set „LEVANTE“

dip bowl, 6 pcs.  
cuenco para dip, set de 6  
ramequin, set de 6



	Ø cm	↑ cm	ltr.	Farbe / Colour	pcs.
40722	6,0	2,5	0,04		6
40723	6,0	2,5	0,04		6



40723

00754

Präsentationsmöglichkeit  
presentation example

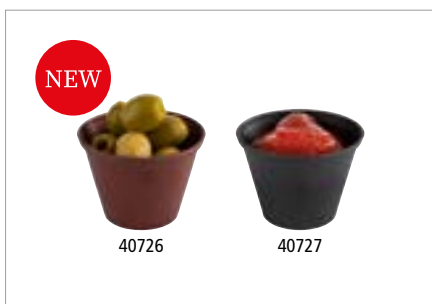

Dipschälchen, 6er Set „LEVANTE“

dip bowl, 6 pcs.  
cuenco para dip, set de 6  
ramequin, set de 6



	Ø cm	↑ cm	ltr.	Farbe / Colour	pcs.
40726	6,0	4,5	0,06		6
40727	6,0	4,5	0,06		6

# SERVING TROWEL *super trendy*



## Servierkelle „BOB“

serving trowel  
paleta para servir  
truelle de service



**Edelstahl Servierkelle mit schwarzem Holzgriff**

stainless steel serving trowel with black wooden handle  
paleta para servir de acero inoxidable con mango de madera negra  
truelle de service en acier inox avec manche en bois noir

	cm	↑ cm	Griff / handle cm	
40680	23,5 x 15,5	12,5	13,5	stainless steel
40681	23,5 x 15,5	12,5	13,5	■

## Snackbox „INDUSTRIAL“

snack box  
caja tentempié  
casse-croûte



**Metall, schwarz**

metal, black  
metal, negro  
métal, noir

	cm	↑ cm	ltr.
40676	23,0 x 15,5	13,0	2,4



stapelbar  
stackable

# CAST IRON



Die Servierpfännchen aus emailiertem Gusseisen dienen dem portionsweisen Servieren und halten die Speisen warm.

The serving pans made of enameled cast iron are used for serving in portions and for keeping the food warm.

Las fuentes de hierro fundido esmaltado se utilizan para servir en porciones y mantener la comida caliente.

Les plateaux de service en fonte émaillée sont utilisés pour servir en portions et garder les aliments au chaud.

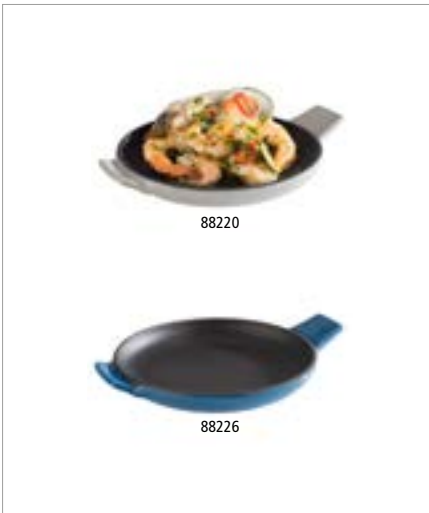

88220

88226

## Servierpfännchen „CAST IRON“

serving pan  
fuente para servir  
plat de service

Gusseisen emailiert  
enameled cast iron  
hierro fundido esmaltado  
fonte émaillée



	Ø cm	↑ cm	Farbe / Colour
88220	10	2	Grey
88225	10	2	Blue
88221	13	2	Grey
88226	13	2	Blue



88222

88229

## Servierpfännchen „CAST IRON“

serving pan  
fuente para servir  
plat de service

Gusseisen emailiert  
enameled cast iron  
hierro fundido esmaltado  
fonte émaillée



	cm	↑ cm	Farbe / Colour
88222	13 x 13	2	Grey
88227	13 x 13	2	Blue
88223	16 x 13	2	Grey
88228	16 x 13	2	Blue
88224	20 x 13	2	Grey
88229	20 x 13	2	Blue



00813

Servierbeispiel  
serving example

00812



NEW

## MUMBAI

NEW



40730 0,30 ltr.



40731 0,35 ltr.



40732 0,60 ltr.

## Serviertöpfchen „MUMBAI“

small serving pot  
olla pequeña de servir  
marmite petite de servir



Edelstahl, außen: Kupfer-Look, gehämmerte Oberfläche, Griffe vergoldet  
stainless steel, outside: copper look, hammered surface, handles gold-plated  
acero inoxidable, exterior: look cobre, superficie martillada, asas doradas  
acier inox, extérieur: look cuivre, surface martelée, poignées dorées

	Ø cm	↑ cm	ltr.	Griff / handle cm
40730	9,0	5,5	0,30	2,25
40731	11,5	4,5	0,35	2,00
40732	11,5	7,0	0,60	2,25
40733	14,0	5,0	0,50	1,75
40734	16,0	5,0	0,70	1,75

NEW



40735 0,25 ltr.



40736 0,45 ltr.

## Mini-Servierpfanne „MUMBAI“

small serving pan  
olla pequeña de servir  
marmite petite de servir



Edelstahl, außen: Kupfer-Look, gehämmerte Oberfläche, Griffe vergoldet  
stainless steel, outside: copper look, hammered surface, handles gold-plated  
acero inoxidable, exterior: look cobre, superficie martillada, asas doradas  
acier inox, extérieur: look cuivre, surface martelée, poignées dorées

	cm	↑ cm	ltr.	Griff / handle cm
40735	12,5 x 8,5	4,0	0,25	2,0
40736	14,5 x 9,5	4,5	0,45	2,0

NEW



40737 0,15 ltr.



40738 0,20 ltr.

## Schale „MUMBAI“

bowl  
cuenco  
bol



Edelstahl, außen: Kupfer-Look, gehämmerte Oberfläche, Griffe vergoldet  
stainless steel, outside: copper look, hammered surface, handles gold-plated  
acero inoxidable, exterior: look cobre, superficie martillada, asas doradas  
acier inox, extérieur: look cuivre, surface martelée, poignées dorées

	Ø cm	↑ cm	ltr.
40737	8,5	4,5	0,15
40738	9,0	5,0	0,20



NEW



40740 0,6 ltr.



40741 0,3 ltr.



40742 0,5 ltr.

**Serviertöpfchen**

small serving pot  
olla pequeña de servir  
marmite petite de servir

**Aluminium anthrazit, Griffe aus Messing**

aluminium anthracite, brass handles

aluminio antracita, asas de latón

aluminium anthracite, poignées en laiton



	Ø cm	↑ cm	ltr.	Griff / handle cm
40740	11,5	9,5	0,6	2,5
40741	13,5	5,0	0,3	3,5
40742	15,0	6,0	0,5	2,5

**Mini-Servierpfanne „SNACKHOLDER“**

mini pan  
sartén en formato mini  
poêle à frire mini



	cm	↑ cm	ltr.
40660	14,5 x 9,5	4,5 / 6,5	0,5



40186 0,30 ltr.



40187 0,55 ltr.



40188 0,75 ltr.

**Serviertöpfchen „MUMBAI“**

small serving pot  
olla pequeña de servir  
marmite petite de servir

**gehämmerte Oberfläche**

hammered surface

superficie martillada

surface martelée



	Ø cm	↑ cm	ltr.	Griff / handle cm
40186	9,5	5,5	0,30	2,5
40187	13,5	5,0	0,55	3,0
40188	15,5	5,0	0,75	3,0



40642 0,05 ltr.



40643 0,12 ltr.



40644 0,32 ltr.

**Stielkasserolle / Serviertopf**

sauté pan / mini sauce pan  
cazo recto bajo  
plat à sauter

**hochglanzpoliert**

mirror polished

pulido brillante

poli brillant



	Ø cm	↑ cm	ltr.	Griff / handle cm
40642	5,5	2,5	0,05	6
40643	7,0	3,5	0,12	8,5
40644	9,5	5,5	0,32	8,5

# SNACKHOLDER



Die Mini-Edelstahlkörbchen dienen dem portionsweisen Servieren. Zum originellen Servieren von Beilagen geeignet, aber auch zum Frittieren selbst.

The mini frying baskets are used to present individual portions in an original way, but can still be used to fry.

Las mini cestas para freír se utilizan para presentar las porciones individuales de forma original, pero pueden seguir utilizándose para freír.

Les paniers à friture offrent une présentation originale pour servir apéritifs, snacks, tapas et autres rations individuelles. Également aptes pour frire.



## Servier-Frittierkorb „SNACKHOLDER“

stainless steel fry baskets  
cestitas inox para el servicio mesa  
paniers inox pour le service sur table



	Ø cm	↑ cm	Griff / handle cm	Farbe / Colour	
40600	8	7,5	9,5		stainless steel
40602	8	7,5	9,5		gold
40624 <small>NEW</small>	8	7,5	9,5		black mat
40601	9	8,5	9,0		stainless steel
40603	9	8,5	9,0		gold
40625 <small>NEW</small>	9	8,5	9,0		black mat



## Servier-Frittierkorb „SNACKHOLDER“

stainless steel fry baskets  
cestitas inox para el servicio mesa  
paniers inox pour le service sur table



	cm	↑ cm	Griff / handle cm	Farbe / Colour	
40610	21,5 x 10,5	4,5	9,5		stainless steel
40612	21,5 x 10,5	4,5	9,5		gold
40628 <small>NEW</small>	21,5 x 10,5	4,5	9,5		black mat
40611	26,0 x 13,0	5,0	9,0		stainless steel
40613	26,0 x 13,0	5,0	9,0		gold
40629 <small>NEW</small>	26,0 x 13,0	5,0	9,0		black mat



## Servier-Frittierkorb „SNACKHOLDER“

stainless steel fry baskets  
cestitas inox para el servicio mesa  
paniers inox pour le service sur table



	cm	↑ cm	Griff / handle cm	Farbe / Colour	
40620	10,0 x 8,5	6,5	9,0		stainless steel
40622	10,0 x 8,5	6,5	9,0		gold
40626 <small>NEW</small>	10,0 x 8,5	6,5	9,0		black mat
40621	13,0 x 10,5	9,0	13,5		stainless steel
40623	13,0 x 10,5	9,0	13,5		gold
40627 <small>NEW</small>	13,0 x 10,5	9,0	13,5		black mat



**Snackholder**  
serving cup  
vaso para servir  
gobelet à apéritif



	Ø cm	↑ cm	ltr.	Farbe / Colour
40606	8,5	8,5	0,35	stainless steel
40617	8,5	8,5	0,35	stainless copper
40607	8,5	8,5	0,35	hammered surface
40618	8,5	8,5	0,35	hammered surface
40605	9,5	8,5 / 11,5	0,45	stainless steel
40616	9,5	8,5 / 11,5	0,45	stainless copper

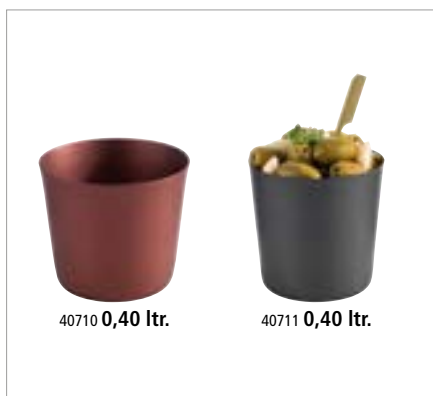

**Schale „LEVANTE“**  
bowl  
cuenco  
bol



	Ø cm	↑ cm	ltr.	Farbe / Colour
40710	8,5	8,5	0,40	red
40711	8,5	8,5	0,40	dark grey



**Servier- / Saucen-Eimer „SNACKHOLDER“**

mini stainless steel bucket  
cubo inox en formato mini  
seau mini inox  
hochglanzpoliert  
mirror polished  
pulido brillante  
poli brillant



	Ø cm	↑ cm	ltr.	pcs.
40630	7	6,5	0,15	4
40631	9	8,5	0,33	1



**Mini-Milchkanne „SNACKHOLDER“ 4er Set**

mini milk can, 4 pcs.  
lechera en formato mini, set de 4  
pot à lait mini, set de 4



	Ø cm	↑ cm	ltr.	pcs.
40640	4,5	5	0,08	4

## SNACKHOLDERS



40654 **0,12 ltr.**

40656 **0,35 ltr.**

40659 **0,80 ltr.**

40657 **1,30 ltr.**

40658 **1,80 ltr.**

### Snackcan

serving can  
lata para aperitivos  
boîte de conserves pour apéritifs

**matt poliert**  
matt polished  
pulido mate  
poli mat



	Ø cm	↑ cm	ltr.	
40654	6,5	4,0	0,12	ideale Beilagen Größe
40655	7,5	5,5	0,17	
40656	7,5	10,0	0,35	
40659	12,0	8,0	0,80	
40658	13,5	14,0	1,80	
40657	13,5	10,5	1,30	

Wachspapier „SNACKHOLDER“ / greaseproof paper squares  
papel alimenticio para cucurucho / papier alimentaire pour cornet

	cm	pcs.	Motiv: Zeitung
40670	42 x 25	500	



Präsentationsmöglichkeit  
presentation example



40685 **0,05 ltr.**

40686 **0,17 ltr.**

### Schale

bowl  
cuenco  
bol  
**hochglanzpoliert**  
mirror polished  
pulido brillante  
poli brillant



	Ø cm	↑ cm	ltr.
40685	6	3,0	0,05
40686	8	4,5	0,17



**0,15 ltr.**

### Schale "MUMBAI"

bowl  
cuenco  
bol  
**gehämmerte Oberfläche**  
hammered surface  
superficie martillada  
surface martelée



	Ø cm	↑ cm	ltr.
40185	9,5	3	0,15



40690 0,7 ltr.



40691 0,7 ltr.



40692 0,7 ltr.



40693 1,4 ltr.



40694 1,4 ltr.



40695 1,4 ltr.

Schale  
bowl  
cuenco  
bol

gehämmerte Oberfläche  
hammered surface  
superficie martillada  
surface martelée



	Ø cm	↑ cm	ltr.	Farbe / Colour	
40690	15,5 x 12,0	5,5	0,7		gold look
40691	15,5 x 12,0	5,5	0,7		copper look
40692	15,5 x 12,0	5,5	0,7		gunmetal-look
40693	23,0 x 15,5	6,0	1,4		gold look
40694	23,0 x 15,5	6,0	1,4		copper look
40695	23,0 x 15,5	6,0	1,4		gunmetal-look



Präsentationsmöglichkeit  
presentation example



40604

Servierkorb „BURGER & FRIES“

serving basket  
cesta para servir  
corbeille de service

Servierkorb aus Metall mit 2 Haltern für Dipschälchen

metal serving basket with 2 holders for dip bowls

cesta de metal para servir con 2 soportes para cuencos para dip

corbeille de service en métal avec 2 supports pour ramequins



	cm	↑ cm
40604	39,5 x 20	11

passende Schälchen / suitable bowls / cuencos adecuados / bols appropriés



	Ø cm	↑ cm	ltr.	VE / unit
83781	7,5	4	0,07	24



83781

Servierbeispiel - Lieferung ohne Schälchen  
delivery without bowls



Präsentationsmöglichkeit  
presentation example

# DIP BOWLS



Ob Nachos mit Käsedip, Gemüsesticks mit Joghurtsoße oder eine Käseplatte mit Feigensenf: All diese Köstlichkeiten finden in Dipschalen ihren Platz und regen den Appetit Ihrer Gäste an.

Whether nachos with cheese dip, vegetable sticks with yoghurt sauce or cheese platter with fig mustard: all these delicacies find their place in dip bowls and stimulate the appetite of your guests.

Ya sean nachos con dip de queso, palitos de verdura con salsa de yogur o tabla de quesos con mostaza de higos: todas estas delicias encuentran su lugar en los cuencos para dip y estimulan el apetito de sus invitados.

Qu'il s'agisse de nachos avec trempette au fromage, de bâtonnets de légumes avec sauce au yaourt ou d'un plateau de fromage avec moutarde aux figues : tous ces délices trouvent leur place dans les bols à trempette et stimulent l'appétit de vos invités.



## Dipschälchen, 6er Set dip bowl, 6 pcs. cuenco para dip, set de 6 ramequin, set de 6



	Ø cm	↑ cm	ltr.	Farbe / Colour	pcs.
40720	6,0	2,5	0,04		6
40721	6,0	2,5	0,04		6
40722	6,0	2,5	0,04		6
40723	6,0	2,5	0,04		6
40728	6,0	2,5	0,04		6

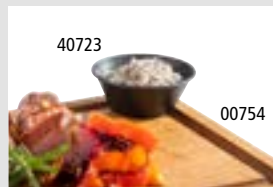

Präsentationsmöglichkeit  
presentation example



## Dipschälchen, 6er Set dip bowl, 6 pcs. cuenco para dip, set de 6 ramequin, set de 6



	Ø cm	↑ cm	ltr.	Farbe / Colour	pcs.
40724	6,0	4,5	0,06		6
40725	6,0	4,5	0,06		6
40726	6,0	4,5	0,06		6
40727	6,0	4,5	0,06		6
40729	6,0	4,5	0,06		6



**Dipschälchen, 12er Set**  
dip bowl, 12 pcs.  
cuenco para dip, set de 12  
ramequin, set de 12



	Ø cm	↑ cm	ltr.	Farbe / Colour	pcs.
40760	6,0	3,5	0,04	—	12
40761	6,0	3,5	0,04	—	12
40762	6,0	3,5	0,04	—	12
40763	7,0	3,5	0,07	—	12
40764	7,0	3,5	0,07	—	12
40765	7,0	3,5	0,07	—	12
40766	7,5	4,0	0,09	—	12
40767	7,5	4,0	0,09	—	12
40768	7,5	4,0	0,09	—	12



**Dipschälchen, 6er Set**  
dip bowl, 6 pcs.  
cuenco para dip, set de 6  
ramequin, set de 6



	Ø cm	↑ cm	ltr.	Farbe / Colour	pcs.
85240	6,0	4,0	0,04	—	6
85241	6,0	4,0	0,04	—	6
85242	6,0	4,0	0,04	—	6
85243	6,0	4,0	0,04	—	6
85244	6,0	4,0	0,04	—	6



**Dipschälchen „FLOWER POT“**  
dip bowl  
cuenco para dip  
ramequin



	Ø cm	↑ cm	ltr.	Farbe / Colour	VE / unit
84470	6,0	3,5	0,04	—	60
84471	6,0	3,5	0,04	—	60
84472	6,0	3,5	0,04	—	60



**Dipschälchen „CASUAL“**  
dip bowl  
cuenco para dip  
ramequin



	Ø cm	↑ cm	ltr.	Farbe / Colour	VE / unit
83780	6,0	4,0	0,04	—	24
83781	7,5	4,0	0,07	—	24
83782	8,0	4,5	0,08	—	24
83783	8,5	4,5	0,12	—	24
83798	6,0	4,0	0,04	—	24
83777	6,0	3,5	0,03	—	24



**Dipschälchen „GOURMET“**  
dip bowl  
cuenco para dip  
ramequin



	Ø cm	↑ cm	ltr.	Farbe / Colour	VE / unit
84018	7,0	6,0	0,05	—	20

## PARTY SPOONS



### Gourmetlöffel/-gabel, 6er Set

tapas spoon / fork, 6 pcs.  
cuchara / tenedor de tapas, set de 6  
cuillère / fourchette à tapas, set de 6

Verwendung als Löffel oder Gabel möglich

can be used as a spoon or fork

puede utilizarse como cuchara o tenedor

peut être utilisé comme une cuillère ou une fourchette



	→ cm	pcs.
00699	10	6



### Gourmetlöffel „CLASSIC“

party spoon  
cuchara gourmet  
cuillère gourmet



	→ cm		
00693	12,0	gunmetal look	PVD coated stainless steel
00677	13,5	stainless steel look	
00691	12,0	gold look	PVD coated stainless steel
00692	12,0	copper look	PVD coated stainless steel



### Becher Set „SUPER CUP“, 8er Set

barrel mug set, 8 pcs.

vasos, set de 8

gobelets, set de 8

Set bestehend aus 8 Bechern + 8 Deckeln

set consists of 8 barrel mugs + 8 lids

set compuesto por 8 vasos + 8 tapas

set composé de 8 gobelets + 8 couvercles



**IDEAL  
FÜR  
„TAKE AWAY“**

	Ø cm	↑ cm	ltr.	pcs.
10506	8	10	0,25	8



mit Stapelnocke  
with stacking cam



rutschfester Deckel  
non-slip lid



### Snackspender

snack dispenser  
dispensador de snacks  
distributeur de snacks

Behälter aus Glas, Schraubdeckel aus Edelstahl, Öffnung oval 3,5 x 2,5 cm

glass container, stainless steel screw cap, opening oval 3,5 x 2,5 cm

recipiente de cristal, tapón de rosca de acero inoxidable, apertura ovalada 3,5 x 2,5 cm

réipient en verre, couvercle à visser en acier inox, ouverture ovale 3,5 x 2,5 cm



	Ø cm	↑ cm	ltr.	Farbe / Colour
40516	8,5	15,5	0,35	Gold
40517	8,5	15,5	0,35	Schwarz



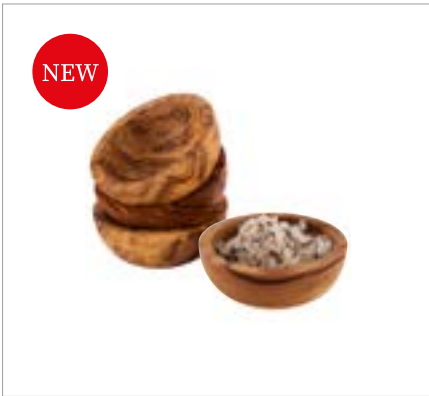

**Schale, 4er Set „OLIVE“**

bowl, 4 pcs.  
cuenco, set de 4  
bol, set de 4



aus geöltem Olivenholz, naturbedingte Abweichung in Form, Maserung und Größe  
oiled olive wood, natural deviation in shape, grain and size  
de madera de olivo aceitada, diferencias naturales posibles en forma, grano y tamaño  
en bois d'olivier huilé, éventuelles différences naturelles de forme, de grain et de taille

	Ø cm	↑ cm	ltr.	pcs.
01024	6	2	0,03	4



**Schale, 2er Set „OLIVE“**

bowl, 2 pcs.  
cuenco, set de 4  
bol, set de 4



aus geöltem Olivenholz, naturbedingte Abweichung in Form, Maserung und Größe  
oiled olive wood, natural deviation in shape, grain and size  
de madera de olivo aceitada, diferencias naturales posibles en forma, grano y tamaño  
en bois d'olivier huilé, éventuelles différences naturelles de forme, de grain et de taille

	cm	↑ cm	ltr.	pcs.
01025	12,5 x 8	2,5	0,05	2



**Schale „OLIVE“**

bowl  
cuenco  
bol



aus geöltem Olivenholz, naturbedingte Abweichung in Form, Maserung und Größe  
oiled olive wood, natural deviation in shape, grain and size  
de madera de olivo aceitada, diferencias naturales posibles en forma, grano y tamaño  
en bois d'olivier huilé, éventuelles différences naturelles de forme, de grain et de taille

	Ø cm	↑ cm	ltr.
01010	10,0	4,0	0,15
01011	12,5	4,5	0,25
01012	15,0	6,0	0,50



3 Größen ineinander  
3 sizes in each other



**Schale „OLIVE“**

bowl  
cuenco  
bol



aus geöltem Olivenholz, naturbedingte Abweichung in Form, Maserung und Größe  
oiled olive wood, natural deviation in shape, grain and size  
de madera de olivo aceitada, diferencias naturales posibles en forma, grano y tamaño  
en bois d'olivier huilé, éventuelles différences naturelles de forme, de grain et de taille

	cm	↑ cm	ltr.
00843	12,0 x 7,5	2,5	0,05
00844	16,5 x 9,5	2,5	0,10



00907 0,20 ltr.

00908 0,30 ltr.

01023 0,40 ltr.

Schale „OLIVE“

bowl  
cuenco  
bol



aus geöltem Olivenholz  
oiled olive wood  
de madera de olivo aceitada  
en bois d'olivier huilé

	cm	↑ cm	ltr.
00907	13 x 8	6,5	0,2
00908	16 x 9	7,0	0,3
01023	25 x 8,5	7,5	0,4



01013 0,05 ltr.

01014 0,15 ltr.

01015 0,60 ltr.

Schale „OLIVE“

bowl  
cuenco  
bol



aus geöltem Olivenholz, naturbedingte Abweichung in Form, Maserung und Größe  
oiled olive wood, natural deviation in shape, grain and size  
de madera de olivo aceitada, diferencias naturales posibles en forma, grano y tamaño  
en bois d'olivier huilé, éventuelles différences naturelles de forme, de grain et de taille

	cm	↑ cm	ltr.
01013	7,5 x 7,5	2,5	0,05
01014	17,5 x 8,5	2,5	0,15
01015	26,5 x 11,5	5,0	0,60



01022

01021

Servierbrett „OLIVE“

servicing board  
tabla de servir  
planche de service



aus geöltem Olivenholz, naturbedingte Abweichung in Form, Maserung und Größe  
oiled olive wood, natural deviation in shape, grain and size  
de madera de olivo aceitada, diferencias naturales posibles en forma, grano y tamaño  
en bois d'olivier huilé, éventuelles différences naturelles de forme, de grain et de taille

	cm	↑ cm
01022	39,5 x 21	2,5
01021	35,5 x 18,5	2,0



mit Saftrille  
with juice groove



00905

00906

Servierbrett „OLIVE“

servicing board  
tabla de servir  
planche de service



aus geöltem Olivenholz, naturbedingte Abweichung in Form, Maserung und Größe  
oiled olive wood, natural deviation in shape, grain and size  
de madera de olivo aceitada, diferencias naturales posibles en forma, grano y tamaño  
en bois d'olivier huilé, éventuelles différences naturelles de forme, de grain et de taille

	cm	↑ cm
00905	25,5 x 16,5	1,5
00906	35,0 x 20,5	1,5

**Servierbrett „OLIVE“**

serving board  
tabla de servir  
planche de service



aus geöltem Olivenholz, mit 19 mm Aufhäng Bohrung, naturbedingte Abweichung in Form, Maserung und Größe

oiled olive wood, natural deviation in shape, grain and size  
de madera de olivo aceitada, diferencias naturales posibles en forma, grano y tamaño

en bois d'olivier huilé, éventuelles différences naturelles de forme, de grain et de taille

	cm	↑ cm	Griff / handle cm
00870	25,0 x 17,0	1,5	-
00871	30,0 x 20,5	2,0	-
00875	19,0 x 12,5	1,5	6
00876	25,0 x 16,0	1,5	8
00877	31,0 x 20,0	1,5	9
00873	40,0 x 15,0	1,5	11
00874	44,0 x 20,0	2,0	12

**SNACKBOX „OLIVE“**

snackbox  
caja tentempié  
casse-croûte



aus geöltem Olivenholz

oiled olive wood  
de madera de olivo aceitada  
en bois d'olivier huilé

	cm	↑ cm
01016	22 x 15	6
01017	25 x 18	6

**Tablett**

tray  
bandeja  
plateau



aus Bambus, geeignet zum Servieren und Transportieren

made of bamboo, suitable for serving and transport  
de bambú, para servir y transportar  
en bambou, pour servir et transporter

	cm	↑ cm	GN
00845	32,5 x 26,5	3	1/2
00846	32,5 x 17,6	3	1/3



Präsentationsmöglichkeit  
presentation example



**Servierbrett „SHARING“**

servicing board  
tabla de servir  
planche de service



**Servierbrett aus geöltem Akazienholz**  
servicing board made of oiled acacia wood  
tabla de servir de madera de acacia aceitada  
planche en bois d'acacia huilé

	cm	↑ cm	Griff / handle cm
00887	51,5 x 18	1,5	8,5



2 tlg.  
2 pcs.

mit Absatz Ø 5 cm  
with hole Ø 5 cm

**Servierbrett**

servicing board  
tabla de servir  
planche de service



**2-teilig: 1 Holzbrett aus Akazienholz + 1 Naturschieferplatte**  
2 pcs.: 1 wood board made of acacia wood + 1 natural slate tray  
set de 2: 1 tabla de madera de acacia + 1 bandeja de pizarra natural  
set de 2: 1 planche en bois d'acacia + 1 plat ardoise naturelle

	cm	↑ cm
00814	28 x 17,5	2



2 tlg.  
2 pcs.

**Servierbrett**

servicing board  
tabla de servir  
planche de service



**2-teilig: 1 Holzbrett aus Akazienholz + 1 Naturschieferplatte**  
2 pcs.: 1 wood board made of acacia wood + 1 natural slate tray  
set de 2: 1 tabla de madera de acacia + 1 bandeja de pizarra natural  
set de 2: 1 planche en bois d'acacia + 1 plat ardoise naturelle

	cm	↑ cm	Griff / handle cm
00810	26 x 18	2	8
00811	33 x 20	2	8
00812	40 x 15	2	5
00813	43 x 12	2	12

Präsentationsmöglichkeit  
presentation example



mit Hängeloch Ø 2 cm / with a handle-hole Ø 2 cm



**Servierbrett „AKAZIE-SCHIEFER“**

servicing board  
tabla de servir  
planche de service



**raffiniertes, rustikales Servierbrett aus Akazienholz, ausgestattet mit einem Naturschieferstreifen zur Kennzeichnung**  
wood with slate, markable  
madera con pizarra, se puede marcar  
bois avec ardoise, on peut mettre une inscription

	cm	↑ cm	Griff / handle cm
00867	30,5 x 13	1,5	10
00868	36,5 x 15	1,5	12
00869	42,0 x 18	1,5	14



NEW

**Servierbrett**

serving board  
tabla de servir  
planche de service

aus geöltem Akazienholz / made of oiled acacia wood / de madera de acacia aceitada / en bois d'acacia huilé



	cm	↑ cm
00793	25 x 17	1,5



00898

40635

00899

**Servierbrett**

serving board  
tabla de servir  
planche de service

aus geöltem Akazienholz / made of oiled acacia wood / de madera de acacia aceitada / en bois d'acacia huilé



	cm	↑ cm
00897	30 x 15	2
00898	30 x 18	2
00899	35 x 25	2



NEW

40685

**Servierbrett**

serving board  
tabla de servir  
planche de service

aus geöltem Akazienholz / made of oiled acacia wood / de madera de acacia aceitada / en bois d'acacia huilé



	cm	↑ cm
00792	37 x 8	2



NEW

00791

00790

**Servierschale**

serving bowl  
cuenca de servir  
bol de service

aus geöltem Akazienholz / made of oiled acacia wood / de madera de acacia aceitada / en bois d'acacia huilé



	cm	↑ cm
00790	16,5 x 9	2
00791	23,5 x 13	2



**Servierbeispiel - Lieferung ohne Gläser**  
delivery without glasses

82359

82359

82359

00864

40685

40685

40685

00864

**Servierbrett „NARROW I“**

serving board  
tabla de servir  
planche de service

Akazienholz, mit 3 Vertiefungen Ø 4 cm / acacia wood, with 3 notches Ø 4 cm  
madera de acacia, con 3 ranuras Ø 4 cm / bois d'acacia, avec 3 encoches Ø 4 cm



	cm	↑ cm
00864	22 x 8	1,5

passende Schälchen / fitting bowls / cuencos adecuados / bols appropriés

	Ø cm	↑ cm	litr.	
82359	5	3,5	0,035	glass / 12 pcs
82350	6	5,5	0,08	glass / 12 pcs
40685	6	3,0	0,05	stainless steel



**Servierbrett „NARROW II“**

serving board  
tabla de servir  
planche de service

**Akazienholz, mit 3 Vertiefungen Ø 6 cm**

acacia wood, with 3 notches Ø 6 cm  
madera de acacia, con 3 ranuras Ø 6 cm  
bois d'acacia, avec 3 encoches Ø 6 cm



	cm	↑ cm
00878	31 x 11	2

**passende Schälchen / suitable bowls /  
cuencos adecuados / bols appropriés**



	Ø cm	↑ cm	ltr.	
40686	8	4,5	0,17	stainless steel
82316	7	8	0,22	glass / 12 pcs.
85080	8	7,5	0,05	melamine / 3 pcs.
85081	8	7,5	0,05	melamine / 3 pcs.



**Holzbox „TABLE“**

woodbox  
caja madera  
base bois

**Akazienholz, 3 Fächer (6,5 x 6,5 cm)**

acacia wood, 3 compartments (6,5 x 6,5 cm)  
madera de acacia, 3 compartimentos (6,5 x 6,5 cm)  
bois d'acacia, 3 compartiments (6,5 x 6,5 cm)



	cm	↑ cm	inner size cm
11727	23,5 x 8,5	4,5	6,5 x 6,5 je Fach / each compartment

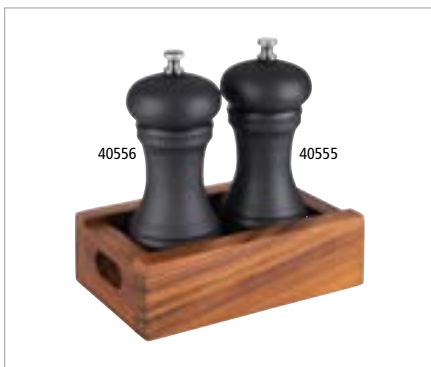

**Holzbox „TABLE“**

woodbox  
caja madera  
base bois

**Akazienholz, natur**

acacia wood, nature  
madera de acacia, natural  
bois d'acacia, naturel



	cm	↑ cm	inner size cm
11726	15 x 9,5	5	12 x 6,5



**Serviertablett**

serving tray  
bandeja para servir  
plateau de service

**aus geöltem Eichenholz, mit 2 Griffmulden**

made of oiled oak wood, with 2 recessed handles  
de madera de roble aceitada, con 2 asas empotradas  
en bois de chêne huilé, avec 2 poignées encastrées



	cm	↑ cm
00761	45 x 35	6

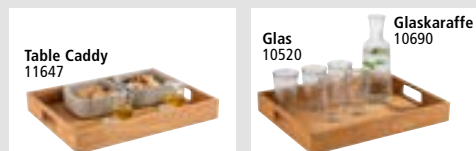

**Präsentationsmöglichkeit**  
presentation example

NEW

## SIMPLY WOOD



Eiche, das widerstandsfähigste europäische Holz, ist seit jeher Ausdruck von Qualität, Kraft und Energie.

Eichen werden uralt und riesengroß, sind unvergleichlich stark und standfest.

Oak, the most resistant European wood, has always been an expression of quality, strength and energy.

Oaks grow to be ancient and huge, are incomparably strong and stable.

El roble, la madera europea más resistente, siempre ha sido expresión de calidad, fuerza y energía. Los robles llegan a ser antiguos y gigantes, son incomparablemente fuertes y estables.

Le chêne, le bois européen le plus résistant, est depuis toujours l'expression de la qualité, de la force et de l'énergie.

Les chênes deviennent très vieux et gigantesques, ils sont incomparablement forts et stables.

NEW



00750



00751



00752

## Servierbrett „SIMPLY WOOD“

serving board  
tabla de servir  
planche de service



Eichenholz geölt, mit Aufhängeloch Ø 1,5 cm, mit Lederband

oak wood oiled, with handle hole Ø 1,5 cm, with leather strap

madera de roble aceitada, con agujero para colgar Ø 1,5 cm, con correa de cuero

bois de chêne huilé, avec trou de suspension Ø 1,5 cm, avec ruban en cuir

	cm	↑ cm	→ Griff / handle
00750	20 x 20	2	8
00751	27 x 17	2	8
00752	32 x 22	2	8



mit Lederband  
with leather strap

NEW



## Tablett / Sushiboard „SIMPLY WOOD“

tray / sushiboard  
bandeja para sushi  
plateau sushi

aus geöltem Eichenholz

made of oiled oak wood

de madera de roble aceitada

en bois de chêne huilé



	cm	↑ cm
00753	35 x 17	2



**GN 1/3 Servierbrett „SIMPLY WOOD“**

GN 1/3 serving board  
GN 1/3 tabla de servir  
GN 1/3 planche de service



**Eichenholz geölt, mit Vertiefung Ø 4 cm, mit Safrinne**  
oak wood oiled, with notch Ø 4 cm, with juice groove  
madera de roble aceitada, con ranura Ø 4 cm, con ranura para líquidos  
bois de chêne huilé, avec encoche Ø 4 cm, avec rigole

	cm	↑ cm	GN
00754	32,5 x 17,6	2	1/3



**Servierbrett**

serving board  
tabla de servir  
planche de service



**Eichenholz, geölt, 2 Vertiefungen Ø 4,5 cm, 1 Vertiefung Ø 3 cm, mit 2 Griffmulden**  
oak wood oiled, 2 notches Ø 4,5 cm, 1 notch Ø 3 cm, with 2 recessed handles  
madera de roble aceitada, 2 ranuras Ø 4,5 cm, 1 ranura Ø 3 cm, con 2 asas empotradas  
bois de chêne huilé, 2 encoches Ø 4,5 cm, 1 encoche Ø 3 cm, avec 2 poignées encastées

	cm	↑ cm
00835	15 x 9	1,5

passende Gläser / fitting glasses / tarros de vidrio adecuados / verrines appropriées

	Ø cm	↑ cm	ltr.	pcs
82350	5,5	6	0,075	12



**Servierbrett „PIZZA“**

serving board  
tabla de servir  
planche de service



**Eichenholz geölt, mit Safrinne, mit 2 Griffmulden**  
oak wood oiled, with juice groove, with 2 recessed handles  
madera de roble aceitada, con ranura para líquidos, con 2 asas empotradas  
bois de chêne huilé, avec rigole, avec 2 poignées encastées

	Ø cm	↑ cm
00755	24	2
00756	29	2
00757	34	2



mit 2 Griffmulden an der Unterseite  
with 2 recessed handles on the bottom



**Schaufel**

scoop  
pala  
pelle



**aus geöltem Eichenholz, ideal für Gewürze, Körner etc.**  
made of oiled oak wood, ideal for spices, grains etc.  
de madera de roble aceitada, ideal para especias, granos etc.  
en bois de chêne huilé, idéal pour les épices, céréales, etc.

	cm	↑ cm
01026	25,5 x 6	4,5



**Servierbrett „OAK“**

servicing board  
tabla de servir  
planche de service

aus geöltem Eichenholz, Safrille, Ø 9,5 cm Aussparung

made of oiled oak, with juice groove, with hole Ø 9.5 cm

de madera de roble aceitada, con ranura para líquidos, con agujero Ø 9,5 cm

en bois chêne huilé, avec rigole, avec trou Ø 9,5 cm



	cm	↑ cm
00808	37 x 25	2



mit Safrille  
with juice groove

**Naturschieferplatte**

natural slate tray  
bandeja pizarra natural  
plat ardoise naturelle

mit Safrille, Ø 9,5 cm Aussparung

with juice groove, with hole Ø 9.5 cm

con ranura para líquidos, con agujero Ø 9,5 cm

avec rigole, avec trou Ø 9,5 cm



	cm	* mm
00947	33 x 24	6 - 9

**Naturschieferplatte**

natural slate tray  
bandeja pizarra natural  
plat ardoise naturelle

mit Absatz Ø 6 cm

with hole Ø 6 cm

con agujero Ø 6 cm

avec trou Ø 6 cm



	cm	* mm
00986	25 x 12	6 - 9

**Naturschieferplatte**

natural slate tray  
bandeja pizarra natural  
plat ardoise naturelle

mit 3 Absätzen, Ø 6 cm

with 3 holes, Ø 6 cm

con 3 agujeros, Ø 6 cm

avec 3 trous, Ø 6 cm



	cm	* mm
00987	28 x 10	6 - 9

**Naturschieferplatte „STARTER“**

natural slate tray  
bandeja de pizarra natural  
plat ardoise naturelle carré



	cm	* mm
00937	20 x 10	6 - 9

## SERVING BOARDS | NATURAL SLATE



Weck-Glas 82316

### Naturschieferplatte / Untersetzer

natural slate tray  
bandeja de pizarra natural  
plateau ardoise naturelle

mit 2 Absätzen Ø 6 cm / with 2 holes Ø 6 cm / con 2 agujeros Ø 6 cm / avec 2 trous Ø 6 cm



	cm	✱ mm
00971	15 x 8	6 - 9

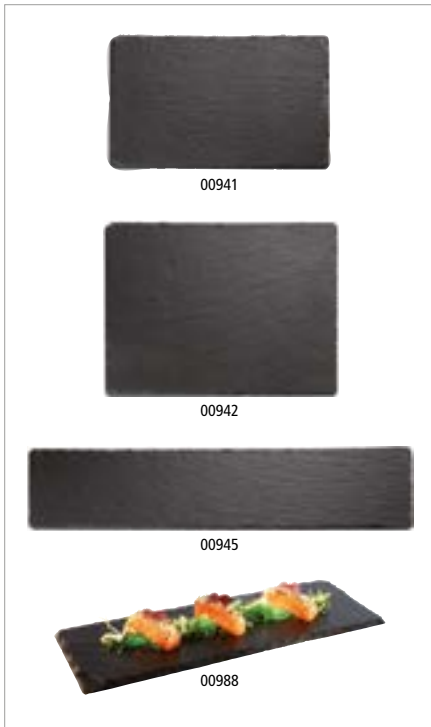

00941

00942

00945

00988

### Naturschieferplatte

natural slate  
bandeja de pizarra natural  
plateau ardoise naturelle



	cm	✱ mm
00941	24,0 x 15,0	6 - 9
00942	26,5 x 20,5	6 - 9
00945	47,0 x 10,0	6 - 9
00988	30,0 x 12,0	6 - 9

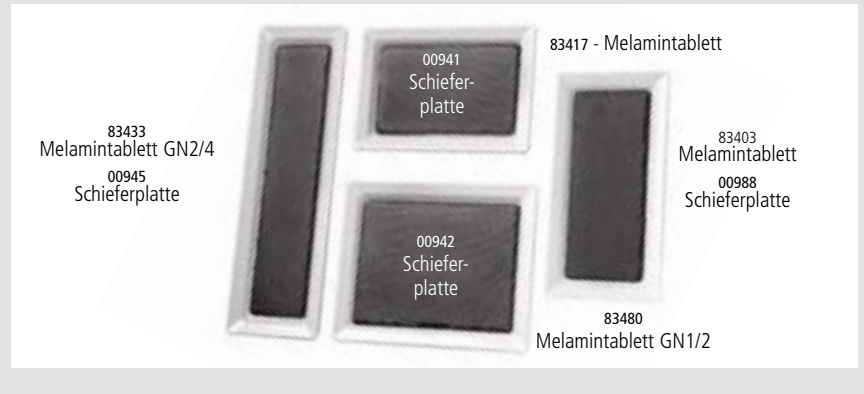

### Naturschieferplatte

natural slate tray  
bandeja de pizarra natural  
plat ardoise naturelle



	cm	✱ mm
00996	45 x 30	6 - 9



00994

### Naturschieferplatte

natural slate tray  
bandeja de pizarra natural  
plat ardoise naturelle



	cm	✱ mm
00994	25 x 25	6 - 9
00995	30 x 30	6 - 9



### Naturschieferplatte, 2-teilig

natural slate tray, 2 pcs. set  
bandeja de pizarra natural, set de 2  
plateau ardoise naturelle, set de 2

mit Glashaube

with glass cover

con tapa de cristal

avec cloche en verre

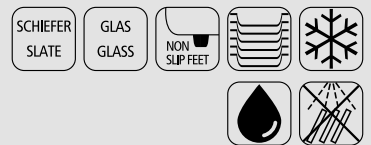

	Ø cm	↑ cm	✱ mm
00984	10,5	8	6 - 9



**Tablett „VINTAGE“**

tray  
bandeja  
plateau

**Antik-Edelstahl-Look**

stainless steel antique look  
acero estilo antiguo  
acier style antique



	cm	↑ cm	
30130	26,0 x 13,5	1,5	rectangular
30131	34,0 x 18,0	1,5	rectangular
30134	32,0 x 21,5	2,0	rectangular
30132	38,0 x 26,5	1,5	rectangular
30133	25,5 x 16,0	3,0	angular
30140	20 x 14,5	1,0	oval
30141	26,5 x 19,5	1,0	oval
30142	29,0 x 22,0	1,0	oval

passende Schälchen / fitting bowls / cuencos adecuados / bols apropiés



	Ø cm	↑ cm	ltr.
40655	7,5	5,5	0,17
40656	7,5	10	0,35



**Tablett „TREND“**

baking sheet  
bandeja  
plateau

**ein Backblech wird zum Servierblech**

a baking sheet which becomes a serving tray  
una bandeja de hornear que se convierte en una bandeja de servir  
un moule qui devient un plateau de service



	cm	↑ cm
13380	32 x 21,5	2



**Wachspapier „SNACKHOLDER“**

greaseproof paper squares  
papel alimenticio  
papier alimentaire



	cm	pcs.	Motiv:
40670	42 x 25	500	Zeitung

# MILLS



## Pfeffermühle

pepper mill  
molinillo de pimienta  
moulin à poivre



aus Buchenholz, Keramikmahlwerk, Mahlgrad stufenlos einstellbar

made of beech wood, ceramic grinder, infinitely adjustable grinding degree

madera de haya, molinillo de cerámica, el grado de molino se puede ajustar de modo continuo

bois de hêtre, moulin en céramique, la finesse de mouture se peut réglée de façon continue

	Ø cm	↑ cm	Farbe / Colour
40570	5,5	15,5	
40571	5,5	15,5	
40572	6,0	23,0	
40573	6,0	23,0	



Keramikmahlwerk  
ceramic grinder

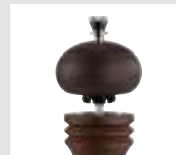

einfach zu Öffnen  
easy opening



einfach zu Befüllen  
easy to refill



## Salzmühle

salt mill  
molinillo de sal  
moulin à sel



aus Buchenholz, Keramikmahlwerk, Mahlgrad stufenlos einstellbar

made of beech wood, ceramic grinder, infinitely adjustable grinding degree

madera de haya, molinillo de cerámica, el grado de molino se puede ajustar de modo continuo

bois de hêtre, moulin en céramique, la finesse de mouture se peut réglée de façon continue

	Ø cm	↑ cm	Farbe / Colour
40574	5,5	15,5	
40575	5,5	15,5	
40576	6,0	23,0	
40577	6,0	23,0	



Keramikmahlwerk  
ceramic grinder

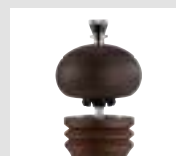

einfach zu Öffnen  
easy opening





P



40535

40548

**Pfeffermühle „PROFESSIONAL VINTAGE“**pepper mill  
molinillo de pimienta  
moulin à poivre

**Deutsches Buchenholz, Mahlwerk aus Carbonstahl, Mahlgrad stufenlos einstellbar**  
 german beechwood, mill in carbon steel, the grinding degree can be adjusted infinitely  
 madera de haya alemana, molinillo de acero al carbono, el grado de molino se puede ajustar de modo continuo  
 bois de hêtre d'Allemagne, moulin en acier de carbone, la finesse de mouture se peut réglée de façon continue

	Ø cm	↑ cm	Farbe / Colour
40535	5,5	15	
40537	6,0	23	
40546	5,5	15	
40548	6,0	23	

S



40536

40547

**Salzmühle „PROFESSIONAL VINTAGE“**salt mill  
molinillo de sal  
moulin à sel

**deutsches Buchenholz, Mahlwerk aus Edelstahl, Mahlgrad stufenlos einstellbar**  
 german beechwood, mill in stainless steel, the grinding degree can be adjusted infinitely  
 madera de haya alemana, molinillo de acero inoxidable, el grado de molino se puede ajustar de modo continuo  
 bois de hêtre d'Allemagne, moulin en acier inox, la finesse de mouture se peut réglée de façon continue

	Ø cm	↑ cm	Farbe / Colour
40536	5,5	15	
40547	5,5	15	

P

**Pfeffermühle „GUNMETAL“**pepper mill  
molinillo de pimienta  
moulin à poivre

**Mahlwerk aus Carbonstahl, Mahlgrad stufenlos einstellbar**  
 mill in carbon steel, the grinding degree can be adjusted infinitely  
 molinillo de acero al carbono, el grado de molino se puede ajustar de modo continuo  
 moulin en acier de carbone, la finesse de mouture se peut réglée de façon continue

	Ø cm	↑ cm
40555	6	15,5

S

**Salzmühle „GUNMETAL“**salt mill  
molinillo de sal  
moulin à sel

**Mahlwerk aus Edelstahl, Mahlgrad stufenlos einstellbar**  
 mill in stainless steel, the grinding degree can be adjusted infinitely  
 molinillo de acero inoxidable, el grado de molino se puede ajustar de modo continuo  
 moulin en acier inox, la finesse de mouture se peut réglée de façon continue

	Ø cm	↑ cm
40556	6	15,5

SALT- / PEPPER MILLS



**Pfeffermühle „ELEMENT“**

pepper mill  
molinillo de pimienta  
moulin à poivre



**Mahlwerk aus Carbonstahl, Mahlgrad stufenlos einstellbar**

mill in carbon steel, the grinding degree can be adjusted infinitely  
molinillo de acero al carbono, el grado de molino se puede ajustar de modo continuo  
moulin en acier de carbone, la finesse de mouture se peut régler de façon continue

	Ø cm	↑ cm
40538	6	18



**Salzmühle „ELEMENT“**

salt mill  
molinillo de sal  
moulin à sel



**Mahlwerk aus Edelstahl, Mahlgrad stufenlos einstellbar**

mill in stainless steel, the grinding degree can be adjusted infinitely  
molinillo de acero inoxidable, el grado de molino se puede ajustar de modo continuo  
moulin en acier inox, la finesse de mouture se peut régler de façon continue

	Ø cm	↑ cm
40539	6	18



**Pfeffermühle „ELEMENT“**

pepper mill  
molinillo de pimienta  
moulin à poivre



**Mahlwerk aus Carbonstahl, Mahlgrad stufenlos einstellbar**

mill in carbon steel, the grinding degree can be adjusted infinitely  
molinillo de acero al carbono, el grado de molino se puede ajustar de modo continuo  
moulin en acier de carbone, la finesse de mouture se peut réglée de façon continue

	Ø cm	↑ cm
40557	7,5	15,5



**Salzmühle „ELEMENT“**

salt mill  
molinillo de sal  
moulin à sel



**Mahlwerk aus Edelstahl, Mahlgrad stufenlos einstellbar**

mill in stainless steel, the grinding degree can be adjusted infinitely  
molinillo de acero inoxidable, el grado de molino se puede ajustar de modo continuo  
moulin en acier inox, la finesse de mouture se peut régler de façon continue

	Ø cm	↑ cm
40558	7,5	15,5



**Pfeffermühle „PROFESSIONAL“**

pepper mill  
molinillo de pimienta  
moulin à poivre



**Mahlgrad stufenlos einstellbar**

the grinding degree can be adjusted infinitely  
el grado de molino se puede ajustar de modo continuo  
la finesse de mouture se peut réglée de façon continue

	Ø cm	↑ cm
40540	5,5	15



S

**Salzmühle „PROFESSIONAL“**

salt mill  
molinillo de sal  
moulin à sel

**Mahlgrad stufenlos einstellbar**

the grinding degree can be adjusted infinitely  
el grado de molino se puede ajustar de modo continuo  
la finesse de mouture se peut réglée de façon continue

	Ø cm	↑ cm
40541	5,5	15



P

**Pfeffermühle „DIAMOND“**

pepper mill  
molinillo de pimienta  
moulin à poivre

**Mahlwerk aus Carbonstahl, Mahlgrad stufenlos einstellbar**

mill in carbon steel, the grinding degree can be adjusted infinitely  
molinillo de acero al carbono, el grado de molino se puede ajustar de modo continuo  
moulin en acier de carbone, la finesse de mouture se peut réglée de façon continue

	Ø cm	↑ cm
40553	6	18



S

**Salzmühle „DIAMOND“**

salt mill  
molinillo de sal  
moulin à sel

**Mahlwerk aus Edelstahl, Mahlgrad stufenlos einstellbar**

mill in stainless steel, the grinding degree can be adjusted infinitely  
molinillo de acero inoxidable, el grado de molino se puede ajustar de modo continuo  
moulin en acier inox, la finesse de mouture se peut réglée de façon continue

	Ø cm	↑ cm
40554	6	18



P

**Pfeffermühle „FRIDA“**

pepper mill  
molinillo de pimienta  
moulin à poivre

**Mahlwerk aus Carbonstahl, Mahlgrad stufenlos einstellbar**

mill in carbon steel, the grinding degree can be adjusted infinitely  
molinillo de acero al carbono, el grado de molino se puede ajustar de modo continuo  
moulin en acier de carbone, la finesse de mouture se peut réglée de façon continue

	Ø cm	↑ cm
40549	6	15,5



S

**Salzmühle „FRIDA“**

salt mill  
molinillo de sal  
moulin à sel

**Mahlwerk aus Edelstahl, Mahlgrad stufenlos einstellbar**

mill in stainless steel, the grinding degree can be adjusted infinitely  
molinillo de acero inoxidable, el grado de molino se puede ajustar de modo continuo  
moulin en acier inox, la finesse de mouture se peut réglée de façon continue

	Ø cm	↑ cm
40550	6	15,5

## SALT- / PEPPER MILLS



P

### Pfeffermühle „COPPER“

pepper mill  
molinillo de pimienta  
moulin à poivre



Mahlwerk aus Carbonstahl, Mahlgrad stufenlos einstellbar

mill in carbon steel, the grinding degree can be adjusted infinitely  
molinillo de acero al carbono, el grado de molino se puede ajustar de modo continuo  
moulin en acier de carbone, la finesse de mouture se peut réglée de façon continue

	Ø cm	↑ cm
40551	6	15



S

### Salzmühle „COPPER“

salt mill  
molinillo de sal  
moulin à sel



Mahlwerk aus Edelstahl, Mahlgrad stufenlos einstellbar

mill in stainless steel, the grinding degree can be adjusted infinitely  
molinillo de acero inoxidable, el grado de molino se puede ajustar de modo continuo  
moulin en acier inox, la finesse de mouture se peut réglée de façon continue

	Ø cm	↑ cm
40552	6	15



NEW

3-tlg.  
3 pcs.

P

S

40417

40418

### Pfeffer- und Salz-Menage „URBAN“

salt- and pepper-menage  
salero-pimentero  
ménage sel et poivre



3-teiliges Set, bestehend aus:

- Gestell, Metall, schwarz, mit Kartenhalterung
- Pfeffermühle aus Akazienholz mit Mahlwerk aus Carbonstahl
- Salzmühle aus Akazienholz mit Mahlwerk aus Edelstahl

3 pcs., consisting of:

- stand, metal, black, with card holder
- pepper mill made of acacia wood with grinding mechanism made of carbon steel
- salt mill made of acacia wood with grinding mechanism made of stainless steel

set de 3, compuesto por:

- soporte, metal, negro, con porta menu
- molinillo de pimienta de madera de acacia con mecanismo de molienda de acero al carbono
- molinillo de sal de madera de acacia con mecanismo de molienda de acero inoxidable

set de 3, composé de :

- support, métal, noir, avec porte-cartes
- moulin à poivre en bois d'acacia avec broyeur en acier au carbone
- moulin à sel en bois d'acacia avec broyeur en acier inox

	cm	↑ cm
40416	12 x 8,5	24

Pfeffermühle / pepper mill / molinillo de pimienta / moulin à poivre

	Ø cm	↑ cm
40417	5	17

Salzmühle / salt mill / molinillo de sal / moulin à sel

	Ø cm	↑ cm
40418	5	17



### Naturschieferplatte / Untersetzer

natural slate tray  
bandeja de pizarra natural  
plateau ardoise naturelle



mit 2 Absätzen Ø 6 cm / with 2 holes Ø 6 cm / con 2 agujeros Ø 6 cm / avec 2 trous Ø 6 cm

	cm	* mm
00971	15 x 8	6 - 9





**2 in 1 Salz- und Pfeffermühle**

2 in 1 salt and pepper mill  
2 in 1 molinillo de sal y pimienta  
2 in 1 moulin à sel et poivre



Keramik Mahlwerk / ceramic mechanism / molinillo de céramica / broyeur en céramique

	Ø cm	↑ cm
40545	7,5	18,5



Mahlgrad einstellbar  
grinder setting

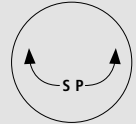

**2 in 1 Salz- und Pfeffermühle**

2 in 1 salt and pepper mill  
2 in 1 molinillo de sal y pimienta  
2 in 1 moulin à sel et poivre



Keramik Mahlwerk / ceramic mechanism / molinillo de céramica / broyeur en céramique

	cm	↑ cm
40544	6 x 4,5	9,5



Mahlgrad einstellbar  
grinder setting

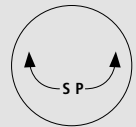

**Salz- und Pfefferstreuer, 2er Set**

salt - and pepper shaker, 2 pcs.  
piezas de sal y pimienta, set de 2  
sel et poivre, set de 2



	Ø cm	↑ cm	pcs.	
40501	5	6,5	2	geriffelte Ausführung / fluted version versión ondulada / forme ondulée
40507	6	10,0	2	

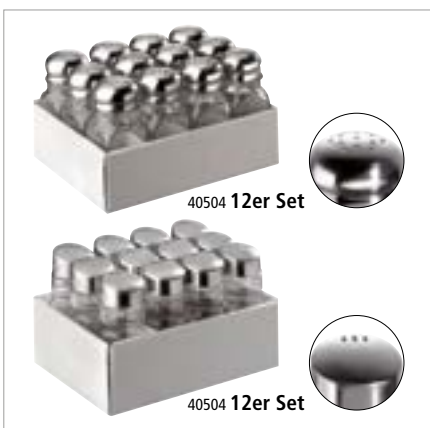

**Allzweckstreuer, 12er Set**

shaker, 12 pcs.  
dosificador, set de 12  
salières/poivrières, set de 12



	cm	↑ cm	pcs.	
40504	4 x 4	10	12	13 Löcher / 13 holes 13 agujeros / 13 trous
40505	3	9	12	3 Löcher / 3 holes 3 agujeros / 3 trous



**Ministreuer, 4er Set**

mini shaker, 4 pcs.  
dosificador mini, set de 4  
mini-salières, set de 4



	Ø cm	↑ cm	pcs.
40503	3,5	4	4

## SALT- / PEPPER MILLS



### Multistreuer

multi-functional shaker  
multi dosificador  
saupoudreuse



Lochgröße einstellbar / adjustable hole size / tamaño del agujero ajustable / taille du trou réglable

	Ø cm	↑ cm	ltr.
00773	6	8	0,05
00774	7	12	0,20
00781	6,5	12	0,20
00782	6,5	12	0,20
00783	6,5	12	0,20



### Netzstreuer

mesh top shaker  
polvoreador, tapa con malla fina  
pot à épices, couvercle toile fine



	Ø cm	↑ cm	ltr.
00776	5,5	7,5	0,15



### Streuer fein

small hole shaker  
polvoreador, tapa con agujeros pequeños  
pot à épices, couvercle à petits trous



	Ø cm	↑ cm	ltr.
00777	5,5	7,5	0,15



### Streuer grob

large hole shaker  
polvoreador, tapa con agujeros grandes  
pot à épices, couvercle à grands trous



	Ø cm	↑ cm	ltr.
00778	5,5	7,5	0,15



### Käse- oder Gewürzstreuer

spice shaker  
bote especiero  
saupoudreuse à épices



	Ø cm	↑ cm	ltr.
00775	5,5	7,5	0,15



### Salzstreuer

salt shaker  
salero  
salière



Pommes-Frites Streuer mit Schraubkappe / for french fries, cover to screw / para patatas fritas, tapa de rosca / pour les frites, couvercle à visser

	Ø cm	↑ cm	
00779	8	17	Aluminium / aluminium
00772	8	17	Edelstahl / stainless steel

# MENAGES



## Menage „WOOD“

menage  
menage  
ménage



**matt poliert, Glasbehälter mit Edelstahldeckel und Deckelverschluss**

matt polished, glass with stainless steel cover  
pulido mate, cristal con tapa de acero inoxidable  
verre et inox poli mat, avec couvercle inox

	cm	↑ cm
40435	11,5 x 5,5	17



## Menage „WOOD“

menage  
menage  
ménage



**matt poliert, Glasbehälter mit Edelstahldeckel und Deckelverschluss**

matt polished, glass with stainless steel cover  
pulido mate, cristal con tapa de acero inoxidable  
verre et inox poli mat, avec couvercle inox

	cm	↑ cm
40436	16 x 7,5	24,5



## Menage „WOOD“

menage  
menage  
ménage



**matt poliert, möbelschonende Unterseite**

matt polished, glass with stainless steel cover  
pulido mate, con tapa de acero inoxidable  
verre et inox poli mat, avec couvercle inox

	cm	↑ cm
40437	15,5 x 12	24,5

**Salz- und Pfefferstreuer / salt - and pepper shaker / juego de sal y pimienta / set sel et poivre**

	Ø cm	↑ cm	
40438	4	9	6 Löcher - Ø 1,85 mm
40439	4	9	18 Löcher - Ø 1,35 mm

**Ersatzglas Essig / Öl / spare glass vinegar / oil / cristal de recambio con tapa „aceite & vinagre“**  
verre huile ou vinagre

	Ø cm	↑ cm	ltr.
40442	6	18,5	0,2



**Menage „ELEMENT“**

menage  
menage  
ménage



**Betonständer, Glasbehälter mit Edelstahldeckel, möbelschonende Unterseite**

stand made of concrete, glass with stainless steel cover, furniture-friendly underside  
soporte de hormigón, recipiente de vidrio con tapa de acero inoxidable, con base anti rayaduras

support en béton, récipient en verre avec couvercle en acier inox, revêtement antirayures

	cm	↑ cm
40410	10 x 6	17



**Menage „ELEMENT“**

menage  
menage  
ménage



**Betonständer, Glasbehälter mit Edelstahldeckel und tropffreiem Kunststoff-Ausgießer, möbelschonende Unterseite**

stand made of concrete, glass with stainless steel cover and non-drip nozzle-spout, furniture-friendly underside

soporte de hormigón, recipiente de vidrio con tapa de acero inoxidable y sistema antigoteo, base anti rayaduras

support en béton, récipient en verre avec couvercle en acier inox et verseur antigoutte, revêtement antirayures

	cm	↑ cm
40411	14 x 8	25



**Menage „ELEMENT“**

menage  
menage  
ménage



**Betonständer, Glasbehälter mit Edelstahldeckel und Drehverschluss, möbelschonende Unterseite**

stand made of concrete, glass with stainless steel cover and screw cap, furniture-friendly underside

soporte de hormigón, recipiente de vidrio con tapa de acero inoxidable y tapón de rosca, base anti rayaduras

support en béton, récipient en verre avec couvercle en acier inox et bouchon à vis, avec revêtement antirayures

	cm	↑ cm
40412	12,5 x 12,5	25



**Menage „ELEMENT“**

menage  
menage  
ménage

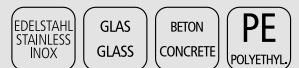

**Betonständer mit Kartenhalterung, Glasbehälter mit Edelstahldeckel und Drehverschluss, möbelschonende Unterseite**

stand made of concrete with card holder, glass with stainless steel cover and screw cap, furniture-friendly underside

soporte de hormigón con tarjetero, recipiente de vidrio con tapa de acero inoxidable y tapón de rosca, base anti rayaduras

support en béton avec porte-cartes, récipient en verre avec couvercle en acier inox et bouchon à vis, revêtement antirayures

	cm	↑ cm
40413	14 x 13,5	20



mit Kartenhalterung an der Rückseite  
with card holder at the back



**Menage „CLASSIC“**

menage  
menage  
ménage



**Glasbehälter mit Edelstahldeckel und Drehverschluss**

glass with stainless steel cover  
vidrio con tapa de acero inoxidable con rosca  
en verre avec couvercle inox à visser

	cm	↑ cm
40310	10,5 x 6,5	16



**Menage „CLASSIC“**

menage  
menage  
ménage



**Glasbehälter mit Edelstahldeckel und Drehverschluss**

glass with stainless steel cover  
vidrio con tapa de acero inoxidable con rosca  
en verre avec couvercle inox à visser

	Ø cm	↑ cm
40320	10,5	16



**Menage „CLASSIC“**

menage  
menage  
ménage



**Glasbehälter mit Edelstahldeckel und tropffreiem Kunststoff-Ausgießer**

with stainless steel cover and non-drip nozzle-spout  
vidrio con tapa inox y sistema antigoteo  
verre avec couvercle inox et verseur antigoutte

	cm	↑ cm	ltr.
40440	14,5 x 8,5	23	0,2
40450	17,5 x 10,5	23	

**Ersatzglas mit Deckel / spare glass with cover / vidrio con tapa / verre + couvercle**

	Ø cm	↑ cm	
40312	4	9	18 Löcher - Ø 1,35 mm
40311	4	9	6 Löcher - Ø 1,85 mm

**Ersatzglas mit Deckel „Essig & Öl“ / spare glass with cover „vinegar & oil“ / cristal de recambio con tapa „vinegar & oil“ / verre huile ou vinaige avec couvercle inox et verseur antigoutte**

	Ø cm	↑ cm	ltr.
40441	6	18,5	0,2

**Ersatzglas mit Deckel „Zahnstocher“ / spare glass with cover „toothpick“ / porta-palillos vidrio con tapa / verre à cure-dents + couvercle**

	Ø cm	↑ cm
40313	4	9



**Senftöpfchen, 2er Set**

mustard glass, 2 pcs. set  
piezas vasos mostaza, set de 2  
verres à moutarde, set de 2



**inklusive Löffel und Edelstahldeckel**

including spoons and covers  
incluye cucharas y tapas  
cuillères et couvercles inclus

	Ø cm	↑ cm	ltr.	pcs.
40415	5	6	0,07	2

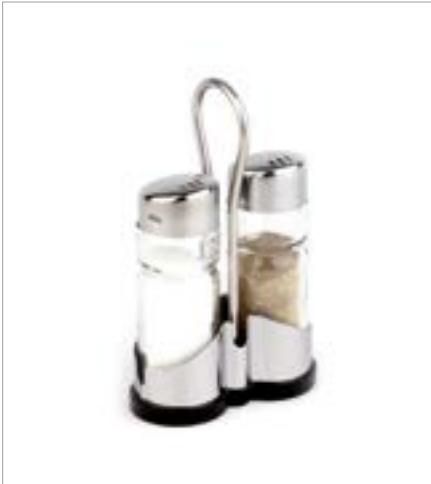

**Menage „ECONOMIC“**

menage  
menage  
ménage



**Glasbehälter mit Edelstahldeckel und Drehverschluss**

glass with stainless steel cover  
cristal con tapa inox a rosca  
en verre avec couvercle inox à visser

	cm	↑ cm
40455	8 x 4	13



**Menage „ECONOMIC“**

menage  
menage  
ménage



**Glasbehälter mit Edelstahldeckel und Drehverschluss**

glass with stainless steel cover  
cristal con tapa inox a rosca  
en verre avec couvercle inox à visser

	cm	↑ cm
40457	8 x 8	12

**Glas für Senf / glass for mustard / vaso de cristal para mostaza / pot verre seul pour la moutarde**

40464



40458

**Menage „ECONOMIC“**

menage  
menage  
ménage



**Glasbehälter mit Edelstahldeckel und tropffreiem Kunststoff-Ausgießer**

glasses with stainless steel cover and non-drip nozzle-spout  
cristales con tapa de acero inoxidable y sistema antigoteo  
en verre avec couvercle inox et insert plastique antigoutte

	cm	↑ cm
40458	11,5 x 5,5	22
40460	11,0 x 10,5	22

**Pfeffer- oder Salz-Glasstreuer / pepper- or salt-glass with cover salero o pimentero de cristal con tapa / salière ou poivrière seule en verre avec couvercle inox**

	Ø cm	↑ cm
40461	3	9

**Essig- oder Öl-Glasbehälter / oil- or vinegar-glass with cover / aceitera-vinagrera con tapa bouteille huile ou vinaigre seule en verre et couv. inox**

	Ø cm	↑ cm
40462	4,5	16

**Glas für Zahnstocher / glass for tooth picks / vaso de cristal para palillos de dientes porte-cure-dents env erre**

	Ø cm	↑ cm
40463	3	6

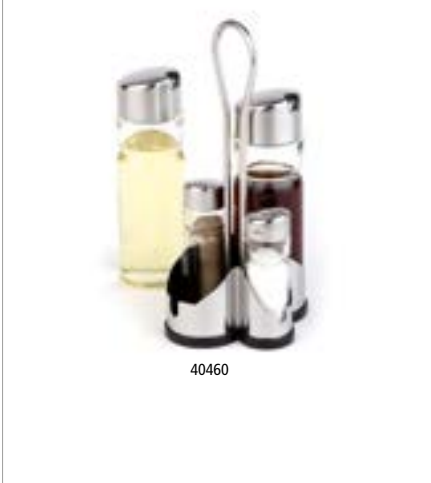

40460



40476



40478



40480

**Menage „PRO“**

menage  
menage  
ménage



**matt poliert, Glasbehälter mit Edelstahldeckel und tropffreiem Kunststoff-Ausgießer**

matt polished, glass with stainless steel cover and non-drip nozzle-spout

pulido mate, vidrio, sistema antigoteo

poli mat et verre, insert plastique antigoutte

	cm	↑ cm
40476	12,0 x 8,0	19
40478	12,5 x 11,0	19
40480	13,0 x 11,0	19

**Pfeffer- oder Salz-Glasstreuer / pepper- or salt-glass with cover / salero o pimentero de cristal con tapa / salière ou poivrière seule en verre avec couvercle inox**

	Ø cm	↑ cm
40461	3	9

**Essig- oder Öl-Glasbehälter / oil- or vinegar-glass with cover / aceitera-vinagrera con tapa bouteille huile ou vinaigre seule en verre et couv. inox**

	Ø cm	↑ cm
40462	4,5	16



40470



40472



40474

**Menage „PRO“**

menage  
menage  
ménage



**matt poliert, Glasbehälter mit Edelstahldeckel und Drehverschluss**

matt polished, glass with stainless steel cover

pulido mate, vidrio y tapas con rosca

poli mat et verre, couvercle à visser

	cm	↑ cm
40470	8,5 x 5,5	11,5
40472	9,0 x 8,5	11,5
40474	10,0 x 10,0	11,5



**Parmesan-Menage „CLASSIC“**

cheese dish  
quesera parmesano  
service à parmesan  
schwarz matt, inklusive Löffel  
black mat, with spoon  
negro mate, con cuchara  
noir mat, avec cuillère



	Ø cm	↑ cm	ltr.
40333	11,0	7,0	0,18

Ersatzbehälter / sparecontainer / bol de recambio / bol de rechange

	Ø cm	↑ cm	ltr.
40331	9,0	5,0	0,18



**Parmesan-Menage „CLASSIC“**

cheese dish  
quesera parmesano  
service à parmesan  
hochglanzpoliert, inklusive Löffel  
mirror polished, with spoon  
pulido brillante, con cuchara  
poli brillant, avec cuillère



	Ø cm	↑ cm	ltr.
40330	11,0	7,0	0,18

Ersatzbehälter / sparecontainer / bol de recambio / bol de rechange

	Ø cm	↑ cm	ltr.
40331	9,0	5,0	0,18



**Parmesan-Menage „PROFI“**

cheese dish  
quesera parmesano  
service à parmesan  
hochglanzpoliert, inklusive Löffel  
mirror polished, with spoon  
pulido brillante, con bol cristal y cuchara  
brillant, avec bol verre et cuillère



	Ø cm	↑ cm	ltr.
40424	9,0	6,5	0,18

Ersatzbehälter / spare container / bol de recambio / bol de rechange

	Ø cm	↑ cm	ltr.
40331	9,0	5,0	0,18



**Parmesan-Menage „PRO“**

cheese dish  
quesera parmesano  
service à parmesan  
matt poliert, inklusive Löffel  
matt polished, with spoon  
pulido mate, con bol cristal y cuchara  
poli mat, avec bol verre et cuillère



	Ø cm	↑ cm	ltr.
40482	10,5	13,0	0,18

Ersatzbehälter / sparecontainer / bol de recambio / bol de rechange

	Ø cm	↑ cm	ltr.
40331	9,0	5,0	0,18





**Parmesan-Menage „ECONOMIC“**

cheese dish  
quesera parmesano  
service à parmesan  
inklusive Kunststofföffel  
with spoon  
con cuchara  
avec cuillère



	Ø cm	↑ cm	ltr.
40453	10,0	7,5	0,23

**Ersatzbehälter / sparecontainer / bol de recambio / bol de rechange**

	Ø cm	↑ cm	ltr.
40454	9,0	5,5	0,23



**Essig- & Öl-Menage**

oil- and vinegar-menage  
aceitera-vinagrera  
ménage huile et vinaigre



**Glasbehälter mit Deckel und tropffreiem PE-Ausgießer**

glass with lid and non-drip nozzle-spout  
recipiente de cristal con tapa y sistema antigoteo  
pot en verre avec couvercle et système plastique antigoutte

	cm	↑ cm	ltr.
40445	10,5 x 5,5	24	0,12
40446	13,0 x 7,0	34	0,50



tropffreier Ausgießer  
non-drip spout



**Gewürzständer**

condiment stand  
soporte salsas y condimentos  
porte condiments et sauces



matt poliert  
matt polished  
pulido mate  
poli mat

	Ø cm	↑ cm
40300	18	20



**Menage**

menage  
menage  
ménage



**drehbares Gestell, Glasbehälter mit Edelstahldeckel und Drehverschluss**

rotating stand, glass with stainless steel cover  
soporte giratorio con piezas de vidrio y tapas inox  
tournant, avec pièces en verre et couvercle inox

	Ø cm	↑ cm
40485	16	20



**Ständer „URBAN“**

serving stand  
soporte 2 botellas  
support 2 bouteilles

**Metall schwarz, mit Kartenhalterung**

metal black, with card holder  
metal negro, con tarjetero  
métal noir, avec porte-cartes



	cm	↑ cm
40414	13 x 8,5	25

**Pfeffermühle / pepper mill / molinillo de pimienta / moulin à poivre**

	Ø cm	↑ cm
40555	6	15,5

**Salzmühle / salt mill / molinillo de sal / moulin à sel**

	Ø cm	↑ cm
40556	6	15,5



mit Kartenhalterung an der Rückseite  
with card holder at the back



**Spritzflasche inklusive Ausgießer**

squeeze bottle with nozzle  
botella exprimible con dosificador  
flacon pulvérisateur avec bec verseur

**ideal für Bitter-Liköre, Essig, Öl**

perfect for bitter liqueur, vinegar, oil  
perfecto para licores amargos, vinagre, aceite  
idéal pour liqueur amère, vinaigre, huile



	cm	↑ cm	litr.
93308	6 x 5	20	0,2

**Ersatzausgießer passend für Spritzflasche / nozzle suitable for squeeze bottle / dosificador apto para botella exprimible / bec verseur approprié pour flacon pulvérisateur**

	Ø cm	↑ cm
93309	2,5	5,5



**Essig- & Öl-Flasche „OLD FASHIONED“**

oil- and vinegar bottle  
botella de aceite y vinagre  
bouteille d'huile et vinaigre

**Glasflasche, Edelstahl - Ausgießer mit Deckel**

glass bottle, stainless steel spout with lid  
botella de vidrio, pico verteder de acero inoxidable con tapa  
bouteille en verre, bec verseur en acier inox avec couvercle



	Ø cm	↑ cm	litr.
40511	7	22	0,35



**Zuckerkuigel**

sugar pot  
azucarero  
sucrier

**hochglanzpoliert, mit Rolldeckel**

mirror polished, rolltop cover  
pulido brillante, tapa abatible  
poli brillant, couvercle abattant



	Ø cm	↑ cm
00033	13,5	15



**Zuckerspender**

sugar pourer  
dispensador de azúcar  
sucrier doseur

**matt poliert / matt polished / pulido mate / poli mat**



	Ø cm	↑ cm	ltr.
10316	5	15	0,17



**Zuckerdosierer**

sugar dispenser  
azucarero  
sucrier

**Schraubdeckel aus Edelstahl, mit Dosierrohr**

cover stainless steel, with dosing tube  
tapa inoxidable y tubo, con tubo dosificador  
couvercle inox et tube doseur



	Ø cm	↑ cm	ltr.
40509	6	14,5	0,2



**Zuckerdosierer**

sugar dispenser  
azucarero  
sucrier

**mit Schraubverschluss, Dosierrohr**

cover and dosing tube  
con tapa y tubo dosificador  
couvercle avec tube doseur



	Ø cm	↑ cm	ltr.
40508	6,5	14,5	0,20



**Zuckerdosierer**

sugar dispenser  
azucarero  
sucrier

**Schraubdeckel aus Edelstahl / cover stainless steel / tapa inoxidable / couvercle inox**

	Ø cm	↑ cm	ltr.
00766	8,5	15	0,3

**Ersatzglasbehälter / spare glas-container / contenedor de repuesto / récipient verre de rechange**

00768			
-------	--	--	--

## SUGAR DISPENSERS



### Zuckerdosierer

sugar dispenser  
azucarero  
sucrier

Schraubdeckel aus Edelstahl, mit Dosierrohr

cover stainless steel, with dosing tube  
tapa inoxidable y tubo dosificador  
couvercle inoxydable et tube doseur



	Ø cm	↑ cm	ltr.
40506	7,5	17,0	0,32



### Zuckerdosierer

sugar dispenser  
azucarero  
sucrier

Schraubdeckel aus Edelstahl, mit Dosierrohr

cover stainless steel, with dosing tube  
tapa inoxidable y tubo, con tubo dosificador  
couvercle inox et tube doseur



	Ø cm	↑ cm	ltr.
40486	8	15	0,25



### Zuckerdosierer

sugar dispenser  
azucarero  
sucrier

Schraubdeckel aus Edelstahl, mit Dosierrohr

cover stainless steel with dosing tube  
tapa inoxidable y tubo dosificador  
couvercle inox et tube doseur



	Ø cm	↑ cm	ltr.
40490	8,5	12	0,15
40494	8,0	15	0,25



### Zuckerdosierer

sugar dispenser  
azucarero  
sucrier

Schraubdeckel mit Klappe aus Edelstahl, mit Dosierklappe

cover stainless steel, with dosing flap  
tapa acero inoxidable, con tubo dosificador  
couvercle inox, avec couvercle doseur



	Ø cm	↑ cm	ltr.
40487	7,5	13,5	0,32



### Zuckerdosierer „OLD FASHIONED“

sugar dispenser  
azucarero  
sucrier

Schraubdeckel mit Klappe aus Edelstahl, mit Dosierklappe

cover stainless steel, with dosing flap  
tapa acero inoxidable, con tubo dosificador  
couvercle inox, avec couvercle doseur



	Ø cm	↑ cm	ltr.
40510	7,5	14	0,35



300 ml

**Allzweckgießer**

pourer  
bote vertedor universal  
pot verseur universel

für Honig, Kaffeesahne, etc., Schraubdeckel aus Edelstahl

for honey, cream, etc., cover stainless steel

para miel, crema, etc., tapa inoxidable

pour le miel, le lait, la crème, etc., couvercle inox



	Ø cm	↑ cm	ltr.
00765	8,5	13,5	0,3

Ersatzglasbehälter / spare glas-container / contenedor de repuesto / récipient verre de rechange

00768



250 ml

**Allzweckgießer**

pourer  
dosificador  
doseur

Schraubdeckel aus Edelstahl und Kunststoff, mit Dosierklappe

cover stainless steel and plastic, with dosing flap

acero inoxidable y tapa plástico, con tubo dosificador

couvercle en inox et plastique, avec couvercle doseure



	Ø cm	↑ cm	ltr.
40488	8	12,5	0,25

**Milchkännchen, 4er Set**

milk/cream jugs, 4 pcs.  
pack de 4 jarritas para leche o crema  
pack de 4 crémiers

hochglanzpoliert, für Kaffeesahne, mit Griff, Inhalt à 25 ml

mirror polished, for coffee-cream, with handle, capacity à 25 ml

pulido brillante, para crema de café, con asa, capacidad 25 ml

poli brillant, avec anse, 25 ml



	Ø cm	↑ cm	pcs.	ltr.
10321	3,5	3,5	4	0,025

**Mini-Milchkanne „SNACKHOLDER“ 4er Set**

mini milk can, 4 pcs.  
lechera en formato mini, set de 4  
pot à lait mini, set de 4



	Ø cm	↑ cm	ltr.	pcs.
40640	4,5	5	0,08	4



NEW

5-tlg.  
5 pcs.**Milch- und Zucker-Set**

bowl  
cuenco  
bol

5-teilig: Tablett, Milchkanne, Zuckerdose mit Deckel, Löffel, Akazienholz, Edelstahl PTFE beschichtet, schwarz

5 pcs.: tray, milk jug, sugar bowl with lid, spoon, acacia wood, stainless inox PTFE coated, black

set de 5: bandeja, jarra de leche, azucarero con tapa, cuchara, madera de acacia, acero inoxidable revestimiento PTFE, negro

set de 5: plateau, pichet à lait, sucrier avec couvercle, cuillère, bois d'acacia, acier inox revêtement PTFE, noir



	cm	↑ cm
00634	19 x 10	10,5



**Butterservierer**  
butter dish  
mantequillera  
beurrer



	cm	↑ cm	ltr.
15925	Ø 9	9	0,07
15926	9 x 9	9	0,075



**Butterservierer**  
butter dish  
mantequillera  
beurrer



hochglanzpoliert  
mirror polished  
acabado brillante  
poli brillant

	Ø cm	↑ cm	ltr.
15921	9	7	0,06



**Schale „ENAMELWARE“**  
bowl  
cuenco  
bol



	cm	↑ cm	ltr.
40667	16 x 12,0	3,5	0,20
40668	18 x 13,5	4,0	0,35



**Kühlschrank-Butterdose**  
refrigerator butter dish  
mantequillera para nevera  
boîte à beurre pour le frigo



	cm	↑ cm
00063	16 x 9,5	5,5



**Eierbecher**  
egg holder  
huevera  
coquetier



	Ø cm	↑ cm
00032	8,5	2



### Fondue und Feuerzangenbowle-Set „TWO IN ONE“

fondue and fire punch bowl set  
set para fondue o ponche caliente  
service à fondue et à punch



13-teiliges Set aus Edelstahl bestehend aus:

1 Topf, 1 Rechaud, 1 Spritzschutz, 1 Untersetzer, 1 Schöpfkelle, 1 Feuerzange,  
1 Pastenbrenner, 6 Fonduegabeln

13-piece stainless steel set consisting of:

1 pot, 1 rechaud, 1 splash guard, 1 coaster, 1 ladle, 1 fire tongs,  
1 paste burner, 6 fondue forks

set de 13 piezas de acero inoxidable compuesto por:

1 olla, 1 rechaud, 1 protector contra salpicaduras, 1 trébede, 1 cazo,  
1 pinza para el fuego, 1 quemador de pasta, 6 tenedores de fondue

set de 13 pièces en acier inox comprenant:

1 marmite, 1 rechaud, 1 pare-éclaboussures, 1 dessous de plat, 1 louche, 1 pince à feu,  
1 brûleur à pâte, 6 fourchettes à fondue

	Ø cm	↑ cm	ltr.
65060	22	23	2,2



### Kaviarkühler

caviar cooler  
enfriador de caviar  
rafraîchisseur de caviar



4-teilig: Glasschale Ø 10 cm / 4 pcs.: glass bowl Ø 10 cm / set de 4: bol Ø 10 cm  
set de 4: bol Ø 10 cm

	Ø cm	↑ cm
01699	18	12

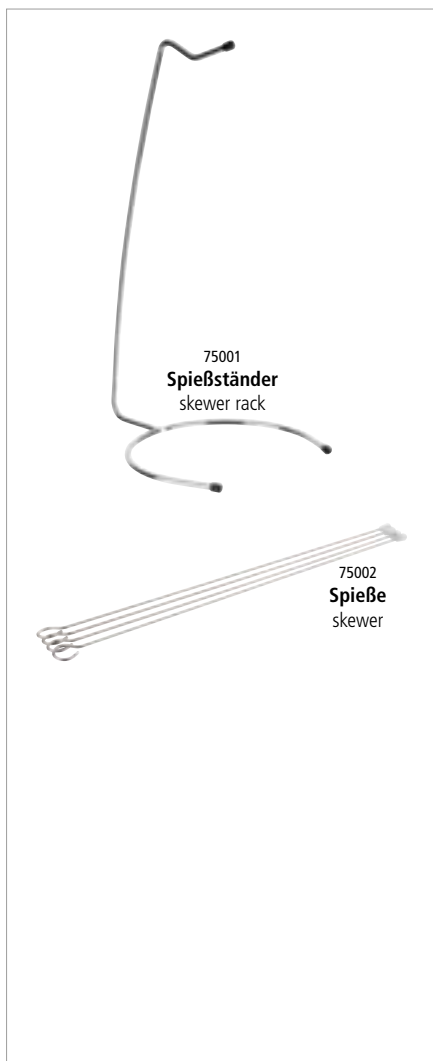

### Spießständer

espetada and kebab skewer rack  
soporte para brochetas  
support pour brochettes



zum Servieren von Fleischspießen bis 40 cm, Gestell aus 8 mm Edelstahl, ohne Spieße

to serve skewers up to 40 cm, wire stainless steel 8 mm, without skewer  
para servir brochetas de carne hasta 40 cm, grosor del alambre 8 mm, sin brochetas  
pour présenter les brochettes long. maxi 40 cm, fil 8 mm, sans brochettes

	Ø cm	↑ cm
75001	22,0	46

### Spieße, 4er Set

skewer, 4 pcs.  
brochetas, set de 4  
brochettes, set de 4



4er Set, offener Haken, Ende spitz, passend zu 75001

4 pcs., open hook, pointed end, suitable for 75001  
set de 4, gancho abierto, extremo puntiagudo, apto para 75001  
set de 4, crochet ouvert, extrémité pointue, convient pour 75001

	Ø cm	↑ cm	pcs.
75002	0,3	40	4



Präsentationsmöglichkeit  
presentation example

## TABLE CADDYS



### Table Caddy „ELEMENT“

table caddy  
caddy de mesa  
caddy de table



**Beton, möbelschonende Unterseite, 1 Fach: 14,5 x 14 cm**

concrete, furniture-friendly underside, 1 compartment: 14,5 x 14 cm

hormigón, base anti rayaduras, 1 compartimento: 14,5 x 14 cm

béton, revêtement antirayures, 1 compartiment: 14,5 x 14 cm

	cm	↑ cm
11647	16,5 x 16	6,5



### Table Caddy „ELEMENT“

table caddy  
caddy de mesa  
caddy de table



**Beton, möbelschonende Unterseite, 1 Fach: 14,5 x 14 cm, 2 Löcher je 6,5 cm**

concrete, furniture-friendly underside, 1 compartment: 14,5 x 14 cm, 2 holes each 6.5 cm

hormigón, base anti rayaduras, 1 compartimento: 14,5 x 14 cm, 2 agujeros cada uno 6,5 cm

béton, revêtement antirayures, 1 compartiment: 14,5 x 14 cm, 2 trous de 6,5 cm chacun

	cm	↑ cm	inner size cm
11648	23,5 x 16	6,5	14,5 x 14



### Table Caddy

table caddy  
caddy de mesa  
caddy de table



**Akazienholz, 2-Fächer: 21,5 x 8 cm**

acacia wood, 2 compartements: 21,5 x 8 cm

madera de acacia, 2 compartimentos: 21,5 x 8 cm

bois d'acacia, 2 compartiments : 21,5 x 8 cm

	cm	↑ cm
40405	25 x 15	18



### Table Caddy „VINTAGE“

table caddy  
caddy de mesa  
caddy de table



**Tannenzholz, 2 Fächer: 13,5 x 6 cm**

fir wood, 2 compartments: 13,5 x 6 cm

madera de abeto, 2 compartimentos: 13,5 x 6 cm

bois de sapin, 2 compartiments : 13,5 x 6 cm

	cm	↑ cm
40404	15,5 x 15,5	15



### Holzbox „WOODY“

woodbox  
caja madera  
base bois



**Akazienholz, 4-Fächer: 12,5 x 8 cm**

acacia wood, 4 compartements: 12,5 x 8 cm

madera de acacia, 4 compartimentos: 12,5 x 8 cm

bois d'acacia, 4 compartiments : 12,5 x 8 cm

	cm	↑ cm
11649	36 x 14	12,5





Servierbeispiel - Lieferung ohne Gläser  
delivery without glasses

**Holzbox „TABLE“**

woodbox  
caja madera  
base bois



**Akazienholz, 3 Fächer: 6,5 x 6,5 cm**

acacia wood, 3 compartments: 6,5 x 6,5 cm  
madera de acacia, 3 compartimentos: 6,5 x 6,5 cm  
bois d'acacia, 3 compartiments : 6,5 x 6,5 cm

	cm	↑ cm
11727	23,5 x 8,5	4,5



**Holzbox „TABLE“**

woodbox  
caja madera  
base bois



**Akazienholz, 1 Fach: 12 x 6,5 cm**

acacia wood, 1 compartment: 12 x 6,5 cm  
madera de acacia, 1 compartimento: 12 x 6,5 cm  
bois d'acacia, 1 compartiment: 12 x 6,5 cm

	cm	↑ cm
11726	15,0 x 9,5	5



**Table Caddy**

table caddy  
caddy de mesa  
caddy de table



**Akazienholz, 1 Fach: 21,5 x 8 cm**

acacia wood, 1 compartment: 21,5 x 8 cm  
madera de acacia, 1 compartimento: 21,5 x 8 cm  
bois d'acacia, 1 compartiment: 21,5 x 8 cm

	cm	↑ cm
11625	23 x 10	10



**Holzbox „WOODY“**

woodbox  
caja madera  
base bois



**Akazienholz, 1 Fach: 13 x 13 cm**

acacia wood, 1 compartment: 13 x 13 cm  
madera de acacia, 1 compartimento: 13 x 13 cm  
bois d'acacia, 1 compartiment : 13 x 13 cm

	cm	↑ cm
11650	15,0 x 15	5,5

**Akazienholz, 2 Fächer: 13,5 x 13 cm / 6,5 x 13 cm**

acacia wood, 2 compartments: 13,5 x 13 cm / 6,5 x 13 cm  
madera de acacia, 2 compartimentos: 13,5 x 13 cm / 6,5 x 13 cm  
bois d'acacia, 2 compartiments : 13,5 x 13 cm / 6,5 x 13 cm

	cm	↑ cm
11651	22,5 x 15	5,5

## CANDLE HOLDERS



### Kerzenleuchter

candle holder  
candelabro  
chandelier

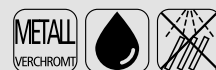

**extra schwerer Fuß, verchromt, möbelschonende Unterseite**

heavy foot, chrome plated, furniture-friendly underside

pie pesado, asa cromado, base anti rayaduras

piéd lourd, chromé, revêtement antirayures

	Ø cm	↑ cm	Farbe / Colour
04020	10	11	—
04021	10	16	—



### Windlichter „ELEMENT“, 2er Set

wind lights, 2 pcs.

portavelas antiviento, set de 2

porte-bougies anti-vent, set de 2

**Beton, Gläser klar, möbelschonende Unterseite**

concrete, glass clear, furniture-friendly underside

hormigón, vidrio transparente, base anti rayaduras

béton, verre transparente, revêtement antirayures



	Ø cm	↑ cm	pcs.
03038	6	8	2

**Ersatzglas / spare glass / vidrio de recambio solo / verre de rechange transparent, seul**

	Ø cm	↑ cm
03098	6	5



### Windlicht „ELEMENT“

wind light

porta vela

porte-bougie

**Beton, Glas klar, möbelschonende Unterseite**

concrete, glass clear, furniture-friendly underside

hormigón, vidrio transparente, base anti rayaduras

béton, verre transparente, revêtement antirayures



	Ø cm	↑ cm
03039	7,5	13

**Ersatzglas / spare glass / vidrio de recambio solo / verre de rechange transparent, seul**

	Ø cm	↑ cm
03099	7,5	9



**Vase mit Glaseinsatz „ELEMENT“**

flower vase with glass insert  
florero con tubo de cristal  
vase soliflor avec verre



**Beton, Glas klar, möbelschonende Unterseite, inkl. 2 Ersatzgläsern**

concrete, clear glass, furniture-friendly underside, incl. 2 spare glasses  
hormigón, cristal incoloro, base anti rayaduras, incl. 2 tubos de repuesto  
béton, verre transparente revêtement antirayures y compris 2 verres de rechange

	cm	↑ cm	ml
04010	10 x 4,5	12,5	25



**Ersatzglas / spare glass / tubo de recambio / verre de rechange**

	Ø cm	↑ cm	ml
04011	2,5	11	25



**Vase**

flower vase  
florero  
vase soliflor



**Edelstahl-Look, Zinkdruckguss, vernickelt, lackiert, anlaufgeschützt, schwere Ausführung**

stainless steel look, heavy zink alloy, nickel plated, laquered  
aspecto acero, acabado satinado, alta calidad  
aspect inox, fini poli mat, bonne qualité

	Ø cm	↑ cm	kg
04015	4,0	16,5	0,17



**Vase**

flower vase  
florero  
vase soliflor



**Edelstahl-Look, Zinkdruckguss, vernickelt, lackiert, anlaufgeschützt, schwere Ausführung**

stainless steel look, heavy zink alloy, nickel plated, laquered  
aspecto acero, acabado satinado, alta calidad  
aspect inox, fini poli mat, bonne qualité

	Ø cm	↑ cm	kg
04017	6,5	18	0,36



# PLACEMATS

Die umgelegten und angenähten Kanten machen diese Tischsets besonders robust. Geliefert in einer 6er Einheit.

The folded and sewn edges make these table sets particularly robust. Delivered in a packing unit of 6 pieces.

Los bordes doblados y cosidos des los mantelitos los hacen especialmente resistentes. Se entregan en una unidad de embalaje de 6 piezas.

Les bords repliés et cousus rendent ces sets de table en particulierement robustes. Livré dans un emballage de 6 pièces.



## Warenträger - Tischsets

display for placemats  
expositor para mantelinas de mesa  
présentoir pour sets de table

12 Einschubfächer, komplett auf Rollen, 2 Feststellrollen, Lieferung demontiert

12 shelves, on rolls, 2 rolls to fix, delivery unassembled

12 niveles, 4 ruedas, desmontado (montaje fácil)

12 niveaux, 4 roues, livré démonté

	cm	↑ cm
00401	39,5 x 45	165

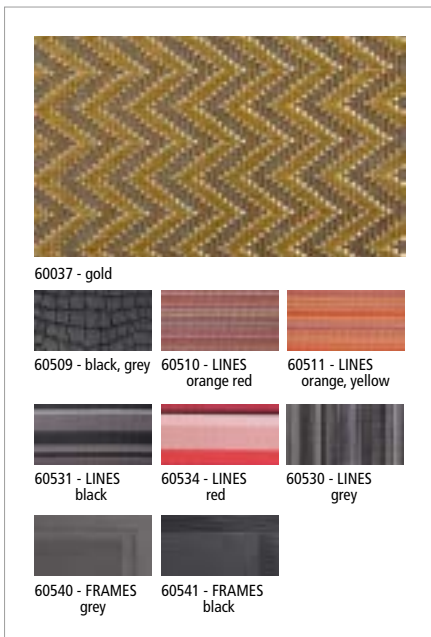

## Tischset Feinband

placemat fine band  
mantelín cinta fina  
set de table, tressage fin



	cm		VE / unit
60037	45 x 33	gold / gold	6
60509	45 x 33	Mosaik schwarz, grau / black, grey	6
60510	45 x 33	LINES orange, rot / LINES orange red	6
60511	45 x 33	LINES orange, gelb / LINES orange yellow	6
60531	45 x 33	LINES schwarz / LINES black	6
60534	45 x 33	LINES rot / LINES red	6
60530	45 x 33	STRIPES grau / STRIPES grey	6
60540	45 x 33	FRAMES grau / FRAMES grey	6
60541	45 x 33	FRAMES schwarz / FRAMES black	6

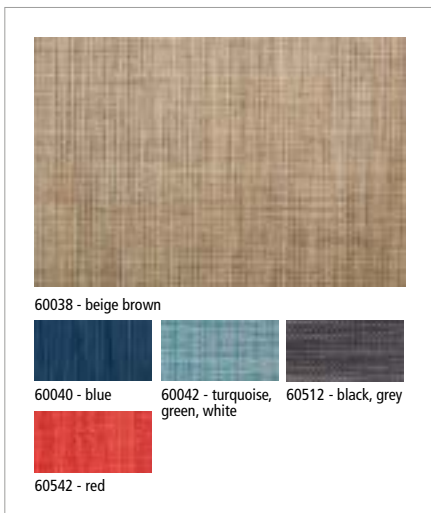

## Tischset Feinband

placemat fine band  
mantelín cinta fina  
set de table, tressage fin



	cm		VE / unit
60038	45 x 33	beige braun / beige brown	6
60040	45 x 33	blau / blue	6
60042	45 x 33	türkis, grün, weiß / turquoise, green, white	6
60512	45 x 33	schwarz, grau / black, grey	6
60542	45 x 33	rot / red	6



60502 - grey, beige



60503 - beige    60505 - brown    60508 - blue

### Tischset „TAO“

placemat fine band  
mantelín cinta fina  
set de table, tressage fin



	cm		VE / unit
60502	45 x 33	grau, beige / grey, beige	6
60503	45 x 33	beige / beige	6
60505	45 x 33	braun / brown	6
60508	45 x 33	hellblau, dunkelblau / light blue, dark blue	6

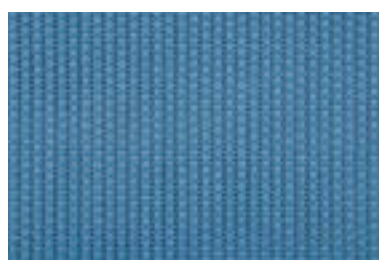

60002 - light blue



60018 - candyred    60012 - black    60014 - beige



60015 - silbergrey    60016 - green    60019 - beige brown



60522 - light orange    60520 - black/white    60521 - apple green



60523 - purple    60524 - platinum    60041 - light blue, white



60525 - white    60526 - gold    60527 - silver



60528 - green

### Tischset Schmalband

placemat smallband  
mantelín cinta estrecha  
set de table tressage étroit



	cm		VE / unit
60002	45 x 33	hellblau / light blue	6
60018	45 x 33	candyrot / candyred	6
60012	45 x 33	schwarz / black	6
60014	45 x 33	beige / beige	6
60015	45 x 33	silbergrau / silbergrey	6
60016	45 x 33	grün / green	6
60019	45 x 33	beige braun / beige brown	6
60522	45 x 33	hellorange / light orange	6
60520	45 x 33	schwarz weiß / black white	6
60521	45 x 33	apfelgrün / apple green	6
60523	45 x 33	violett / purple	6
60524	45 x 33	platin / platinum	6
60041	45 x 33	hellblau, weiß / light blue, white	6
60525	45 x 33	weiß / white	6
60526	45 x 33	gold / gold	6
60527	45 x 33	silber / silver	6
60528	45 x 33	grün / green	6



60551



60551 - silbergrau / silbergrey    60552 - beige / braun    60554 - platin

### Servietten- und Bestecktaschen, 6er Set

cutlery bag, 6 pcs. set  
bolsa cubiertos, set de 6  
pochette couverts, set de 6



	cm		pcs.
60551	24 x 9	silbergrau / silbergrey	6
60552	24 x 9	beige braun / beige brown	6
60554	24 x 9	platin / platinum	6

## PLACEMATS



### Tischset placemat mantelín set de table



#### Kunstleder, mit Naht rundherum

imitation leather, with seam all around  
imitación de cuero, con costura alrededor  
similicuir, avec couture tout autour

	cm		VE / unit
60044	45 x 32,5	grau / grey	6
60045	45 x 32,5	braun / brown	6
60046	45 x 32,5	schwarz / black	6



### Tischset placemat mantelín set de table



#### rutschhemmende Unterseite

slip resistant underside  
parte inferior antideslizante  
dessous antidérapant

	cm		VE / unit
60543	45 x 30	silber / silver	6



### Tischset „PURE“ placemat mantelín set de table



#### rutschhemmende Unterseite

slip resistant underside  
parte inferior antideslizante  
dessous antidérapant

	cm		VE / unit
60544	45 x 30	sand / sand	6
60545	45 x 30	bronze/schwarz / bronze/black	6
60546	45 x 30	bron/schwarz / silver/black	6



### Tischset „CROCO“ placemat mantelín set de table



#### rutschhemmende Unterseite

slip resistant underside  
parte inferior antideslizante  
dessous antidérapant

	cm		VE / unit
60535	45 x 30	gold / gold	6
60536	45 x 30	kupfer / copper	6
60537	45 x 30	braun / brown	6

# ENAMELWARE



## Teller, flach „ENAMELWARE“

plate, flat  
plato, plano  
assiette, plat



	Ø cm	↑ cm	Farbe / Colour
40664	20	2	
40665	24	2	
40666	26	2	



## Teller, tief „ENAMELWARE“

plate, deep  
plato, profunda  
assiette, profonde



	Ø cm	↑ cm	ltr.	Farbe / Colour
40661	18	3,5	0,35	
40662	22	3,5	0,60	
40663	24	3,5	0,85	



## Schale „ENAMELWARE“

bowl  
cuenco  
bol



	cm	↑ cm	ltr.	Farbe / Colour
40667	16 x 12,0	3,5	0,20	
40668	18 x 13,5	4,0	0,35	



## Schale „ENAMELWARE“

bowl  
cuenco  
bol



	cm	↑ cm	ltr.	Farbe / Colour
40669	28 x 23	4,5	1,9	

## ENAMELWARE



### Henkelbecher „ENAMELWARE“

beaker  
vaso coctelero  
bol mélangeur



	Ø cm	↑ cm	ltr.	Farbe / Colour
40636	7	5	0,10	White / Blue
40632	9	8	0,35	White / Blue
40637	10	9	0,50	White / Blue



### Henkelbecher „ENAMELWARE“

beaker  
vaso coctelero  
bol mélangeur



	Ø cm	↑ cm	ltr.	Farbe / Colour
40633	9	8	0,35	Red / Black



### Henkelbecher „ENAMELWARE“

beaker  
vaso coctelero  
bol mélangeur



	Ø cm	↑ cm	ltr.	Farbe / Colour
40634	9	8	0,35	Dark Green / Black



### Henkelbecher „ENAMELWARE“

beaker  
vaso coctelero  
bol mélangeur



	Ø cm	↑ cm	ltr.	Farbe / Colour
40635	9	8	0,35	Blue / Black



### Schale „ENAMELWARE“

bowl  
cuenco  
bol



	Ø cm	↑ cm	ltr.	Farbe / Colour
40645	7,0	4,5	0,08	White / Blue
40646	8,0	3,5	0,08	White / Blue
40638	13,0	6,0	0,50	White / Blue
40647	16,5	4,5	0,45	White / Blue



# Original WECK



## Weck-Flaschen, 6er Set

Weck-bottles, 6 pcs.  
Weck-botellas, set de 6  
Weck-bouteilles, set de 6



**6 Flaschen + 6 Deckel, ideal zum Servieren von Saft, Smoothie, Dressing und Saucen**  
6 bottles + 6 covers, ideal for serving juice, smoothie, dressing and sauces  
6 botellas + 6 tapas, ideal para servir zumo, licuado, aliño y salsas  
6 bouteilles + 6 couvercles, idéal pour servir de jus, smoothie, vinaigrette et sauces

	Ø cm	↑ cm	ltr.	pcs
82307	6	14,5	0,25	6



## Weck-Flaschen, 6er Set

Weck-bottles, 6 pcs.  
Weck-botellas, set de 6  
Weck-bouteilles, set de 6



**6 Flaschen + 6 Deckel, ideal zum Servieren von Saft, Smoothie, Dressing und Saucen**  
6 bottles + 6 covers, ideal for serving juice, smoothie, dressing and sauces  
6 botellas + 6 tapas, ideal para servir zumo, licuado, aliño y salsas  
6 bouteilles + 6 couvercles, idéal pour servir de jus, smoothie, vinaigrette et sauces

	Ø cm	↑ cm	ltr.	pcs
82308	6	19	0,5	6



## Weck-Flaschen, 6er Set

Weck-bottles, 6 pcs.  
Weck-botellas, set de 6  
Weck-bouteilles, set de 6



**6 Flaschen + 6 Deckel, ideal zum Servieren von Saft, Smoothie, Dressing und Saucen**  
6 bottles + 6 covers, ideal for serving juice, smoothie, dressing and sauces  
6 botellas + 6 tapas, ideal para servir zumo, licuado, aliño y salsas  
6 bouteilles + 6 couvercles, idéal pour servir de jus, smoothie, vinaigrette et sauces

	Ø cm	↑ cm	ltr.	pcs
82309	6	25,5	1,0	6

# GLASSES



## Weck-Gläser mit Deckel, 2er Set

Weck-glasses with lid, 2 pcs.  
Weck tarros de vidrio con tapa, set de 2  
Weck verrines avec couvercle, set de 2



### 2 Gläser + 2 Edelstahldeckel

2 glasses + 2 stainless steel lids  
2 tarros + 2 tapas de acero inoxidable  
2 verrines + 2 couvercles en acier inox

	Ø cm	↑ cm	ltr.	pcs
82239	11	7,5	0,37	2
82240	11	11	0,58	2



## Edelstahldeckel für Weck-Gläser

stainless steel lid for Weck-glasses  
tapas de acero inoxidable por Weck tarros  
couvercles en acier inox pour Weck verrines



	Ø cm	↑ cm	
82360	10,5	2	82239, 82240, 82346, 82347



## Weck-Gläser mit Deckel, 2er Set

Weck-glasses with lid, 2 pcs.  
Weck tarros de vidrio con tapa, set de 2  
Weck verrines avec couvercle, set de 2



### 2 Gläser + 2 klappbare Edelstahldeckel

2 glasses + 2 foldable stainless steel lids  
2 tarros + 2 tapas plegables de acero inoxidable  
2 verrines + 2 couvercles pliables en acier inox

	Ø cm	↑ cm	ltr.	pcs
82241	11	7,5	0,37	2
82242	11	11	0,58	2



## klappbarer Edelstahldeckel für Weck-Gläser

foldable stainless steel lid for Weck-glasses  
tapa plegable de acero inoxidable por Weck tarros  
couvercle pliable en acier inox pour Weck verrines



	Ø cm	↑ cm	
82361	10,5	4,5	82241, 82242, 82346, 82347

**Weck-Gläser mit Deckel, 2er Set**

Weck-glasses with lid, 2 pcs.

Weck tarros de vidrio con tapa, set de 2

Weck verrines avec couvercle, set de 2

**2 Gläser + 2 Deckel aus Buchenholz**

2 glasses + 2 beech wood lids

2 tarros + 2 tapas de madera de haya

2 verrines + 2 couvercles en bois de hêtre



	Ø cm	↑ cm	ltr.	pcs
82243	11	7,5	0,37	2
82244	11	11	0,58	2

**Holzdeckel für Weck-Gläser**

wooden lid for Weck-glasses

tapas de madera por Weck tarros

couvercles en bois pour Weck verrines



	Ø cm	↑ cm	fits to
82362	11	2	82243, 82244, 82346, 82347

**Weck-Gläser mit Deckel, 12er Set**

Weck-glasses with lid, 12 pcs.

Weck tarros de vidrio con tapa, set de 12

Weck verrines avec couvercle, set de 12

**12 Gläser + 12 Deckel aus Buchenholz**

12 glasses + 12 beech wood lids

12 tarros + 12 tapas de madera de haya

12 verrines + 12 couvercles en bois de hêtre



	Ø cm	↑ cm	ltr.	pcs.
82245	6	7	0,14	12

**Weck-Gläser mit Deckel, 12er Set**

Weck-glasses with lid, 12 pcs.

Weck tarros de vidrio con tapa, set de 12

Weck verrines avec couvercle, set de 12

**12 Gläser + 12 Deckel aus Buchenholz**

12 glasses + 12 beech wood lids

12 tarros + 12 tapas de madera de haya

12 verrines + 12 couvercles en bois de hêtre



	Ø cm	↑ cm	ltr.	pcs.
82246	7	8	0,22	12

**Holzdeckel für Weck-Gläser, 12er Set**

wooden lid for Weck-glasses, 12 pcs.

tapas de madera para Weck tarros, set de 12

couvercles en bois pour Weck verrines, set de 12



	Ø cm	↑ cm	fits to	pcs.
82363	7	1,5	82245, 82246, 82307, 82308, 82309, 82310, 82312, 82314, 82316, 82370, 82371	12

## GLASSES



### Weck-Gläser mit Deckel, 12er Set

Weck-glasses with lid, 12 pcs.  
Weck tarros de vidrio con tapa, set de 12  
Weck verrines avec couvercle, set de 12

**12 Gläser + 12 Deckel**

12 glasses + 12 covers

12 vasos + 12 tapas

12 verrines + 12 couvercles



	Ø cm	↑ cm	ltr.	pcs
82310	6	5,5	0,08	12
82312	6	7,0	0,14	12
82314	6	8,0	0,16	12
82345	9	6	0,20	12

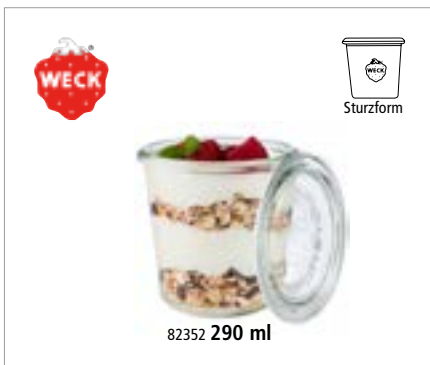

### Weck-Gläser mit Deckel, 6er Set

Weck-glasses with lid, 6 pcs.  
Weck tarros de vidrio con tapa, set de 6  
Weck verrines avec couvercle, set de 6

**6 Gläser + 6 Deckel**

6 glasses + 6 covers

6 tarros + 6 tapas

6 verrines + 6 couvercles



	Ø cm	↑ cm	ltr.	pcs
82352	9	9	0,29	6



### Weck-Gläser mit Deckel, 3er Set

Weck-glasses with lid, 3 pcs.  
Weck tarros de vidrio con tapa, set de 3  
Weck verrines avec couvercle, set de 3

**3 Gläser + 3 Deckel**

3 glasses + 3 covers

3 vasos + 3 tapas

3 verrines + 3 couvercles



	Ø cm	↑ cm	ltr.	pcs
82346	11	7,5	0,37	3



### Weck-Gläser mit Deckel, 2er Set

Weck-glasses with lid, 2 pcs.  
Weck tarros de vidrio con tapa, set de 2  
Weck verrines avec couvercle, set de 2

**2 Gläser + 2 Deckel**

2 glasses + 2 covers

2 vasos + 2 tapas

2 verrines + 2 couvercles



	Ø cm	↑ cm	ltr.	pcs
82347	11	11	0,58	2



82350 75 ml

82316 220 ml

**Weck-Gläser mit Deckel, 12er Set**

Weck-glasses with lid, 12 pcs.

Weck tarros de vidrio con tapa, set de 12

Weck verrines avec couvercle, set de 12

**12 Gläser + 12 Deckel**

12 glasses + 12 covers

12 vasos + 12 tapas

12 verrines + 12 couvercles



	Ø cm	↑ cm	ltr.	pcs
82350	5,5	6	0,075	12
82316	7	8,0	0,22	12



82354 580 ml

**Weck-Gläser mit Deckel, 6er Set**

Weck-glasses with lid, 6 pcs.

Weck tarros de vidrio con tapa, set de 6

Weck verrines avec couvercle, set de 6

**6 Gläser + 6 Deckel**

6 glasses + 6 covers

6 tarros + 6 tapas

6 verrines + 6 couvercles



	Ø cm	↑ cm	ltr.	pcs
82354	11	9	0,58	6



82359 35 ml

82371 160 ml

**Gourmetgläser, 12er Set**

gourmet glasses, 12 pcs.

tarros gourmet, set de 12

verres gourmet, set de 12



	Ø cm	↑ cm	ltr.	pcs
82359	5	3,5	0,035	12
82370	6	5,5	0,08	12
82371	6	8,0	0,16	12

**12er Set, ohne Deckel**

12 pcs., without covers



**Serviergestell „WECK“**

serving stand  
expositor  
présentoir  
**ohne Gläser**  
without glasses  
sin vasos  
sans verrines



	Ø cm	↑ cm	
33246	22	59	12 x Ø 6 cm

passende Gläser / matching glasses / vasos a juego / verrines approprié



	Ø cm	↑ cm	ltr.	pcs
82310	6	5,5	0,08	12
82312	6	7,0	0,14	12
82314	6	8,0	0,16	12



**Weck-Frischhaltedeckel, 5er Set**

airtight cover, 5 pcs.  
tapa hermética, set de 5  
couvercle hermétique, set de 5  
**für Rundrandgläser Ø 6 cm, 5er Set**  
for Ø 6 cm glasses, 5 pcs. set  
para vasos Ø 6 cm, set de 5  
pour verrines Ø 6 cm, set de 5



	Ø cm	pcs.
82338	7	5



**Gummidichtringe, 10er Set**

rubber washer, 10 pcs.  
juntas de goma, set de 10  
joints de caoutchouc, set de 10  
**für Deckel der Weck-Gläser, im Beutel verpackt**

for covers of Weck-glasses, packed in a bag  
para las tapas de los tarritos Weck, empaquetado en una bolsa  
pour la fermeture des verrines Weck, emballé dans un sac

	fits to	pcs.
82318	82307, 82308, 82309, 82310, 82312, 82314, 82316	10
82394	82345	10
82395	82346, 82347	10



**8er Set Deckel-Klammer für 4 Weck-Gläser**

8 pcs. cover clamps for 4 Weck-glasses  
8 abrazaderas para 4 vasitos Weck  
8 agrafes pour 4 verrines Weck

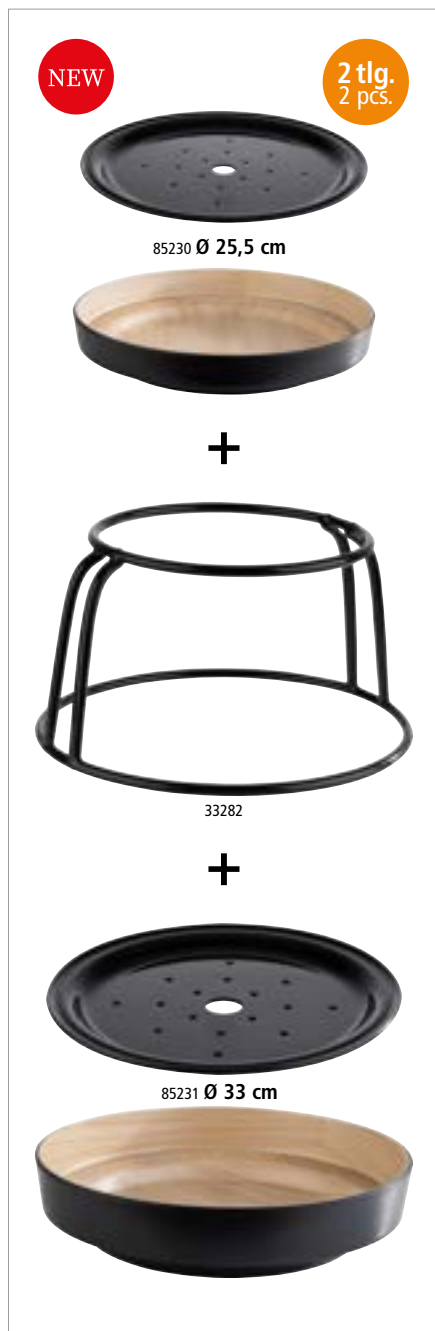

	pcs.
82319	8

**Schale, 2-teilig „FRIDA“**

bowl, 2 pcs.  
cuenco, set de 2  
bol, set de 2



**inklusive Abtropfeinsatz**  
including drip tray  
con bandeja recogegotas  
avec égouttoir

	Ø cm	↑ cm
85230	25,5	6
85231	33,0	6

**Buffetständer**

buffet stand  
soporte para buffet  
présentoir buffet



**Metall, mit schwarzer Antirutschbeschichtung, für Schalen Nr. 85230, 85231**

metal, with black anti-slide coating, for bowls no. 85230, 85231

metal, con revestimiento antideslizante negro, para cuencos 85230, 85231

métal, avec revêtement antidérapant noir, pour bols 85230, 85231

	Ø cm	↑ cm
33282	23 / 30,5	17

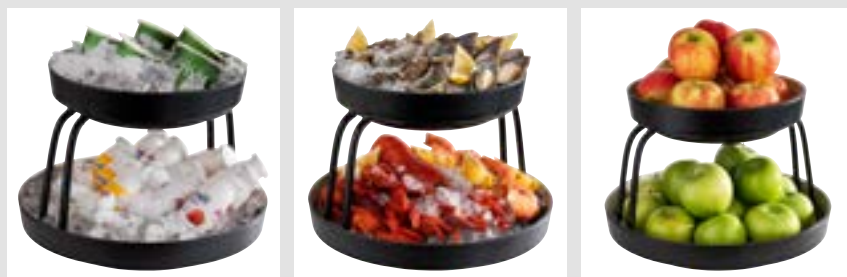

**Präsentationsmöglichkeit**  
presentation example



mit Abtropfeinsatz  
with drip tray



**Topf darf nicht erhitzt werden!**  
**Topf ist nicht zum Kochen geeignet!**

**Servier-Muscheltopf**

serving mussel pot  
mejillonera para servir  
casserole à moules pour servir

**schwarz emailliertes Stahlblech, mit Edelstahlrand**

black enamelled steel, stainless steel rim

hierro esmaltado negro, borde inox

acier émaillé noir, bord inox



	Ø cm	↑ cm	Topf / pot ltr.	Deckel / lid ltr.
00623	13,5	9,0	0,75	0,60
00625	18,0	12,0	2,60	1,40
00626	20,0	13,0	3,30	1,60
00627	24,0	13,5	5,20	2,70

# CAKE STANDS



**Servier- und Tortenplatte „CASUAL“**  
 cake plate  
 porta pasteles  
 présentoir à gâteaux



	Ø cm	↑ cm
83890	31	8
83891	31	16
	cm	↑ cm
83892	31 x 31	8
83893	31 x 31	16



**Servier- und Tortenplatte**  
 cake stand  
 porta pasteles  
 présentoir à gâteaux



**Rand fixiert die Haube, mit Antirutschfüßchen**  
 carved edge fixes the cover, with non-slip feet  
 ranura para fijar bien la campana, con pies antideslizantes  
 bord rainuré pour maintenir ferme la cloche, avec pieds antidérapants



	Ø cm	↑ cm	Farbe / Colour	fits to cover
00468	31	3,5	White	06520
00469	31	3,5	Black	06520



**Servier- und Tortenplatte**  
 cake stand  
 porta pasteles  
 présentoir à gâteaux



**Eichenholz geölt, mit Safrinne**  
 oak wood oiled, with juice groove  
 madera de roble aceitada, mit Safrinne  
 bois de chêne huilé, mit Safrinne

	Ø cm	↑ cm
00818	32	2,0

**passende Hauben / suitable for covers / campanas adecuadas / cloches appropriées**

	Ø cm	↑ cm
06520	30	22
06510	30	11,5



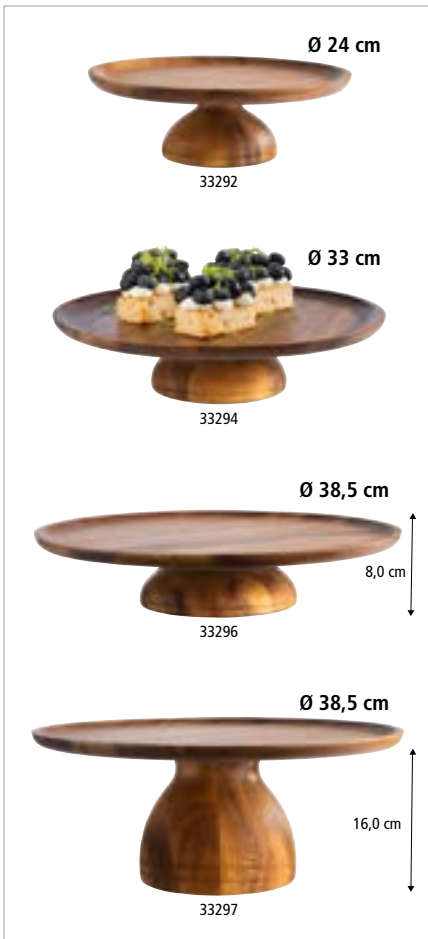

**Servier- und Tortenplatte „ACACIA“**

cake stand  
porta pasteles  
présentoir à gâteaux

**Akazienholz geölt, möbelschonende Unterseite**  
acacia wood oiled, furniture-friendly underside  
madera de acacia aceitada, con base anti rayaduras  
bois d'acacia huilé, avec revêtement antirayures



	Ø cm	↑ cm
33292	24,0	8
33293	24,0	16
33294	33,0	8
33295	33,0	16
33296	38,5	8
33297	38,5	16

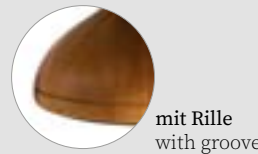

mit Rille  
with groove

**Frischhaltehaube / cover / campana / cloche**



	Ø cm	↑ cm	fits to
06519	21	17	33292, 33293
06520	30	22	33294, 33295
06521	36	27	33296, 33297



drehbar  
rotating

**Servier- und Tortenplatte**

cake stand  
porta pasteles  
présentoir à gâteaux

**matt poliert, drehbar, möbelschonende Unterseite**  
matt polished, rotating, furniture-friendly underside  
acabado pulido satinado, giratorio, base revestida de goma para no rallar el mobiliario  
poli satiné, plateau tournant, avec revêtement antirayures



	Ø cm	↑ cm
00463	30,5	9



**Servier- und Tortenplatte**

cake stand  
porta pasteles  
présentoir à gâteau

**matt poliert / matt polished / acabado efecto satinado / poli mat poli mat**



	Ø cm	↑ cm
00046	31	3

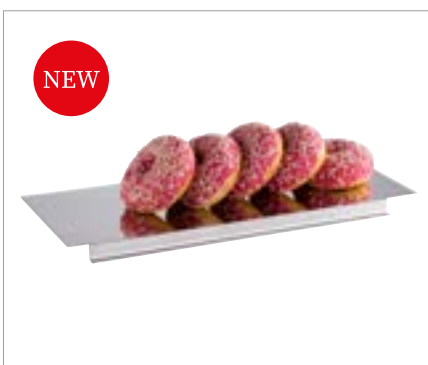

**Auslagen- / Kuchenplatte**

display / cake plate  
expositor / plato para tartas  
présentoir / assiette à gâteau

**ideale Größe für Baumkuchen / Stollen**  
ideal size for Baumkuchen / Stollen  
tamaño ideal para Baumkuchen / Stollen  
taille idéale pour Baumkuchen / Stollen



	cm	↑ cm
00047	40 x 16	2,5

# SUPER DOME



## Frischhaltehaube „SUPER DOME“

cover  
campana  
cloche



schwere, glasklare Qualität  
stable, crystal clear quality  
muy resistente y transparencia cristalina  
haute résistance et transparence

	Ø cm	↑ cm
06525	30	40

passende Servier-/Tortenplatten / suitable cake stands / porta pasteles compatibles / présentoirs à gâteaux compatibles

	Ø cm	↑ cm	fits to	Farbe / Colour
00468	31,0	3,5	06525	
33294	33,0	8,0	06525	
33295	33,0	16,0	06525	

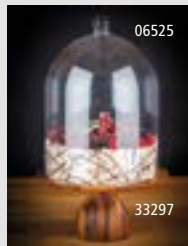

Präsentationsmöglichkeiten  
presentation examples



## Frischhaltehaube

cover  
campana  
cloche



schwere, glasklare Qualität  
stable, crystal clear quality  
calidad estable y transparencia cristalina  
qualité stable et clarté cristalline

	Ø cm	↑ cm	fits to
06519	21	17	84941, 84942
06520	30	22	85034, 84177, 83891, 83890, 83884, 998, 975, 469, 468, 463, 462, 46
06521	36	27	84945, 84946

# GRAVY BOATS



## Sauciere „PROFI“

gravy boat  
salsera  
saucière

hochglanzpoliert, extra schwere Qualität  
mirror polished, high quality  
pulido brillante, alta calidad, base pesada  
poli brillant, belle qualité, pied pesant



	cm	↑ cm	ltr.
40208	13 x 6,0	9,0	0,075
40204	16 x 7,5	9,0	0,125
40205	19 x 9,0	13,0	0,25
40206	22 x 10,5	13,5	0,4



## Sauciere „ECO“

gravy boat  
salsera  
saucière

hochglanzpoliert  
mirror polished  
pulido brillante  
poli brillant



	cm	↑ cm	ltr.
40200	18,0 x 7,5	7,0	0,10
40203	21,5 x 9,5	8,5	0,15
40201	23,5 x 10,0	10,0	0,20
40202	23,5 x 12,0	12,0	0,45

## PLATE TRAYS



### Thermo-Sauciere

insulated sauce boat  
salsera isotérmica  
sauceière thermique



**doppelwandig, Klappdeckelverschluss, Einhandbedienung**

double wall, hinged cover, one-hand operation

doble pared, tapa con bisagra, se maneja con 1 mano

double paroi, couvercle avec charnière, usage 1 main

	cm	↑ cm	ltr.
40207	19 x 12,5	13	0,4



### Glocke

cloche / dome cover  
campana esférica  
cloche demi-sphère



**außen hochglanzpoliert, innen matt poliert, mit verchromten Griff**

outside mirror polished, inside matt polished, with chromeplated handle

exterior pulido brillante, interior pulido mate, pomo cromado

extérieur poli brillant, intérieur poli mat, buton chromé

	Ø cm	↑ cm
35734	29	18



### Platzteller

plate tray  
bajo plato  
assiette de présentation



**hochglanzpoliert, mit Fadendekor**

mirror polished, with line edge

pulido brillante, con un filo en relieve

poli brillant, filet relief

	Ø cm
35730	30,5
36233	33,0



### Platzteller

plate tray  
bajo plato  
assiette de présentation



**hochglanzpoliert, mit Perlrand**

mirror polished, with pearl edge

acabado pulido brillante, con borde aperlado

poli brillant, bord perlé

	Ø cm
35720	30,5
36323	33,0



### Tischkrümelentferner

crumber  
recogemigas  
ramasse-miettes



**matt poliert, geschliffene Edelstahlkante**

matt polished, flat grinded stainless steel edge

pulido mate, borde plano de acero inoxidable rectificad

poli mat, bord plat rectifié en acier inox

	cm	↑ cm
00581	19,0 x 4,5	1



**Untersetzer, 6er Set**

coaster, 6 pcs.  
posavasos, set de 6  
plateau sous-verre, set de 6

hochglanzpoliert, schwere Ausführung, Rand eingerollt  
mirror polished, heavy quality, rolled edge  
pulido brillante, alta calidad, borde redondeado  
poli brillant, bord rond, qualité extra



	Ø cm	pcs.
35711	10	6
35912	12	6



**Untersetzer, 6er Set**

coaster, 6 pcs.  
posavasos, set de 6  
plateau sous-verre, set de 6



	Ø cm	pcs.
35716	11	6



**Serviettenringe, 4er Set**

napkin rings, 4 pcs.  
servilleteros, set de 4  
anneaux porte-serviette, set de 4



	Ø cm	↑ cm	pcs.
04446	4,5	2,5	4



**Rechnungstablett**

bill presenter  
porta cuenta  
porte-addition  
mit Klemme für Rechnung  
with clip for bill  
con clip para la nota  
avec clip pour la note



	cm	↑ cm
30110	17 x 11	1,0



**Rechnungstablett**

bill presenter  
porta cuenta  
porte-addition  
mit Klemme für Rechnung  
with clip for bill  
con clip para la nota  
avec clip pour la note



	cm	↑ cm
30108	20 x 12	0,5



**Besteckkorb „ECONOMIC“**  
 cutlery dispenser  
 dispensador de cubiertos  
 corbeille à couverts



	Ø cm	↑ cm	Farbe / Colour
40130	12	15	
40007	12	15	
40012	12	15	
40013	12	15	



**Besteckkorb „ECONOMIC“**  
 cutlery dispenser  
 dispensador de cubiertos  
 corbeille à couverts



	cm	↑ cm	Farbe / Colour
40131	27 x 10	4,5	
40009	27 x 10	4,5	
40010	27 x 10	4,5	
40011	27 x 10	4,5	



**Besteckständer**  
 cutlery basket  
 porta cubiertos  
 porte-couverts



**Behälter aus Edelstahl, matt poliert**  
 container made of stainless steel, matt polished  
 contenedor de acero inoxidable, pulido mate  
 conteneur en acier inox, poli mat

	Ø cm	↑ cm
11921	10	10,0
11922	12	13,5



**Besteckbehälter „ELEMENT“**

cutlery bin  
recipiente para cubiertos  
récipients pour couverts

mit Abflussloch, mit Besteck Logo, Bodeneinlagen aus Silikon zum Schonen des Bestecks, möbelschonende Unterseite

with drain hole, with cutlery logo, silicone floor inserts for saving the points of knives, furniture-friendly underside

con orificio de drenaje, con logotipo de cubertería, soporte de silicona para proteger las puntas de los cuchillos, con base antirrayaduras

avec le trou de drainage, avec le logo de coutellerie, insert de silicone pour protéger les pointes des couteaux, avec base revêtue antirayures



	Ø cm	↑ cm
00018	11	14



11998  
Köcher weiß

11999  
Köcher Edelstahl

**Besteckköcher**

cutlery basket  
cesta para cubiertos  
corbeille à couverts

Kunststoff weiß / white plastic / plástico blanco / plastique blanc



	Ø cm	↑ cm
11998	9,5	13,5

matt poliert / matt polished / pulido mate / poli mat

	Ø cm	↑ cm
11999	9,5	13,5



00025

00026

**Tischreste-/ Besteckbehälter „TOP CHROME“**

table waste bin / cutlery bin  
papelera de sobremesa / recipiente para cubiertos  
poubelle de table / récipients pour couverts

mit verchromten Rand / with chrome plated ring / con anillo cromado / avec bord chromé



	Ø cm	↑ cm	ltr.	Farbe / Colour
00025	13	15	1	White
00026	13	15	1	Black



00019

00020

**Tischreste-/ Besteckbehälter „BASE CHROME“**

table waste bin / cutlery bin  
papelera de sobremesa / recipiente para cubiertos  
poubelle de table / récipients pour couverts

mit verchromten Boden / with chrome bottom / con base cromada / avec base chromée



	Ø cm	↑ cm	ltr.	Farbe / Colour
00019	13	15	1,3	White
00020	13	15	1,3	Black



**Tischreste-/ Besteckbehälter**

table waste bin / cutlery bin  
papelera de sobremesa / recipiente para cubiertos  
poubelle de table / récipients pour couverts

mit verchromten Rand, inklusive herausnehmbarem Einteiler (4 Fächer)

with chrome plated ring, including devider (4 chambers)

con anillo cromado, incluyendo devider (4 cámaras)

avec bord chromé, y compris devider (4 chambres)



	cm	↑ cm	Farbe / Colour
00016	14 x 14	16	Black



**Table Caddy „COUNTRY STYLE“**

table barrel  
caddy de mesa  
caddy de table



**cooler Country-Style, nicht für den direkten Kontakt mit Lebensmittel verwendbar**

condiment and cutlery holders or even for food presentation, the mini barrels should not come into contact with food, they should be lined with our greaseproof paper

estilo campestre, no aptos para el contacto directo con alimentos, sólo usando papel alimenticio

de style champêtre, pas de contact direct avec aliments, seulement en utilisant papier alimentaire

	Ø cm	↑ cm
11930	17,5	8,5
11931	11,5	14,0



**Tischrestebehälter**

table garbage bin  
papelera de sobremesa  
poubelle de table



	Ø cm	↑ cm	ltr.	Farbe / Colour
02038	11	14	0,9	White
02039	11	14	0,9	Black



**Tischrestebehälter**

table garbage bin  
papelera de sobremesa  
poubelle de table



	Ø cm	↑ cm	ltr.
00311	14	15	1,2



**Tischrestebehälter**

table garbage bin  
papelera de sobremesa  
poubelle de table



**Kunststoff weiß / granit, abnehmbarer Schwingdeckel**

white plastic, swing cover, cover removable

plástico blanco/granito, tapa basculante desmontable

plastique blanc/gris chiné, couvercle basculant démontable

	Ø cm	↑ cm	ltr.
00031	12	18	1,4



**Tischrestebehälter**

table garbage bin  
papelera de sobremesa  
poubelle de table



**matt poliert, abnehmbarer Schwingdeckel, mit Bajonettverschluss**

matt polished, swing cover, cover removable, with bayonet lock

pulido mate, tapa basculante desmontable, con cierre de bayoneta

poli mat, couvercle basculant démontable, avec fermeture à baïonnette

	Ø cm	↑ cm	ltr.
00029	12	17	1,2
00027	10	13	0,7



# MENU HOLDERS



zum Einschieben der Speisekarten – schneller Austausch jederzeit möglich!  
for inserting the menus - quick exchange possible at any time!



Der Kartenhalter ist völlig unkompliziert zu handhaben, denn er verfügt über eine Vorrichtung, in die die Karten einfach eingeschoben und schnell ausgetauscht werden können.

The menu holder is completely uncomplicated to handle, because it has a device into which the cards can simply be inserted and quickly exchanged.

El uso del porta menús es totalmente sencillo, ya que dispone de un dispositivo en el que simplemente se introducen las tarjetas y se intercambian rápidamente.

L'utilisation du porte-cartes est très simple, car il dispose d'un dispositif dans lequel les cartes peuvent être simplement insérées et rapidement échangées.



2 tlg.  
2 pcs.

DIN A6

71521

## Kartenhalter 2-teilig

menu holder, 2 pcs.  
porta menús, set de 2  
porte-cartes, set de 2

Fuß aus Edelstahl, Menühalter aus Acryl  
stainless steel base, menu holder made of acrylic  
base de acero inoxidable, porta menús acrílico  
base en acier inox, porte-cartes en acrylique



	cm	↑ cm		
71521	10,5 x 7	17	stainless steel	
71527	10,5 x 7	17	black	



2 tlg.  
2 pcs.

DIN A5

71528

## Kartenhalter 2-teilig

menu holder, 2 pcs.  
porta menús, set de 2  
porte-cartes, set de 2

Fuß aus Edelstahl, Menühalter aus Acryl  
stainless steel base, menu holder made of acrylic  
base de acero inoxidable, porta menús acrílico  
base en acier inox, porte-cartes en acrylique



	cm	↑ cm		
71522	15 x 7	23	stainless steel	
71528	15 x 7	23	black	



2 tlg.  
2 pcs.

DIN A4

71523

## Kartenhalter 2-teilig

menu holder, 2 pcs.  
porta menús, set de 2  
porte-cartes, set de 2

Fuß aus Edelstahl, Menühalter aus Acryl  
stainless steel base, menu holder made of acrylic  
base de acero inoxidable, porta menús acrílico  
base en acier inox, porte-cartes en acrylique



	cm	↑ cm		
71523	21 x 7	32	stainless steel	
71529	21 x 7	32	black	

## MENU HOLDERS

**NEW**



**2 tlg.  
2 pcs.**

71520

### Mini Staffelei, 2 teilig

easel mini, 2 pcs.  
caballete mini, set de 2  
chevale mini, set de 2



**Ständer aus Akazienholz, Schild kann senkrecht oder waagrecht verwendet werden**

acacia wood stand, sign can be used vertically or horizontally

soporte de madera de acacia, el cartel se puede utilizar vertical u horizontalmente

support en bois d'acacia, le panneau peut être utilisé verticalement ou horizontalement

	cm	↑ cm
71520	13,5 x 10,0	19
71531 <b>NEW</b>	19,5 x 15,0	24



**waagrecht**  
horizontal



**senkrecht**  
vertical



**71490 Kreide-Marker**  
chalk marker

**Inhalt ohne Stift**  
content without pen



**2 tlg.  
2 pcs.**



71496



71497

### Kartenhalter „ELEMENT“, 2 teilig

menu holder, 2 pcs.  
soporte de tarjeta de menú, set de 2  
porte-cartes de menu, set de 2



**Fuß aus Beton, Menühalter aus Acryl**

concrete base, acrylic menu sign / holder

base de hormigón, letrero de menú acrílico

socle en béton, plaque de menu en acrylique

	cm	↑ cm
71496	11,5 x 4,5	10
71497	15,5 x 6,5	26

### Kartenhalter-Set

card holder set  
portatarjetas, set  
porte-cartes, set



**18-teilig: 6 Kartenhalter 4 x 2,5 cm + 12 Kunststoff-Beschriftungskarten 10 x 6 cm**

18 pcs.: 6 card holder 4 x 2,5 cm + 12 plastic cards of inscription 10 x 6 cm

set de 18: 6 soportes 4 x 2,5 cm + 12 tarjetas de plástico 10 x 6 cm

set de 18: 6 supports 4 x 2,5 cm + 12 étiquettes en plastique 10 x 6 cm

	cm
00022	4 x 2,5



**6 Stck. Halter**  
**12 Stck. Karten**



**Kartenhalter, 4er Set**

table stands, 4 pcs.  
portatarjetas, set de 4  
porte-cartes, set de 4

hochglanzpoliert, inklusive 20 schwarze Beschriftungskarten aus Polypropylen  
mirror polished, including 20 black cards made of polypropylene  
pulido brillante, incluye 20 tarjetas negras de polipropileno  
poli miroir, inclut 20 étiquettes noires en polypropylène



	Ø cm	↑ cm	pcs.	Farbe / Colour
71510	5	10,5	4	stainless steel
71513	5	15,5	4	stainless steel
71516	5	20,5	4	stainless steel



**Kartenhalter, 4er Set**

table stands, 4 pcs.  
portatarjetas, set de 4  
porte-cartes, set de 4

hochglanzpoliert, inklusive 20 schwarze Beschriftungskarten aus Polypropylen  
mirror polished, including 20 black cards made of polypropylene  
pulido brillante, incluye 20 tarjetas negras de polipropileno  
poli miroir, inclut 20 étiquettes noires en polypropylène



	Ø cm	↑ cm	pcs.	Farbe / Colour
71512	5	10,5	4	gunmetal



**Beschriftungskarten, 10er Set**

designation cards, 10 pcs.  
tarjetas, set de 10  
étiquettes, set de 10



	cm	✱ mm	pcs.
00037	7,5 x 5	0,4	10



**Bankettkartenständer**

menu stand / table number  
porta-etiqueta o carta de sobremesa  
porte-étiquette de table, porte-menu, ou n° de table

hochglanzpoliert, schwere Qualität  
mirror polished, heavy gauge  
pulido brillante, alta calidad  
poli brillant, belle qualité



	Ø cm	↑ cm
71460	7,5	18,5
71461	7,5	29



**Tischkartenhalter, 4er Set**

table stands, 4 pcs.  
pinzas porta-etiquetas, set de 4  
porte-étiquettes à pince, set de 4

hochglanzpoliert, schwerer Fuß, inklusive 20 weiße Beschriftungskarten  
mirror polished, heavy foot, including 20 white labels  
pulido brillante, incluye 20 etiquetas en blanco  
poli brillant, inclut 20 étiquettes blanches



	Ø cm	↑ cm	pcs.
00070	4	10	4

## MENU HOLDERS



### Tischaufsteller, 10er Set

table stands, 10 pcs.  
caballes de mesa, set de 10  
chevalets de table, set de 10



#### Ecken abgerundet

corners rounded  
esquinas redondeadas  
coins arrondies

	cm	↑ cm	pcs.
00011	7,5 x 3,5	5	10
00012	10,5 x 6	6,5	10



### Kartenhalter, 2er Set

card holder, 2 pcs.  
soporte de mesa, set de 2  
support de table, set de 2



#### inklusive 40 Beschriftungskarten, durch Magnete einfach zusammenklappbar

including 40 cards, easily foldable with magnets  
incluye 40 tarjetas, fácil de plegar, con imanes  
inclut 40 étiquettes, fácil à plier, avec aimants

	cm	↑ cm	pcs.
00076	9 x 3	5,5	2



### Kartenhalter, 2er Set

menu holder, 2 pcs.  
porta cartas de mesa, set de 2  
supports pour menu de table, set de 2



#### Rubberwood / rubber wood / madera de goma / bois d'hévéa

	cm	↑ cm	pcs.
00023	8,5 x 6	4,5 / 8,5	2



### Kartenhalter, 2er Set

menu holder, 2 pcs.  
porta cartas de mesa, set de 2  
porte-menus de table, set de 2



**matt poliert**  
matt polished  
pulido mate  
poli mat

	cm	↑ cm	pcs.
00021	8,5 x 4	4 / 8,5	2



**Tischkartenhalter**  
 table stand  
 soporte-carta para la mesa  
 support pour menu de table  
**matt poliert**  
 matt polished  
 pulido mate  
 poli mat



	cm	↑ cm	pcs.
00030	8 x 7,0	2	1
00036	6 x 4,5	4	1



**Kartenhalter-Set, 4er Set**  
 table stands, 4 pcs.  
 portatarjetas, set de 4  
 porte-cartes, set de 4  
**inklusive 30 Beschriftungskarten (15 x weiß + 15 x schwarz)**  
 including 30 labels ( 15 x white + 15 x black)  
 incluye 30 tarjetas (15 x blanco + 15 x negro)  
 inclut 20 étiquettes (15 x blanc + 15 x noir)



	cm	↑ cm	pcs.
71492	3 x 3	3	4
71493	3 x 3	3	4
71494	3 x 3	12	4



**Kartenhalter, 4er Set**  
 table stands, 4 pcs.  
 soportes de mesa, set de 4  
 upport de table, set de 4  
**inklusive 20 weiße Beschriftungskarten ca. 10 x 8 cm**  
 including 20 white labels 10 x 8 cm  
 incluye 20 etiquetas blancas 10 x 8 cm  
 20 étiquettes blanches incluses 10 x 8 cm



	cm	↑ cm	pcs.	Farbe / Colour
00074	3 x 3	12	4	light blue

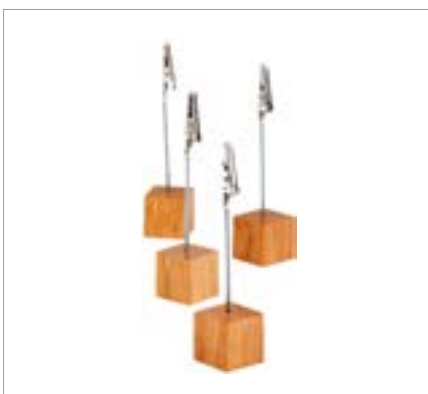

**Kartenhalter, 4er Set**  
 table stands, 4 pcs.  
 soportes de mesa, set de 4  
 support de table, set de 4  
**Rubberwood, inklusive 20 weiße Beschriftungskarten ca. 10 x 8 cm**  
 rubber wood, including 20 white labels 10 x 8 cm  
 madera de goma, incluye 20 etiquetas blancas 10 x 8 cm  
 bois d'hévéa, 20 étiquettes blanches incluses 10 x 8 cm



	cm	↑ cm	pcs.	Farbe / Colour
00700	2,5 x 2,5	12	4	light brown

## MENU HOLDERS



### Kartenhalter „WÜRFEL“, 4er Set

table stands, 4 pcs.  
soporte de mesa, set de 4  
porte-étiquettes, set de 4

**inklusive 20 weiße Beschriftungskarten ca. 10 x 8 cm, mehrfach beschriftbar**

including 20 white labels 10 x 8 cm, multiple inscribable  
incluye 20 etiquetas blancas 10 x 8 cm, inscribible múltiple  
20 étiquettes blanches incluses 10 x 8 cm, inscriptible multiple



	cm		pcs.
00078	3 x 3 x 3		4



### Kartenhalter „ZYLINDER“, 4er Set

table stands, 4 pcs.  
soporte de mesa, set de 4  
porte-étiquettes, set de 4

**inkl. 20 weiße Beschriftungskarten ca. 10 x 8 cm, mehrfach beschriftbar**

incl. 20 white labels 10 x 8 cm  
incluye 20 etiquetas blancas 10 x 8 cm  
20 étiquettes blanches incluses 10 x 8 cm



	cm		pcs.
00079	3 x 3 x 3		4



### Tafelhalter / Schild

slate sign  
caballete de mesa, pizarra  
plaque signalétique avec support



	cm	↑ cm	pcs.
00060	12 x 4	7	1



### Kartenhalter, 2er Set „KLAMMER“

table stand, 2 pcs.  
soporte de mesa, set de 2  
support de table, set de 2

**Kiefernholz, inklusive 30 Beschriftungskarten ca. 10 x 8 cm (15 x weiß, 15 x schwarz)**

pine wood, including 30 cards 10 x 8 cm (15 x white, 15 x black)  
madera de pino, incluye 30 tarjetas 10 x 8 cm (15 x blanco, 15 x negro)  
bois de pin, inclut 30 étiquettes 10 x 8 cm (15 x blanc, 15 x noir)



	cm	↑ cm	pcs.	Farbe / Colour
71487	4 x 2,5	10	2	
71489	4 x 2,5	10	2	

**Beschriftungskarten, 50 Stück / designation cards, 50 pcs. set**  
cartelitos de designación, 50 piezas / cartes de désignation, 50 pièces

	cm	pcs.	Farbe / Colour	fits to
71498	10 x 8	50		71487, 71489
71499	10 x 8	50		71487, 71489



**Kartenhalter, 2er Set**

table stands, 2 pcs.  
portatarjetas, set de 2  
porte-cartes, set de 2



inklusive 30 Beschriftungskarten ca. 10 x 8 cm (15 x weiß + 15 x schwarz)  
including 30 labels 10 x 8 cm (15 x white + 15 x black)  
incluye 30 tarjetas 10 x 8 cm (15 x blanco + 15 x negro)  
inclut 20 étiquettes 10 x 8 cm (15 x blanc + 15 x noir)

	cm	↑ cm	pcs.
71495	8 x 3,5	6	2



**Tischkartenhalter „PROFI“**

table stand  
soporte de mesa  
support de table



	cm	↑ cm
40425	9,5 x 7,5	13,5



**Tischkartenhalter**

table stand  
soporte de mesa  
support de table



**möbelschonende Unterseite**  
non-scratching undersurface  
con base antirrayaduras  
avec revêtement antirayures

	cm	↑ cm
00071	14 x 5,5	14

## MENU HOLDERS



71470

### Schilderhalter „FLEXIBEL“

sign holder  
soporte para cartelito  
support pour menu de table



**biegsamer Draht mit zwei Klemmen, extrem flexibel, die Klemmen lassen sich weit öffnen**  
bedable metal coil adds visual interest, two metal clip open  
metal cromado flexible, 2 pinzas con gran apertura  
métal chromé, flexible, 2 pinces à grande ouverture

	→ cm	
71470	12	ohne Schilder / without signs sin cartelitos / sans étiquette
71471	23	ohne Schilder / without signs sin cartelitos / sans étiquette
71480	12	inkl. 10 Schilder 11879 / incl. 10 signs 11879 con 10 cartelitos 11879 / avec 10 étiquettes 11879

Schilder, 10er Set / signs, 10 pcs. / set de 10 cartelitos / set de 10 étiquettes

	cm	
11879	7,7 x 5,2	
12879	5,0 x 3,0	

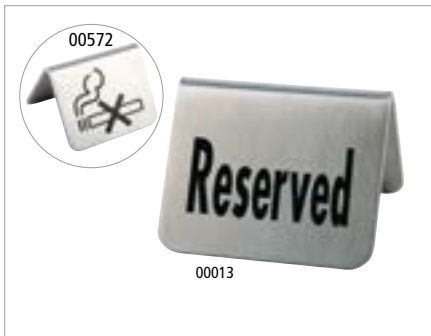

00013

### Tischaufsteller 2er Set

table stands, 2 pcs.  
caballetes de mesa, set de 2  
chevalets de table, set de 2



	cm	↑ cm		pcs.
00017	5,5 x 5	3,5	reserviert	2
00013	5,5 x 5	3,5	reserved	2
00572	5,5 x 5	3,5	no smoking	2



### Beschriftungsetiketten

labeling labels  
etiquetas  
étiquettes



**12 Bögen mit je 6 Motiven, selbstklebend, mit wasserlöslichem Stift beschreibbar**

12 sheets includes 6 self-adhesive and removable labels, use regular chalkboard markers and wipe clean with a damp cloth

12 hojas, cada una con 6 motivos autoadhesivos, se pueden marcar con un rotulador lavable con agua

12 feuilles chacune avec 6 motifs autoadhésifs, on peut écrire avec un stylo lavable à l'eau

	cm	Farbe / Colour
00069	8,0 x 4,5	■



### Kreide-Marker, Stärke 2 mm, 2er Set

chalk marker, 2 pcs.  
rotulador de tiza, set de 2  
marqueur a la craie liquide, set de 2



**Zum Gestalten und Beschriften von Tafeln, Glas und fast allen geschlossenen Oberflächen, deckende Flüssigkreide auf Wasserbasis, feucht abwischbar**

For decorating and writing on boards, glass and almost all non-porous surfaces, opaque water-based liquid chalk, wet-wipeable

Rotuladores para pizarra de tiza líquida para decorar y escribir sobre pizarras, cristales y casi todas las superficies no porosas. Tiza líquida opaca al agua que se pueda borrar con un trapo

Pour décorations et inscriptions sur tableaux, verre et presque toutes les surfaces non poreuses, craie liquide opaque à base d'eau, effaçable avec un chiffon humide

	Ø cm	↑ cm	Farbe / Colour	pcs.
71490	1	13	■	2
71491	1	13	■	2



NEW

# Der nachhaltige Mehrwegbecher – made in Germany



eco-friendly



Das Ribbendesign isoliert die Hitze – kein „Verbrennen“ der Finger möglich

The rib design insulates the heat - no „burning“ of the fingers possible

Mehrwegbecher individuell mit Ihrem Logo/Namen herstellbar ab 500 Stck. – sprechen Sie uns an!

Reusable cups can be individually produced with your logo/name. From 500 pieces - please contact us!

- ✓ aufsteckbarer Deckel mit Trinköffnung
- ✓ 100% recyclebar
- ✓ spülmaschinengeeignet
- ✓ stapelbar mit und ohne Deckel
- ✓ schwappsicher

- clip-on lid with drinking opening
- 100% recyclable
- dishwasher safe
- stackable with and without lid
- slosh-/leak-proof

NEW



## To Go Mehrwegbecher

To Go reusable cup  
vaso reutilizable To Go  
tasse réutilisable To Go

**Becher (ohne Deckel)**

cup (without cover)

vaso (sin tapa)

tasse (sans couvercle)



	Ø cm	↑ cm	ltr.	Farbe / Colour	VE / unit
66910	8,5	13,5	0,4		48
66911	8,5	13,5	0,4		48
66912	8,5	13,5	0,4		48
66913	8,5	13,5	0,4		48

### Deckel / cover / tapa / couvercle

	Ø cm	↑ cm	Farbe / Colour	VE / unit
66914	8,5	2,5		48
66915	8,5	2,5		48
66916	8,5	2,5		48
66917	8,5	2,5		48





# Körbe

baskets

cestas

corbeilles

PROFI LINE.....	308
GN LINE.....	312
ECONOMIC.....	314
BASKETS   COVERS.....	318
BASIC.....	319
BREAD BASKETS.....	320
SNACKHOLDERS.....	323
URBAN.....	324
SVART.....	325
STAINLESS STEEL BASKETS.....	326
BASKETS   RISERS.....	328
LUNCHBOXES.....	329
SUPERBOX.....	330

# PROFI LINE



**hellbeige** / light beige  
beis claro / beige clair

**beige** / beige  
beis / beige

**braun** / brown  
marrón / marron

**schwarz** / black  
negro / noir

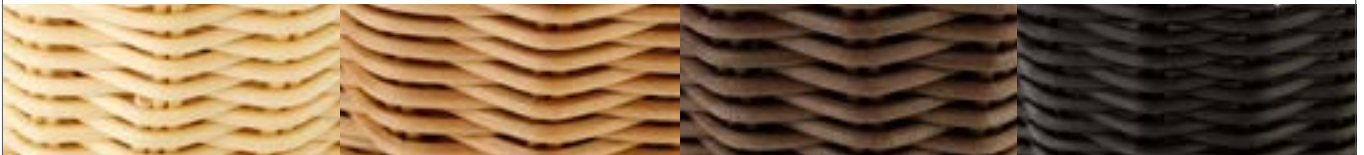

Korb "PROFI LINE"  
basket baker size  
cesta tamaño panaderia  
corbeille dimensions „boul-pâte“



	cm	↑ cm	Farbe / Colour
50915	60 x 40	5	hellbeige
50918	60 x 40	5	schwarz



Korb "PROFI LINE"  
basket baker size  
cesta tamaño panaderia  
corbeille dimensions „boul-pâte“



	cm	↑ cm	Farbe / Colour
50910	60 x 20	5	hellbeige
50913	60 x 20	5	schwarz



Korb "PROFI LINE"  
basket baker size  
cesta tamaño panaderia  
corbeille dimensions „boul-pâte“



	cm	↑ cm	Farbe / Colour
50905	40 x 30	5	hellbeige
50908	40 x 30	5	schwarz

	cm	↑ cm	Farbe / Colour
50710	40 x 30	10	hellbeige
50712	40 x 30	10	schwarz



**Systemkorb, gestäbt „PROFI LINE“**

basket  
cesta  
corbeille



	cm	↑ cm	Farbe / Colour
50305	45 x 40	27 / 16	



**Systemkorb „PROFI LINE“**

basket  
cesta  
corbeille



	cm	↑ cm	
50400	40 x 50	25 / 14	



**GN 1/1 Korb „PROFI LINE“**

GN 1/1 basket  
GN 1/1 cesta  
GN 1/1 corbeille



	cm	↑ cm	Farbe / Colour
50722	53 x 32,5	10	



**Korb, rund „PROFI LINE“**

basket, round  
cesta redonda  
corbeille ronde



	Ø cm	↑ cm	Farbe / Colour
50205	31 / 37	12 / 6	



**Korb, rund „PROFI LINE“**

basket, round  
cesta redonda  
corbeille ronde



	Ø cm	↑ cm	Farbe / Colour
50210	37	9	



**Korb, rechteckig „PROFI LINE“**

basket, rectangular  
cesta, rectangular  
corbeille, rectangulaire



	cm	↑ cm	Farbe / Colour
50702	26,5 x 19	7	

	cm	↑ cm	Farbe / Colour
50707	31 x 21	9	

## PROFI LINE



### Baguette Korb, oval „PROFI LINE“

baguette basket, oval  
cesta de baguette, oval  
corbeille à baguettes, ovale



	cm	↑ cm	Farbe / Colour
50805	28 x 16	8	
50806	28 x 16	8	
50808	28 x 16	8	
50807	28 x 16	8	

	cm	↑ cm	Farbe / Colour
50823	40 x 16	8	



### Korb, oval „PROFI LINE“

basket, oval  
cesta oval  
corbeille ovale



	cm	↑ cm	Farbe / Colour
50800	25 x 19	6,5	
50801	25 x 19	6,5	
50803	25 x 19	6,5	
50802	25 x 19	6,5	

	cm	↑ cm	Farbe / Colour
50815	32 x 23	7	
50817	32 x 23	7	



### Korb, rund „PROFI LINE“

basket, round  
cesta redonda  
corbeille ronde



	Ø cm	↑ cm	Farbe / Colour
50600	16	8	
50601	16	8	
50603	16	8	
50602	16	8	

	Ø cm	↑ cm	Farbe / Colour
50605	20	8	
50606	20	8	
50608	20	8	
50607	20	8	

	Ø cm	↑ cm	Farbe / Colour
50612	29	7	



### Korb, rechteckig „PROFI LINE“

basket, rectangular  
cesta rectangular  
corbeille rectangulaire



	cm	↑ cm	Farbe / Colour
50631	19 x 13	6	
50630	19 x 13	6	



50624

**Korb, oval „PROFI LINE“**

basket, oval  
cesta, oval  
corbeille, ovale



	cm	↑ cm	Farbe / Colour
50624	19 x 12	6	
50625	19 x 12	6	
50627	19 x 12	6	
50626	19 x 12	6	



50620

50621

50622

50623

**Korb, rund „PROFI LINE“**

basket, round  
cesta, redonda  
corbeille, ronde



	Ø cm	↑ cm	Farbe / Colour
50620	13	10	
50621	13	10	
50623	13	10	
50622	13	10	



**Auslage Tablett flach „PROFI LINE“**

display tray flat, baker size  
bandeja de presentación, tamaño panadería  
plateau de présentation, dimensions „boul-pâte“



	cm	↑ cm	Farbe / Colour
40296	40 x 30	1	
40297	60 x 40	1	

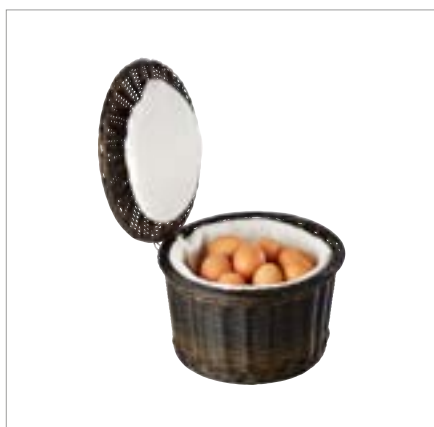

**Eierkorb „PROFI LINE“**

egg basket  
cesta de huevos  
panier à oeufs



**mit Edelstahldraht im Rand, für ca. 20 Eier, hält den Inhalt durch das Stofffutter lange warm**  
with stainless steel wire in the rim, for around 20 eggs, keeps the eggs warm thanks to the fabric lining  
**con alambre de acero inoxidable en el borde, para unos 20 huevos, mantiene los huevos calientes gracias al forro de tela**  
avec un fil d'acier inox dans la jante, pour env. 20 oeufs, garde les oeufs au chaud grâce à la doublure en tissu

	Ø cm	↑ cm	Farbe / Colour
40299	26	17	

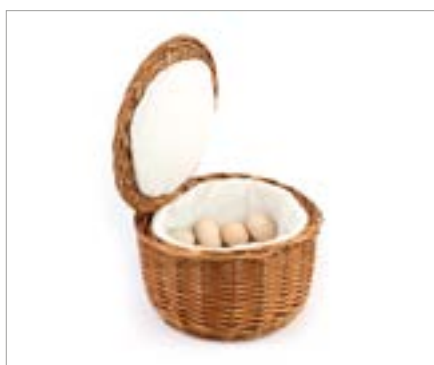

**Eierkorb**

egg basket  
cesta de huevos  
panier à oeufs



**stabile Vollweide, für ca. 20 Eier, hält den Inhalt durch das Stofffutter lange warm**  
stable willow, for around 20 eggs, keeps the eggs warm thanks to the fabric lining  
**sauce de estable, para unos 20 huevos, mantiene los huevos calientes gracias al forro de tela**  
saule stable, pour env. 20 oeufs, garde les oeufs au chaud grâce à la doublure en tissu

	Ø cm	↑ cm	Farbe / Colour
30299	26	17	

# GN LINE

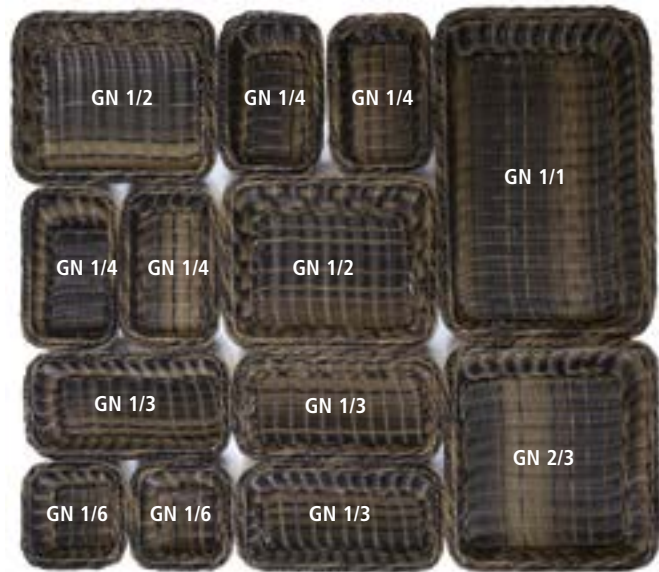

**2 Höhen - 6,5 und 10 cm**  
2 heights - 6,5 and 10 cm



40293  
GN 1/1 - 10 cm



40292  
GN 1/2 - 10 cm

40225  
GN 1/4 - 6,5 cm

## Korb „GN LINE“

GN basket

GN cesta

GN corbeille



**stabile Ausführung mit Edelstahldraht im Rand zur Stabilisierung**

very solid with stainless steel wire frame to stabilize the basket

muy resistente con refuerzo de alambre inox

très résistante avec son fil de renfort inox

	cm	↑ cm	GN	Farbe / Colour
40291	53,0 x 32,5	6,5	1/1	
40290	32,5 x 26,5	6,5	1/2	
40223	32,5 x 17,6	6,5	1/3	
40225	26,5 x 16,2	6,5	1/4	
40227	17,6 x 16,2	6,5	1/6	
40229	32,5 x 35,4	6,5	2/3	

	cm	↑ cm	GN	Farbe / Colour
40293	53,0 x 32,5	10,0	1/1	
40292	32,5 x 26,5	10,0	1/2	
40243	32,5 x 17,6	10,0	1/3	
40245	26,5 x 16,2	10,0	1/4	
40247	17,6 x 16,2	10,0	1/6	
40249	32,5 x 35,4	10,0	2/3	



GN 1/1

## GN 1/1 Besteckbehälter

GN 1/1 dispenser GN

GN 1/1 dispensador de cubiertos

GN 1/1 bac à couverts



**4 Mulden, Kunststoff-Geflecht, Drahtgestell, braun-schwarz**

4 compartments, with reinforced chromed wire structure, brown-black

4 compartimentos, de plástico, con bastidor cromado reforzado, marrón oscuro

4 compartiments, en plastique, cadre acier chromé renforcé, couleur marron foncé

	cm	↑ cm	GN	Farbe / Colour
11966	53 x 32,5	9	1/1	



# GN LINE

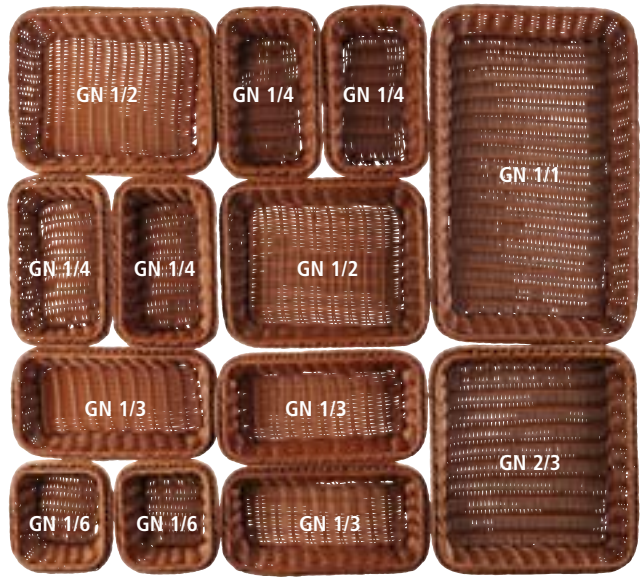

2 Höhen - 6,5 und 10 cm  
2 heights - 6,5 and 10 cm



40220 GN 1/1



40222 GN 1/2



40228 GN 1/6



40264 GN 1/4

40272 GN 1/2

## Korb „GN LINE“

GN basket  
GN cesta  
GN corbeille



stabile Ausführung mit Edelstahldraht im Rand zur Stabilisierung  
very solid with stainless steel wire frame to stabilize the basket  
muy resistente con refuerzo de alambre inox  
très résistante avec son fil de renfort inox

	cm	↑ cm	GN	Farbe / Colour
40220	53,0 x 32,5	6,5	1/1	Yellow
40222	32,5 x 26,5	6,5	1/2	Yellow
40224	32,5 x 17,6	6,5	1/3	Yellow
40226	26,5 x 16,2	6,5	1/4	Yellow
40228	17,6 x 16,2	6,5	1/6	Yellow
40230	32,5 x 35,4	6,5	2/3	Yellow
	cm	↑ cm	GN	Farbe / Colour
40240	53,0 x 32,5	10	1/1	Yellow
40242	32,5 x 26,5	10	1/2	Yellow
40244	32,5 x 17,6	10	1/3	Yellow
40246	26,5 x 16,2	10	1/4	Yellow
	cm	↑ cm	GN	Farbe / Colour
40260	53,0 x 32,5	6,5	1/1	Brown
40262	32,5 x 26,5	6,5	1/2	Brown
40263	32,5 x 17,6	6,5	1/3	Brown
40264	26,5 x 16,2	6,5	1/4	Brown
	cm	↑ cm	GN	Farbe / Colour
40270	53,0 x 32,5	10	1/1	Brown
40272	32,5 x 26,5	10	1/2	Brown
40274	32,5 x 17,6	10	1/3	Brown
40276	26,5 x 16,2	10	1/4	Brown

# ECONOMIC



Tisch- und Buffetkorb „ECONOMIC“  
buffet basket  
cesta de buffet  
corbeille de buffet



	Ø cm	↑ cm	Farbe / Colour
40132	19,0	9,5	Yellow
40135	25,5	8,5	Yellow
40144	39,0	10,0	Yellow
40191	19,0	9,5	Brown
40192	25,5	8,5	Brown

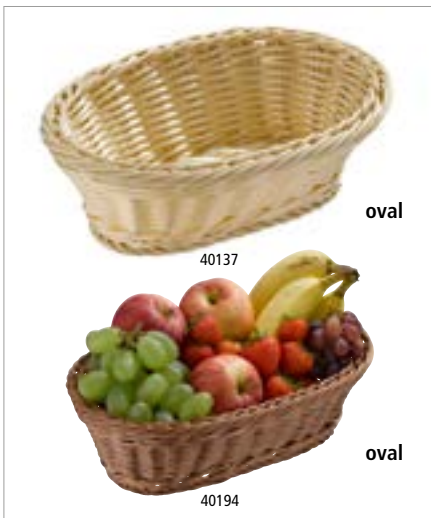

Tisch- und Buffetkorb „ECONOMIC“  
buffet basket  
cesta de buffet  
corbeille de buffet



	cm	↑ cm	Farbe / Colour
40137	23,0 x 17	8,0	Yellow
40139	28,5 x 17	8,5	Yellow
40193	23,0 x 17	8,0	Brown
40194	28,5 x 17	8,5	Brown



stapelbar  
stackable



Tisch- und Buffetkorb „ECONOMIC“  
buffet basket  
cesta de buffet  
corbeille de buffet



	cm	↑ cm	Farbe / Colour
40140	23,0 x 17	8	Yellow
40159	31,5 x 22	8,5	Yellow
40195	23,0 x 17	8	Brown
40196	31,5 x 22	8,5	Brown



GN Buffetkorb „ECONOMIC“  
GN basket  
GN cesta  
GN corbeille



	cm	↑ cm	GN	Farbe / Colour
40148	53 x 32,5	8	1/1	Yellow



GN Buffetkorb „ECONOMIC“  
GN basket  
GN cesta  
GN corbeille



	cm	↑ cm	GN	Farbe / Colour
40152	32,5 x 26,5	8	1/2	Yellow

**Buffetkorb „ECONOMIC“**

buffet basket  
cesta de buffet  
corbeille de buffet



**stabile Ausführung mit Edelstahldraht im Rand zur Stabilisierung**

very solid with stainless steel wire frame to stabilize the basket

muy resistente con refuerzo de alambre inox

très résistante avec son fil de renfort inox

	cm	↑ cm
40153	45 x 42	17 / 24



40149

**Buffetkorb, rund „ECONOMIC“**

buffet basket, round  
cesta de buffet, redonda  
corbeille de buffet ronde



**stabile Ausführung mit Edelstahldraht im Rand zur Stabilisierung**

very solid with stainless steel wire frame to stabilize the basket

muy resistente con refuerzo de alambre inox

très résistante avec son fil de renfort inox

	Ø cm	↑ cm	Farbe / Colour
40149	40	12,5	
40295	40	12,5	



18389

40295

**Rolltophaube mit verchromtem Kugelgriff / rolltop cover with chrome plated handle / campana abatible con pomo cromado / cloche basculante avec bouton chromé**

	Ø cm	↑ cm
18388	38	20

**Rolltophaube mit vergoldetem Kugelgriff / rolltop cover with gold plated handle / campana abatible con pomo dorado / cloche basculante avec bouton doré**

	Ø cm	↑ cm
18387	38	20

**Rolltophaube mit verchromtem Designergriff / rolltop cover with chrome plated designer handle / campana abatible con pomo de diseño cromado / cloche basculante avec bouton design chromé**

	Ø cm	↑ cm
18389	38	20



11010

40150

**Buffetkorb „ECONOMIC“**

buffet basket  
cesta de buffet  
corbeille buffet



**stabile Ausführung, Edelstahl Fixierungsrahmen, zur Rutschsicherung, ohne Haube**

stainless steel fix the cover, without cover

con marco cromado patentado para fijar y encajar la campana (se entrega sin la campana)

cadre fil acier inoxydable pour fixer la cloche (livré sans la cloche)

	cm	↑ cm	Farbe / Colour
40150	56,5 x 36	10	
40294	56,5 x 36	10	



11018

40294

**GN 1/1 Rolltop-Haube / GN 1/1 rolltop cover / GN 1/1 campana abatible / GN 1/1 cloche basculante**

	cm	↑ cm	GN	
11008	53 x 32,5	19	1/1	vergoldeter Griff / gold plated handle pomo dorado / bouton doré
11010	53 x 32,5	19	1/1	verchromter Griff / chrome plated handle pomo cromado / bouton chromé
11018	53 x 32,5	17	1/1	mit verchromtem Designergriff with chrome plated designer handle

## ECONOMIC



### Buffetgestell „DOPPELDECKER“ für GN

buffet frame for GN  
estructura para buffet para GN  
support buffet pour GN



2-teilig, einfach zusammensetzbar, Etagen-Abstand 26 cm, platzsparend, stabile Ausführung

2 pcs., easy to assemble, distance between the tiers 26 cm, space-saving, robust

2 pzas, fácil de montar, distancia entre pisos 26 cm, robusto

2 pcs, assemblage facile, distance entre niveaux 26 cm, robuste

	cm	↑ cm	fits to GN
11555	50 x 34	37,5	1/1



### GN Kuppelhaube

GN cover  
GN cúpula  
GN cloche bombée



glasklarer Kunststoff, Griff aus Zinkdruckguss

crystal clear plastic, die-cast zinc knob

plástico transparente, asa de zinc fundido a presión

plastique transparente, poignée en zinc moulé sous pression

	cm	↑ cm	GN	
11026	54 x 33	20	1/1	geschlossen / totally closed cerrada / totalmente fermée
11027	54 x 33	20	1/1	mit Front-Ausschnitt / one long side cut out gran apertura frontal / grande ouverture frontale
11028	54 x 33	20	1/1	mit seitlichem Ausschnitt / one small side cut out / pequeña apertura lateral / petite ouverture latérale



### GN Kuppelhaube

GN cover  
GN cúpula  
GN cloche bombée



glasklarer Kunststoff, Griff aus Zinkdruckguss

crystal clear plastic, die-cast zinc knob

plástico transparente, asa de zinc fundido a presión

plastique transparente, poignée en zinc moulé sous pression

	cm	↑ cm	GN	
11070	54 x 33	20	1/1	geschlossen / totally closed cerrada / totalmente fermée
11071	54 x 33	20	1/1	mit Front-Ausschnitt / one long side cut out gran apertura frontal / grande ouverture frontale
11072	54 x 33	20	1/1	mit seitlichem Ausschnitt / one small side cut out / pequeña apertura lateral / petite ouverture latérale



### Baguettekorb „ECONOMIC“

baguette basket  
cesta para baguette  
corbeille pour baguettes



stabile Ausführung mit Edelstahldraht im Rand zur Stabilisierung

very solid with stainless steel wire frame to stabilize the basket

muy resistente con refuerzo de alambre inox

très résistante avec son fil de renfort inox

	Ø cm	↑ cm	Farbe / Colour
40198	35	24 / 42	Yellow



**Besteckkorb „ECONOMIC“**

cutlery dispenser  
dispensador de cubiertos  
corbeille à couverts



4 Fächer (3 kleine und 1 großes) / 4 compartments (3 small and 1 large) /  
4 compartimentos (3 pequeños y 1 grande) / 4 compartiments (3 petits et 1 grand)

	cm	↑ cm	Farbe / Colour
40179	26 x 18	15	
40182	26 x 18	15	



**Besteckkorb „ECONOMIC“**

cutlery dispenser  
dispensador de cubiertos  
corbeille à couverts



	Ø cm	↑ cm	Farbe / Colour
40130	12	15	
40007	12	15	
40012	12	15	
40013	12	15	



**Besteckkorb „ECONOMIC“**

cutlery dispenser  
dispensador de cubiertos  
corbeille à couverts



	cm	↑ cm	Farbe / Colour
40131	27 x 10	4,5	
40009	27 x 10	4,5	
40010	27 x 10	4,5	
40011	27 x 10	4,5	



**Brot- und Obstkorb „WICKER LOOK“**

basket for bread or fruits  
cesta para pan o fruta  
corbeille à pain ou à fruits



	cm	↑ cm	Farbe / Colour
40214	Ø 20	6,5	■
40216	23 x 17	6,5	■

	cm	↑ cm	Farbe / Colour
40211	39,5 x 29,5	10	■
40212	39,5 x 29,5	10	■
40210	39,5 x 29,5	10	■



**GN 1/1 Korb „SUPERSTRONG“**

GN 1/1 basket  
GN 1/1 cesta  
GN 1/1 corbeille



	cm	↑ cm	GN	Farbe / Colour
50644	53 x 32,5	10,0	1/1	■

GN Kuppelhaube / GN cover / GN cúpula / GN cloche bombée

	cm	↑ cm	GN
11027	54 x 33	20	1/1



passend zu Regalwagen 71441, S. 365  
suitable for trolley 71441, S. 365



**GN Kuppelhaube**

GN cover  
GN cúpula  
GN cloche bombée



glasklarer Kunststoff, Griff aus Zinkdruckguss

crystal clear plastic, die-cast zinc knob

plástico transparente, asa de zinc fundido a presión

plastique transparente, poignée en zinc moulé sous pression

	cm	↑ cm	GN	
11070	54 x 33	20	1/1	geschlossen / totally closed cerrada / totalmente fermée
11071	54 x 33	20	1/1	mit Front-Ausschnitt / one long side cut out gran apertura frontal / grande ouverture frontale
11072	54 x 33	20	1/1	mit seitlichem Ausschnitt / one small side cut out / pequeña apertura lateral / petite ouverture latérale



**GN Abdeckhaube**

GN cover  
GN cubierta  
GN cloche



passend für GN 1/1 Körbe, glasklarer Kunststoff, nahezu bruchfest

suitable for GN 1/1 baskets, clear plastic, nearly unbreakable

apto para cestas GN 1/1, plástico transparente, muy resistente a la rotura

pour bacs et corbeilles GN 1/1, plastique transparent, très résistant à la casse

	cm	↑ cm	mm	GN
11042	53,0 x 32,5	9,5	3	1/1

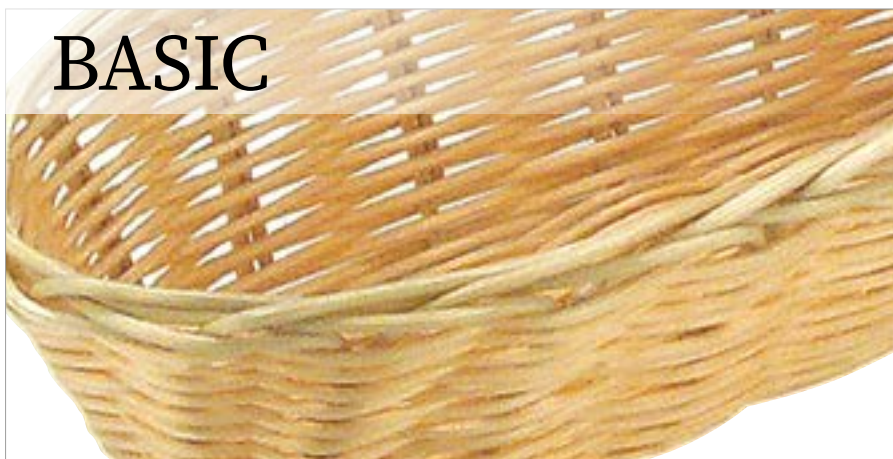

- in Handarbeit geflochten
- einfache und leichte Ausführung
- wickerwork
- simple and light version
- ligera
- tressada a mano
- tressé à main
- version légère



oval

**Brot- und Obstkorb „BASIC“**

basket for bread or fruits  
cesta para pan o fruta  
corbeille à pain ou à fruits



	cm	↑ cm
30279	18 x 12	7
30280	23 x 15	6



oval

**Brot- und Obstkorb „BASIC“**

basket for bread or fruits  
cesta para pan o fruta  
corbeille à pain ou à fruits



	cm	↑ cm
30282	21 x 10	6



rund

**Brot- und Obstkorb „BASIC“**

basket for bread or fruits  
cesta para pan o fruta  
corbeille à pain ou à fruits



	Ø cm	↑ cm
30281	20	7
30285	25	7



rechteckig

**Tisch- und Buffetkorb „BASIC“**

buffet basket  
cesta de buffet  
corbeille de buffet



	cm	↑ cm
30286	30 x 22	7
30283	22 x 15	6

# BREAD BASKETS



Umgekrempelt kann die Höhe individuell gestaltet werden!  
Adjustable height by turning the edge upside down!  
Altura ajustable girando el borde al revés!  
Hauteur ajustable en tournant le bord à l'envers!



## Brottasche bread basket panera corbeille



eckig, 70% Naturfaser und 30% Kunstharz  
angular, 70% natural fibre and 30% synthetic resin  
ángulo, 70% fibra natural y 30% resina sintética  
carré, 70% de fibres naturelles et 30% de résine synthétique

	cm	↑ cm	Farbe / Colour
30355	12 x 11,5	11,5	■
30356	12 x 11,5	11,5	■

rund, 70% Naturfaser und 30% Kunstharz  
round, 70% natural fibre and 30% synthetic resin  
redondo, 70% fibra natural y 30% resina sintética  
ronde, 70% de fibres naturelles et 30% de résine synthétique

	Ø cm	↑ cm	Farbe / Colour
30440	17	11	■
30450	20	13	■
30442	24	24	■
30443	30	22	■
30441	17	11	■
30451	20	13	■
30445	24	24	■
30446	30	22	■

oval, 70% Naturfaser und 30% Kunstharz  
oval, 70% natural fibre and 30% synthetic resin  
oval, 70% fibra natural y 30% resina sintética  
ovale, 70% de fibres naturelles et 30% de résine synthétique

	cm	↑ cm	Farbe / Colour
30444	30 x 20	18	■
30447	30 x 20	18	■





rund

**Brottasche**  
bread basket  
panera  
corbeille



rund, schmutzabweisende Kunstfaser, 30°C waschbar, wendbar  
round, dirt-repellent synthetic fibre, washable 30°C, reversible  
redondo, fibra sintética repelente a la suciedad, lavable a 30°C, reversible  
ronde, fibre synthétique anti-salissante, lavable à 30°C, réversible

	Ø cm	↑ cm	Farbe / Colour
30345	17	11,5	■ ■
30346	20	13,5	■ ■



rechteckig

**Brottasche**  
bread basket  
panera  
corbeille



rechteckig, schmutzabweisende Kunstfaser, 30°C waschbar, wendbar  
rectangular, dirt-repellent synthetic fibre, washable 30°C, reversible  
rectangular, fibra sintética repelente a la suciedad, lavable a 30°C, reversible  
rectangulaire, fibre synthétique anti-salissante, lavable à 30°C, réversible

	cm	↑ cm	Farbe / Colour
30347	19 x 11	10,5	■ ■
30348	24 x 16	10,5	■ ■



Präsentationsmöglichkeit  
presentation example



rund

oval

**Brottasche**  
bread basket  
panera  
corbeille à pain en toile



Baumwolle, umgekrempelt kann die Höhe individuell gestaltet werden, maschinenwaschbar bis 30°C  
cotton, adjustable height by turning the edge upside down, machine-washable 30°C  
walgodón, altura ajustable girando el borde al revés, lavable a máquina 30°C  
coton, hauteur ajustable en tournant le bord à l'envers, lavable en machine maxi 30°C

	Ø cm	↑ cm	Farbe / Colour
30340	17	11	■ ■
30350	20	12	■ ■
30341	17	11	■ ■
30351	20	12	■ ■

	cm	↑ cm	Farbe / Colour
30360	20 x 15	10	■ ■
30370	25 x 18	12	■ ■
30361	20 x 15	10	■ ■
30371	25 x 18	12	■ ■

## BREAD BASKETS



### Brottasche mit Wärmekissen

bread basket with stones pillow  
panera con cojín  
corbeille à pain en toile avec coussin chauffant



**Baumwolle, Keramik-Kugeln, maschinenwaschbar bis 30°C, mit Zugverschluss, Wärmekissen kann einfach in der Mikrowelle erhitzt werden (90 Sekunden / 500 Watt)**

cotton, ceramic balls, machine washable up to 30°C, with drawstring closure, heat pad can easily be heated in the microwave (90 seconds / 500 watts)  
algodón, bolas de cerámica, lavable a máquina hasta 30°C, con cierre de cordón, la almohadilla térmica se puede calentar fácilmente en el microondas (90 segundos / 500 vatios)  
coton, billes en céramique, lavable en machine jusqu'à 30°C, avec fermeture à tirette, le coussin chauffant peut être facilement chauffé au micro-ondes (90 secondes / 500 watts)

	Ø cm	↑ cm	Farbe / Colour
30380	19	23	Yellow
30390	19	23	Yellow / Brown

**Wärmekissen / stones pillow / cojín de piedrecillas a calentar / coussin de petites pierres, à chauffer**

	Ø cm	↑ cm
30385	19	1,5



### Häkelkorb

crochet rope basket  
cesta de ganchillo  
panier au crochet



**umgekrepelt kann die Höhe individuell eingestellt werden**

adjustable height by turning the edge upside down

altura ajustable girando el borde al revés

hauteur ajustable en tournant le bord à l'envers

	cm	↑ cm
30395	20 x 13,5	10
30396	24 x 17,5	12



**Präsentationsmöglichkeit**  
presentation example



### Lunchbag, 2er Set

lunch bag, 2 pcs.  
bolsa de almuerzo, set de 2  
sac à lunch, set de 2



**70% Naturfaser und 30% Kunstharz, mit Klettverschluss**

70% natural fibre and 30% synthetic resin, with velcro fastener

70% fibra natural y 30% resina sintética, con cierre de velcro

70% de fibres naturelles et 30% de résine synthétique, avec fermeture velcro

	cm	↑ cm	pcs.
30357	16 x 10	32	2
30358	25 x 15	30	2



**Präsentationsmöglichkeit**  
presentation example



40690 0,7 ltr.



40691 0,7 ltr.



40692 0,7 ltr.



40693 1,4 ltr.



40694 1,4 ltr.



40695 1,4 ltr.

Schale  
bowl  
cuenco  
bol

gehämmerte Oberfläche  
hammered surface  
superficie martillada  
surface martelée



	Ø cm	↑ cm	ltr.	Farbe / Colour	
40690	15,5 x 12,0	5,5	0,7		gold look
40691	15,5 x 12,0	5,5	0,7		copper look
40692	15,5 x 12,0	5,5	0,7		gunmetal-look
40693	23,0 x 15,5	6,0	1,4		gold look
40694	23,0 x 15,5	6,0	1,4		copper look
40695	23,0 x 15,5	6,0	1,4		gunmetal-look



Präsentationsmöglichkeit  
presentation example



40604

Servierkorb „BURGER & FRIES“

serving basket  
cesta para servir  
corbeille de service

Servierkorb aus Metall mit 2 Haltern für Dipschälchen

metal serving basket with 2 holders for dip bowls

cesta de metal para servir con 2 soportes para cuencos para dip

corbeille de service en métal avec 2 supports pour ramequins



	cm	↑ cm
40604	39,5 x 20	11

passende Schälchen / suitable bowls / cuencos adecuados / bols  
appropriés



	Ø cm	↑ cm	ltr.	VE / unit
83781	7,5	4	0,07	24



83781

83781

Servierbeispiel - Lieferung ohne Schälchen  
delivery without bowls



Präsentationsmöglichkeit  
presentation example

# URBAN



## GN Korb „URBAN“

GN basket  
GN cesta  
GN corbeille



	cm	↑ cm	GN	Farbe / Colour
30414	53,0 x 32,5	7,5	1/1	■
30415	32,5 x 26,5	7,5	1/2	■
30416	53,0 x 16,2	7,5	2/4	■

## GN Abdeckhaube

GN cover  
GN cubierta  
GN cloche



	cm	↑ cm	GN	
11044	53 x 16,2	10,5	2/4	ohne Abbildung
11042	53 x 32,5	9,5	1/1	ohne Abbildung
11022	33 x 28,0	17,0	1/2	ohne Abbildung
11027	54 x 33,0	20,0	1/1	



## Korb „URBAN“

basket  
cesta  
corbeille



	cm	↑ cm	Farbe / Colour
30337	29 x 16	7	■



## Korb „URBAN“

basket  
cesta  
corbeille



	Ø cm	↑ cm	Farbe / Colour
30410	17	7,0	■
30411	20	8,5	■



## Korb „URBAN“

basket  
cesta  
corbeille



	cm	↑ cm	Farbe / Colour
30412	21 x 10	7	■
30413	30 x 14	12	■

# SVART



NEW



Korb „SVART“  
basket  
cesta  
corbeille

Black  
&  
beautiful

METALL



	cm	↑ cm	Farbe / Colour
30424	29,5 x 25,5	13,5	■



Präsentationsmöglichkeit  
presentation example



30422



30423

Korb „SVART“  
basket  
cesta  
corbeille

Black  
&  
beautiful

METALL



	cm	↑ cm	Farbe / Colour
30422	20 x 15	8	■
30423	24 x 19	8	■



30420



30421

Korb „SVART“  
basket  
cesta  
corbeille

Black  
&  
beautiful

METALL



	Ø cm	↑ cm	Farbe / Colour
30420	17,5	8	■
30421	20,0	8	■

# STAINLESS STEEL BASKETS

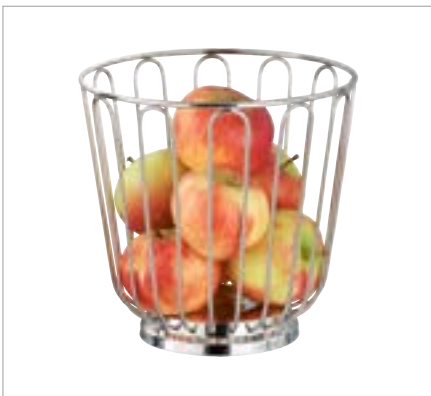

## Obstkorb

basket for fruits  
cesta para fruta  
corbeille à fruits

hochglanzpoliert  
mirror polished finish  
acabado pulido brillante  
brillant



	Ø cm	↑ cm
30270	21,5	20,5



## Brot- und Obstkorb

basket for bread or fruits  
cesta para pan o fruta  
corbeille à pain ou à fruits

hochglanzpoliert, rund  
mirror polished finish, round  
acabado pulido brillante, redondo  
brillant, rond



	Ø cm	↑ cm
30200	17,5	7,0
30220	20,5	8,5
30230	25,5	9,5

oval / oval / oval / oval

	cm	↑ cm
30210	20 x 15	7,0
30240	24 x 19	8,5
30250	28 x 21	9,5



## Brot- und Obstkorb

basket for bread or fruits  
cesta para pan o fruta  
corbeille à pain ou fruits



	Ø cm	↑ cm
30310	18	7,5



**Brot- und Obstkorb „WIRE“**  
 wire basket  
 cesta para pan o fruta  
 corbeille pour pain ou fruits



	Ø cm	↑ cm	Farbe / Colour	
30206	31	14		metal black



Präsentationsmöglichkeit  
 presentation example

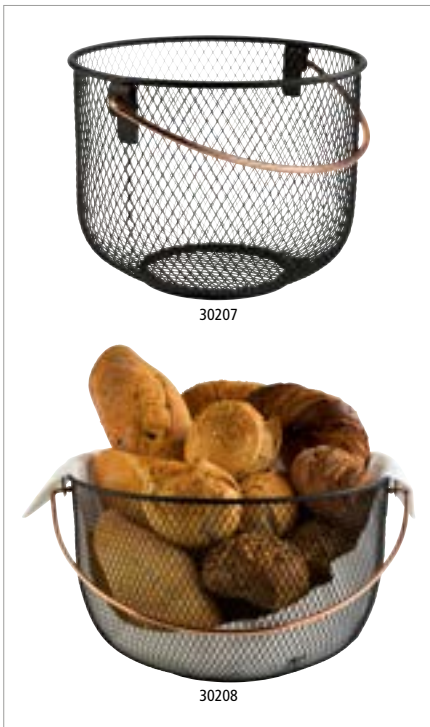

30207

30208

**Brot- und Obstkorb**  
 basket for bread or fruits  
 cesta para pan o fruta  
 corbeille à pain ou fruits



	Ø cm	↑ cm	Farbe / Colour	
30207	21	16,5		copper-look handle
30208	30	19,0		copper-look handle



Präsentationsmöglichkeit  
 presentation example



40190 **0,45 ltr.**

**Schale**  
 bowl  
 cuenco  
 bol



gehämmerte Oberfläche / hammered surface / superficie martillada / surface martelée

	cm	↑ cm	ltr.
40189	20 x 13,5	5,5	0,30
40190	24 x 16,5	7,0	0,45



30276

**Brot- und Obstschale**  
 bowl for bread or fruits  
 bol para pan o fruta  
 bol à pain ou à fruits



hochglanzpoliert, Hammerschlag Optik  
 mirror polished finish, hammered look  
 acabado pulido efecto espejo, aspecto repujado  
 brillant, aspect martelé

	Ø cm	↑ cm
30276	16	5,0
30277	20	5,5



# BASKETS / RISERS



## Korb / Ständer „APS PLUS“

basket / riser  
cesta / soporte  
corbeille / support



	Ø cm	↑ cm	Farbe / Colour
15320	10,5 / 8	8	polished chrome
15324	10,5 / 8	8	brushed gold
15322	10,5 / 8	8	brushed copper



## Korb / Ständer „APS PLUS“

basket / riser  
cesta / soporte  
corbeille / support



	Ø cm	↑ cm	Farbe / Colour
15331	15	10,5	polished chrome
15332	21	20,0	polished chrome
15334	15	10,5	brushed gold
15335	21	20,0	brushed gold



## Korb / Ständer „APS PLUS“

basket / riser  
cesta / soporte  
corbeille / support



	Ø cm	↑ cm	Farbe / Colour
15326	21 / 15	21	black



## LUNCHBOXES



## Lunchbox „M“

lunchbox  
fiambrella  
boîte à lunch



**Edelstahlbox mit Silikondichtung inkl. Trennsteg, auslaufsicher**

stainless steel box with silicone seal incl. divider, leak-proof

caja de acero inoxidable con junta de silicona y divisor extraíble, transporte sin salpicaduras

boîte en acier inox avec joint en silicone et diviseur amovible, transport sans éclaboussures

	cm	↑ cm	ltr.
66900	18,5 x 13,5	6,5	0,8



## Lunchbox „L“

lunchbox  
fiambrella  
boîte à lunch



**Edelstahlbox mit Silikondichtung inkl. Trennsteg, auslaufsicher**

stainless steel box with silicone seal incl. divider, leak-proof

caja de acero inoxidable con junta de silicona y divisor extraíble, transporte sin salpicaduras

boîte en acier inox avec joint en silicone et diviseur amovible, transport sans éclaboussures

	cm	↑ cm	ltr
66901	20,5 x 14,5	6,5	1,1



## Lunchbox „XL“

lunchbox  
fiambrella  
boîte à lunch



**Edelstahlbox mit Silikondichtung inkl. Trennsteg, auslaufsicher**

stainless steel box with silicone seal incl. divider, leak-proof

caja de acero inoxidable con junta de silicona y divisor extraíble, transporte sin salpicaduras

boîte en acier inox avec joint en silicone et diviseur amovible, transport sans éclaboussures

	cm	↑ cm	ltr
66902	22,5 x 16,5	6,5	1,4



mit zwei Verschlüssen  
with 2 clasps

66900

0,8 ltr.



66901

1,1 ltr.



66902

1,4 ltr.

herausnehmbarer Trennsteg  
removable divider



auslaufsicher | leak-proof





# SUPERBOX

11621  
Box GN 1/2

00973  
Schieferplatte  
GN 2/4

11620  
Box GN 1/1

Die stapelbaren Wendeböden lassen sich rutschfest stapeln und mit flachen GN Platten verbinden und einzeln nutzen. Individuell können Buffet-landschaften gebaut werden.

The stackable and non-slip reversible boxes can be connected to flat GN trays and can also be used individually. Different and individual buffet sceneries can be built up.

Las cajas girables y apilables son antideslizantes y se pueden conectar con bandejas planas GN o utilizar individualmente. Se pueden construir diferentes paisajes de buffet muy individuales.

Les boîtes de tournage empilables sont antiglissantes et peuvent être connectées avec des plateaux plats GN ou utilisées individuellement. Des paysages de buffet très personnalisés peuvent être construits.



## GN 1/1 „SUPERBOX“



Akazienholz / acacia wood / madera de acacia / bois d'acacia

	cm	↑ cm	GN	Farbe / Colour
11620	55,5 x 35,0	10,5	1/1	■
11626	55,5 x 35,0	10,5	1/1	■
11721	55,5 x 35,0	20,0	1/1	■
11723	55,5 x 35,0	20,0	1/1	■



## GN 2/4 „SUPERBOX“



Akazienholz / acacia wood / madera de acacia / bois d'acacia

	cm	↑ cm	GN	Farbe / Colour
11623	55,5 x 18,5	10,5		■
11629	55,5 x 18,5	10,5		■



## GN 1/2 „SUPERBOX“



Akazienholz / acacia wood / madera de acacia / bois d'acacia

	cm	↑ cm	GN	Farbe / Colour
11621	35,0 x 29,0	10,5	1/2	■
11627	35,0 x 29,0	10,5	1/2	■
11722	35,0 x 29,0	20,0	1/2	■
11724	35,0 x 29,0	20,0	1/2	■



GN 1/4 „SUPERBOX“

Akazienholz / acacia wood / mader de acacia / bois d'acacia



	cm	↑ cm	Farbe / Colour
11622	29 x 18,5	10,5	
11628	29 x 18,5	10,5	



GN „SUPERBOX VINTAGE“

Akazienholz  
acacia wood  
mader de acacia  
bois d'acacia

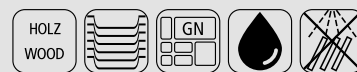

	cm	↑ cm	GN	Farbe / Colour
11715	55,5 x 35,0	10,5	1/1	
11716	35,0 x 29,0	10,5	1/2	
11717	29,0 x 18,5	10,5	1/4	
11718	55,0 x 18,5	10,5	2/4	



Präsentationsmöglichkeiten  
presentation examples



Buffetgestell

buffet stand  
soporte para buffet  
présentoir buffet



Metall, schwarz, passend für GN Boxen, mit Antrutschfüßchen  
metal, black, suitable for GN boxes, with non-slip feet  
metal, negro, para cajas GN, con pies antideslizantes  
métal, noir, pour boîtes GN, avec pieds antidérapantsw

	cm	↑ cm	suitable for
30331	49 x 38,5	48	GN 1/1, GN1/2 boxes



Präsentationsmöglichkeit  
presentation example





# Chafing Dish, GN Container & Transport

PREMIUM .....	334
GLOBE .....	336
EASY INDUCTION .....	339
INDUCTION STATION .....	341
CHAFING DISHES .....	342
FONDUE AND FIRE PUNCH BOWL SET .....	347
CHAFING DISHES   ACCESSORIES .....	348
INDUCTION PLATES   HEATING UNITS .....	349
HEATING UNITS   WARMERS .....	350
GRANITE CHIPS   CUTLERY RESTS .....	351
GN-CONTAINERS .....	352
SERVING TROLLEYS .....	364
CUTLERY BOXES .....	366
CONTAINERS   EGG BOXES .....	368
BUCKETS   FUNNELS .....	369

# PREMIUM



**langlebige Deckelbremse**  
Abnehmbarer Deckel, dieser lässt sich spielend leicht öffnen und schließen, der Lauf des Deckels wird professionell gedämpft.



**Kondenswasser - Rücklaufsystem**  
Kondenswasser wird in das Wasserbecken zurückgeführt.



**Sandwichboden / Kapselboden**  
Induktionsfähiger Boden, direkt auf dem Induktionskochfeld einsetzbar. Perfekte Wärmeverteilung und Steuerung.



**Fixierschraube / Rutschsicherung**  
Höhenverstellbares Gelenk, fixiert das Gerät in dem Gestell und auf dem Tisch.



**Induktionskochplatte Nr. 12295**  
Induktionskochplatte wird einfach in das Gestell gelegt.



**stapelbar**  
Chafing Dish Rahmen sind übereinander stapelbar. Platzsparend und rutschfest stapeln und transportieren.



## Induktionskochplatte für Chafing Dish

induction plate for chafing dish  
placa de inducción para chafing dish  
plaque à induction pour chafing dish

mit Regler  
with power control  
con control de potencia  
avec régulateur

	Ø cm	
12295	24	900 W



12370

**Lieferung ohne Induktionskochplatte**  
delivery without induction plate  
se entrega sin placa de inducción  
livré sans plaque à induction

GN 1/1 Chafing Dish „PREMIUM“



1 Gestell + 1 Wasserbecken mit Sandwichboden + 1 Wasserbeckenrahmen + 1 Deckel mit hydraulischem Gelenk + 1 GN 1/1 Behälter 65 mm tief, hitzebeständige Griffe, hochwertige Verarbeitung, ausschließlich für Induktionskochfelder

1 frame + 1 waterpan with sandwich base + 1 frame for waterpan + 1 hydraulic cover + 1 GN 1/1 container 65 mm, heat resistant handles, high quality, only for induction plates

1 soporte + 1 cubeta baño maría con base sandwich + 1 marco para cubeta baño maría + 1 tapa hidráulica + 1 cubeta GN 1/1 de 65 mm, asas resistentes al calor, acabado de alta calidad, solamente para inducción

1 pied support + 1 bac bain-marie avec fond sandwich + 1 cadre pour bac bain-marie + 1 couvercle hydraulique + 1 bac GN 1/1 de 65 mm, poignées résistantes à la chaleur, finition de qualité, uniquement pour induction

	cm	↑ cm	ltr.	
12370	66 x 48	33	9	mit Edelstahldeckel with stainless steel cover
12352	66 x 48	33	9	mit Glasdeckel with glass cover



12353

**Lieferung ohne Induktionskochplatte**  
delivery without induction plate  
se entrega sin placa de inducción  
livré sans plaque à induction

Chafing Dish rund „PREMIUM“



1 Gestell + 1 Wasserbecken mit Sandwichboden + 1 Wasserbeckenrahmen + 1 Deckel mit hydraulischem Gelenk + 1 runder Speisenbehälter, hitzebeständiger Griff, hochwertige Verarbeitung, für Induktionskochfelder geeignet

1 frame + 1 waterpan with sandwich base + 1 frame for waterpan + 1 hydraulic cover + 1 round foodpan, heat resistant handle, high quality, suitable for induction plates

1 soporte + 1 cubeta baño maría con base sandwich + 1 marco para cubeta baño maría + 1 tapa hidráulica + 1 cubeta redonda, asa resistente al calor, acabado de alta calidad, apto para inducción

1 pied support + 1 bac bain-marie avec fond sandwich + 1 cadre pour bac bain-marie + 1 couvercle hydraulique + 1 bac rond, poignée résistante à la chaleur, finition de qualité, apte pour induction

	cm	↑ cm	ltr.	
12371	44 x 54	33	6	mit Edelstahldeckel with stainless cover
12353	44 x 54	33	6	mit Glasdeckel with glass cover

Speiseneinsatz / foodpan / cubeta / bac supérieur

12366



12372

**Lieferung ohne Induktionskochplatte**  
delivery without induction plate  
se entrega sin placa de inducción  
livré sans plaque à induction

Chafing Dish rund „PREMIUM“



1 Gestell + 1 Wasserbecken mit Sandwichboden + 1 Wasserbeckenrahmen + 1 Deckel mit hydraulischem Gelenk + 1 runder Speisenbehälter, hitzebeständige Griffe, hochwertige Verarbeitung, für Induktionskochfelder geeignet

1 frame + 1 waterpan with sandwich base + 1 frame for waterpan + 1 hydraulic cover + 1 round foodpan, heat resistant handles, high quality, suitable for induction plates

1 soporte + 1 cubeta baño maría con base sandwich + 1 marco para cubeta baño maría + 1 tapa hidráulica + 1 cubeta redonda, asas resistentes al calor, acabado de alta calidad, apto para inducción

1 pied support + 1 bac bain-marie avec fond sandwich + 1 cadre pour bac bain-marie + 1 couvercle hydraulique + 1 bac rond, poignées résistantes à la chaleur, finition de qualité, apte pour induction

	cm	↑ cm	ltr.	
12372	44 x 48	39	10	mit Edelstahldeckel with stainless cover
12354	44 x 48	39	10	mit Glasdeckel with glass cover

Speisenbehälter / foodpan / cubeta superior / bac supérieur

12397

# GLOBE



die Deckelbremse sorgt für langsames Schließen

the revolving cover closes gently, thanks to a special built-in axle

sistema de freno para un cierre suave de la tapa

système avec frein pour une fermeture en douceur du couvercle



abnehmbarer Glas-Deckel mit Wasserrücklaufsystem

removable glass lid, with water-runback-system

tapa transparente desmontable con sistema de retorno de la condensación

couvercle transparent amovible avec système de retour de la condensation



Kondenswasser wird in das Wasserbecken zurückgeführt

condensed water is led back into the waterpan

el agua de condensación vuelve a la cubeta de agua

l'eau de condensation retourne dans le bac d'eau



für alle Herdarten geeignet, auch für Induktionskochplatten

suitable for all kinds of ovens, even induction cookers

apto para todas las fuentes de calor, incluso inducción

apte pour toutes les sources de chaleur, y compris induction



## GN 1/1 Chafing Dish „GLOBE“



hochglanzpoliert, mit abnehmbarem hydraulischem Edelstahl-Deckel, Sandwichboden sorgt für optimale Wärmeleitung, für Induktionsplatten geeignet, Set: Gestell + Wasserbecken + Speisenbehälter GN 1/1 65 mm tief, 9 Liter + Löffelablage + 2 Brennpastenbehälter + Metallrahmen für Induktionskochplatte

mirror polished finish, removable stainless steel hydraulic cover, sandwich base for optimum heat distribution, suitable for induction plates

set: frame + waterpan + GN 1/1 container 65 mm, 9l + cutlery compartment ladles + 2 burner holder + frame for induction plate

pulido brillante, tapa hidráulica de acero inoxidable extraíble, fondo difusor sandwich apto para inducción, incluye: soporte + cubeta baño maría + cubeta GN 1/1 de 65 mm, 9 l + soporte para cuchara (sin cuchara) + 2 quemadores + marco para la placa de inducción

poli brillant, couvercle inox hydraulique amovible, fond diffuseur sandwich apte pour induction, comprend: pied support + bac bain-marie + bac GN 1/1 de 65 mm, 9 l + porte-louche (louche non incluse) + 2 brûleurs + cadre inox pour la plaque à induction

	cm	↑ cm	ltr.	
12394	66,5 x 44	34	9	mit Edelstahldeckel with stainless cover
12404	66,5 x 44	34	9	mit Glasdeckel with glass cover

Induktionskochplatte für Chafing Dish / induction plate for chafing dish / placa de inducción para chafing dish / plaque à induction pour chafing dish

12295

Metallrahmen für Induktionskochplatte / frame for induction plate / estructura o marco para placa de inducción / cadre support inox pour plaque induction

12296





**Suppen-Kugel inkl. Gestell „GLOBE“**

soup bowl with stand  
cubeta sopa con soporte  
récipient à soupe avec pied

hochglanzpoliert, inkl. Speisenbehälter, 1 Brennpastenbehälter, mit einhängbarer Löffelablage, Sandwichboden sorgt für optimale Wärmeverteilung, für Induktionsplatten geeignet, einfaches Anbringen und Entfernen des Deckels, hitzeisolierende Griffe, 1 Metallrahmen für Induktionskochplatten

mirror polished finish, incl. foodpan and 1 burner holder, with fitting compartment for ladles, sandwich bottom for optimum heat distribution, gentle opening of the lid, heat-resistant handles, frame for induction plate

acabado pulido brillante, cubeta sopa inox, 1 quemador, platillo a colgar para el cucharón, fondo difusor sandwich, apto para inducción, tapa con apertura controlada, asas frías, marco para placa de inducción

poli brillant, récipient à soupe inox, 1 brûleur, repose-couvert à accrocher, fond diffuseur sandwich, apte pour induction, couvercle à ouverture contrôlée, anses froides, cadre support inox pour plaque à induction



	Ø cm	↑ cm	ltr.
12398	48	45	10

**Induktionskochplatte für Chafing Dish / induction plate for chafing dish / placa de inducción para chafing dish / plaque à induction pour chafing dish**

12295

**Metallrahmen für Induktionskochplatten / frame for induction plate / marco para placa de inducción / cadre support inox pour plaque induction**

12291

**Suppen-Kugel „GLOBE“**

soup bowl  
cubeta sopa  
récipient à soupe

hochglanzpoliert, inkl. Speisenbehälter, mit einhängbarer Löffelablage, Sandwichboden sorgt für optimale Wärmeverteilung, für Induktionsplatten geeignet, einfaches Anbringen und Entfernen des Deckels, hitzeisolierende Griffe (Lieferung ohne Gestell, Löffel)

mirror polished finish, incl. foodpan, with fitting compartment for ladles, sandwich bottom for optimum heat distribution, gentle opening of the lid, heat-resistant handles (delivery without rack, ladle)

acabado pulido brillante, cubeta sopa inox, platillo a colgar para el cucharón, fondo difusor sandwich, apto para inducción, tapa con apertura controlada, asas frías (cucharón no incluido)

poli brillant, récipient à soupe inox, repose-couvert à accrocher, fond diffuseur sandwich, apte pour induction, couvercle à ouverture contrôlée, anses froides (cadre, louche non incluse)



	Ø cm	↑ cm	ltr.
12399	48	32	10

**Gestell inkl. Brenner / frame incl. burner / soporte incluyendo quemador / support, brûleur inclus**

12396

**Speisenbehälter / foodpan / cubeta superior / bac supérieur**

12397





### Chafing Dish „GLOBE“



hochglanzpoliert, mit abnehmbarem hydraulischen Edelstahl-Deckel, Sandwichboden sorgt für optimale Wärmeleitung, für Induktionsplatten geeignet

Set: Gestell + Wasserbecken + Speisenbehälter rund + Löffelablage + Brennpastenbehälter + Metallrahmen für Induktionskochplatte

mirror polished finish, removable hydraulic cover, sandwich base, optimum heat distribution set: frame + waterpan + foodpan round + cutlery compartment ladles + burner holder + frame for induction plate

pulido brillante, con tapa hidráulica extraíble, fondo difusor sandwich apto para inducción. Incluye: 1 pie, 1 cubeta baño maria, 1 cubeta redonda, 1 soporte para cuchara (sin cuchara), 1 quemador, marco inox para la placa de inducción

brillant, couvercle hydraulique amovible, fond diffuseur sandwich apte pour induction.

Comprend: pied, cuve bain-marie, bac inox rond, porte-louche (louche non incluse), 1 brûleur, cadre inox pour la plaque à induction

	Ø cm	↑ cm	ltr.	
12393	38,5	34	6	mit Edelstahldeckel with stainless cover
12403	38,5	34	6	mit Glasdeckel with glass cover

Induktionskochplatte für Chafing Dish / induction plate for chafing dish / placa de inducción para chafing dish / plaque à induction pour chafing dish

12295

Metallrahmen für Induktionskochplatten / frame for induction plate / marco para placa de inducción / cadre support inox pour plaque induction

12291

Speiseneinsatz / foodpan / cubeta / bac supérieur

12366

Porzellan-Einsatz / porcelain insert / bandeja de porcelana / bac supérieur en porcelaine

	Ø cm	↑ cm	ltr.	fits to
82210	39	6	4,3	12393, 12403
82215	39	6	4,0	12393, 12403



### GN 2/3 Chafing Dish „GLOBE“

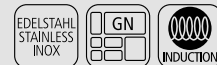

hochglanzpoliert, mit abnehmbarem hydraulischem Edelstahl-Deckel, Sandwichboden sorgt für optimale Wärmeleitung, für Induktionsplatten geeignet, Set: Gestell + Wasserbecken + 1 GN 2/3 Behälter 65 mm tief + Löffelablage + 1 Brennpastenbehälter + 1 Metallrahmen für Induktionskochplatte

mirror polished finish, removable hydraulic cover, sandwich base, optimum heat distribution, set: frame + waterpan + foodpan GN 2/3, 65 mm, 5,5 l + compartment for ladles + burner holder + frame for induction plate

pulido brillante, con tapa hidráulica extraíble, fondo difusor sandwich apto para inducción. Incluye: 1 pie, 1 cubeta baño maria, 1 cubeta GN 2/3 65 mm - 5,5 l, 1 soporte para cuchara (sin cuchara), 1 quemador, marco inox para la placa de inducción

poli brillant, couvercle hydraulique amovible, fond diffuseur sandwich apte pour induction.

Comprend: pied, cuve bain-marie, bac inox GN 2/3-65 mm - 5,5 L, porte-louche (louche non incluse), brûleur, cadre inox pour la plaque à induction

	cm	↑ cm	ltr.	
12483	44 x 41	34	5,5	mit Edelstahl-Deckel with stainless steel cover
12484	44 x 41	34	5,5	mit Glasdeckel with glass cover

## EASY INDUCTION



die Deckelbremse sorgt für langsames Schließen

the revolving cover closes gently, thanks to a special built-in axle

sistema de freno para un cierre suave de la tapa

système avec frein pour une fermeture en douceur du couvercle



Druckhebel zum leichten Entnehmen des GN-Behälters

stick for easy removing of the GN-container

dispositivo para levantar y quitar con facilidad la cubeta GN

dispositif pour lever et retirer facilement le bac GN



abnehmbarer Glas-Deckel mit Wasserrücklaufsystem

removable glas lid, with water-runback-system

tapa transparente desmontable con sistema de retorno de la condensación

couvercle transparent amovible avec système de retour de la condensation



Fixierschraube verhindert das Rutschen

fixing screw for skid resistance

Pie trasero anti-deslizante, altura regulable

Pied supplémentaire anti-dérapant réglable en hauteur



Lieferung ohne Induktionskochplatte  
delivery without induction plate  
se entrega sin placa de inducción  
livré sans plaque à induction

## GN 1/1 Chafing Dish „EASY INDUCTION“



1 Gestell + 1 Wasserbecken mit Sandwichboden + 1 Deckel mit hydraulischem Gelenk + 1 GN 1/1 Behälter 65 mm tief, hitzebeständige Griffe, hochwertige Verarbeitung, ausschließlich für Induktionskochfelder

1 frame + 1 waterpan with sandwich base + 1 hydraulic cover + 1 GN 1/1 container 65 mm, heat-resistant handles, high quality, only for induction plates

1 marco + 1 baño maría con base sandwich + 1 marco con tapa hidráulica + 1 cubeta GN 1/1 pan 65 mm profundo, asas resistentes al calor, buenos acabados, solamente para inducción

1 pied support + 1 bac bain-marie avec fond sandwich + 1 cadre avec couvercle hydraulique + 1 bac GN 1/1 - 65mm, poignées résistantes à la chaleur, belle qualité, uniquement pour induction

	cm	↑ cm	GN	ltr.
12322	60 x 42	30	1/1	9



Lieferung ohne Induktionskochplatte  
delivery without induction plate  
se entrega sin placa de inducción  
livré sans plaque à induction

## GN 2/3 Chafing Dish „EASY INDUCTION“



1 Gestell + 1 Wasserbecken mit Sandwichboden + 1 Wasserbeckenrahmen + 1 Deckel mit hydraulischem Gelenk + 1 GN 2/3 Behälter 65 mm tief, hitzebeständige Griffe, hochwertige Verarbeitung, ausschließlich für Induktionskochfelder

1 frame + 1 waterpan with sandwich base + 1 frame for waterpan + 1 hydraulic cover + 1 GN 2/3 container 65 mm, heat-resistant handles, high quality, only for induction plates

1 marco + 1 baño maría con base sandwich + 1 marco con tapa hidráulica + 1 cubeta GN 2/3 pan 65 mm profundo, asas resistentes al calor, buenos acabados, solamente para inducción

1 pied support + 1 bac bain-marie avec fond sandwich + 1 cadre avec couvercle hydraulique + 1 bac GN 2/3 - 65mm, poignées résistantes à la chaleur, belle qualité, uniquement pour induction

	cm	↑ cm	GN	ltr.
12323	42 x 41	30	2/3	5,5



## EASY INDUCTION



Lieferung ohne Induktionskochplatte  
delivery without induction plate  
se entrega sin placa de inducción  
livré sans plaque à induction

### Chafing Dish „EASY INDUCTION“



1 Gestell + 1 Wasserbecken mit Sandwichboden + 1 Deckel mit hydraulischem Gelenk  
+ 1 runder Speisenbehälter, hitzebeständige Griffe, hochwertige Verarbeitung,  
ausschließlich für Induktionskochfelder geeignet

1 frame + 1 waterpan with sandwich base + 1 hydraulic cover + 1 round foodpan,  
heat-resistant handles, high quality, good for induction plates

1 soporte + 1 baño maría con base sandwich + 1 tapa hidráulica + 1 cubeta redonda,  
asas resistente al calor, buen acabado, apto para inducción

1 pied support + 1 bac bain-marie avec fond sandwich + 1 cadre avec couvercle hydraulique +  
1 bac rond, poignées résistante à la chaleur, belle qualité, uniquement pour induction

	cm	↑ cm	ltr.
12324	46 x 50	30	6



Lieferung ohne Induktionskochplatte  
delivery without induction plate  
se entrega sin placa de inducción  
livré sans plaque à induction

### Chafing Dish „EASY INDUCTION“



1 Gestell + 1 Wasserbecken mit Sandwichboden + 1 Deckel mit hydraulischem Gelenk +  
1 runder Speisenbehälter, hitzebeständige Griffe, hochwertige Verarbeitung,  
ausschließlich für Induktionskochfelder geeignet

1 frame + 1 waterpan with sandwich base + 1 hydraulic cover + 1 round foodpan,  
heat-resistant handles, high quality, good for induction plates

1 soporte + 1 baño maría con base sandwich + 1 tapa hidráulica + 1 cubeta redonda,  
asas resistente al calor, buen acabado, apto para inducción

1 pied support + 1 bac bain-marie avec fond sandwich + 1 cadre avec couvercle hydraulique +  
1 bac rond, poignées résistante à la chaleur, belle qualité, uniquement pour induction

	cm	↑ cm	ltr.
12325	48 x 42	39	11



### Induktionskochplatte für Chafing Dish

induction plate for chafing dish  
placa de inducción para chafing dish  
plaque à induction pour chafing dish

mit Regler

with power control

con control de potencia

avec régulateur

	Ø cm		
12295	24	900 W	



### Porzellan-Einsatz

porcelain insert  
bandeja de porcelana

bac supérieur en porcelaine



	Ø cm	↑ cm	ltr.	fits to
82210	39	6	4,3	12324, 12393, 12403
82215	39	6	4,0	12324, 12393, 12403



Die Induktionsstation mit Regler präsentiert sich in einem Set aus Walnussholz, einem schwarzen Metallständer und einer Induktionsheizung.

The induction station with controller is presented in a set of walnut wood, a black metal stand and an induction heater.

La estación de inducción con regulador se presenta en un set formado por una caja de madera de nogal, un soporte de metal negro y un calentador de inducción.

La station à induction avec température réglable se compose d'un caisson en bois noyer, d'un support métallique noir et d'une plaque à induction.



**Induktionsstation, 4-tlg. Set**  
induction station, 4 pcs.  
estación de inducción, set de 4  
station d'induction, set de 4



**4 teiliges Set:**

- 1 Induktionskochplatte mit Regler (Ø 24 cm, 900 Watt)
- 1 Metallständer schwarz
- 1 Rahmen aus Walnussholz geölt
- 1 Edelstahlrahmen

**4 pcs. set:**

- 1 induction hotplate with controller (Ø 24 cm, 900 Watt)
- 1 metal stand black
- 1 frame in oiled walnut wood
- 1 stainless steel frame

**set de 4:**

- 1 placa de inducción con regulador (Ø 24 cm, 900 vatios)
- 1 soporte de metal negro
- 1 caja de madera de nogal aceitada
- 1 marco de acero inoxidable

**set de 4:**

- 1 plaque d'induction avec température réglable (Ø 24 cm, 900 watts)
- 1 support métallique noir
- 1 caisson en bois noyer huilé
- 1 cadre en acier inox

	cm	↑ cm
12270	35,4 x 32,5	19

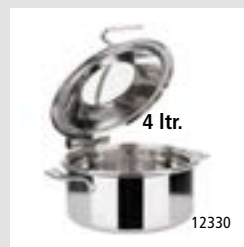

passendes Chafing Dish Set 12330  
sutable chafing dish set 12330

**Ersatzteile / replacement parts / piezas de repuesto / pièces de rechange**

	cm	↑ cm	
12271	35,4 x 32,5	8,5	Holzrahmen / wooden frame
12272	29,5 x 26,5	1	Edelstahlrahmen / stainless steel frame
12295	Ø 24	-	900 Watt Induktionskochplatte / induction plate
15506	35,4 x 32,5	17,6	Buffetständer schwarz / buffet stand black



**Chafing Dish, 4-teiliges Set**

chafing dish set, 4 pcs.  
chafing dish, set de 4  
chafing dish, set de 4



**4-teiliges Set:**

- 1 Topf (8 Liter)
- 1 Speisenbehälter (4 Liter)
- 1 Deckel mit Sichtfenster und 1 Deckelbremse,
- Topf mit induktionsfähigem Sandwich- / Kapselboden

**4 pcs. set:**

- 1 pot (8 litres),
- 1 foodpan (4 litres)
- 1 lid with glass insert and 1 automatic lid brake
- pot with induction-compatible sandwich base

**set de 4:**

- 1 olla (8 litros)
- 1 cubeta (4 litros)
- 1 tapa con ventanilla y 1 sistema de freno en la tapa
- olla con base sandwich apta para inducción

**set de 4:**

- 1 casserole (8 litres)
- 1 bac (4 litres)
- 1 couvercle avec fenêtre et 1 système de frein dans le couvercle
- casserole avec fond sandwich pour induction

	Ø cm	↑ cm	ltr.	Farbe / Colour	
12330	30,5	17,5	4		stainless
12335	30,5	17,5	4		copper
12336	30,5	17,5	4		yellow
12337	30,5	17,5	4		red
12338	30,5	17,5	4		black



**abnehmbarer Deckel**  
removable lid

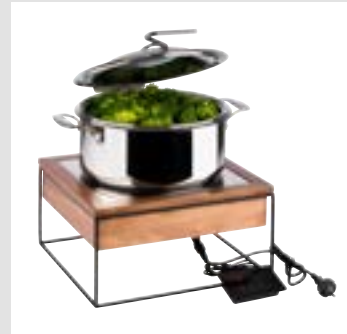

**induktionsgeeignet**  
suitable for induction

**Ersatz-Speisenbehälter zu Chafing Dish** / replacement foodpan for chafing dish / cubeta interior de repuesto para chafing dish / bac intérieur de remplacement pour le chafing dish

	Ø cm	↑ cm	ltr.	fits to
12329	30,5	8	4	12330, 12335, 12336, 12337, 12338



**8 ltr. Topf**  
8 ltr. pot



**Sandwich- / Kapsel-**  
boden / sandwich base



**4 ltr. Speisenbehälter**  
4 ltr. foodpan



**Deckelbremse**  
automatic lid break

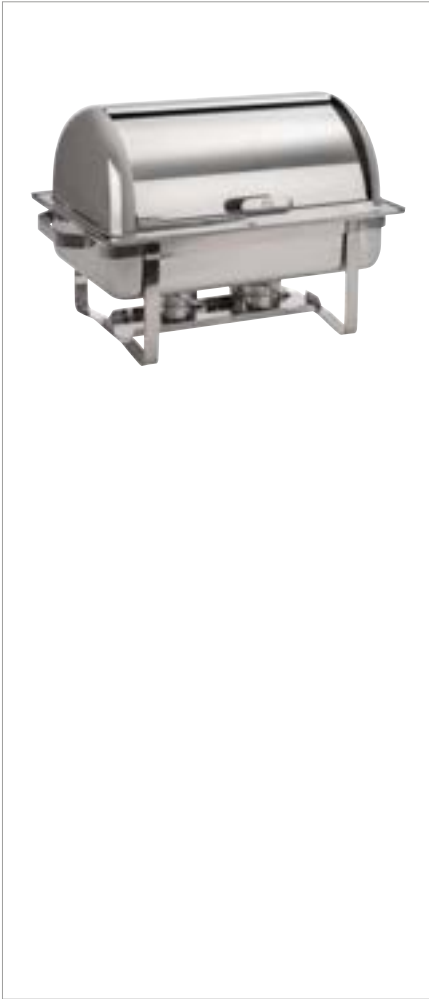

Rolltop-Chafing Dish „MAESTRO“



Speisenbehälter GN1/1 65 mm tief (passend auch für 100 mm) + Rolltopdeckel 90° + Wasserbecken inkl. Vorrichtung für Heizplatte + 2 Brennpastenbehälter  
 foodpan GN1/1 65 mm (also for 100 mm) + rolltop cover 90° + waterpan with screws for heating unit + 2 burner holders  
 cubeta GN 1/1 - 65 mm (hay espacio para una cubeta 100 mm) + campana rolltop abatible a 90° + 2 quemadores  
 bac GN 1/1 - 65 mm (accepte aussi bac ht. 100 mm) + couvercle rolltop ouverture 90° + 2 brûleurs

	cm	↑ cm	ltr.
12300	67 x 35	45	9



Rolltopdeckel 90°  
rolltop cover 90°



Präsentationsmöglichkeit  
presentation example



Rolltop-Chafing Dish „ELITE“



poliert, Rolltopdeckel klappbar auf 90° und 180°, Speisenbehälter GN 1/1 65 mm tief + Wasserbecken + 2 Brennpastenbehälter, wechseln des GN-Behälters ohne Abnehmen des Deckels (kein Kondenswasser-Rücklaufsystem)  
 polished, rolltop cover adjustable at 90° and 180°, foodpan GN 1/1 65 mm deep + waterpan + 2 burner holders, change of the GN container without removing the lid (condensed water can not be led back into the waterpan)  
 pulido brillante, tapa rolltop a 90° o 180°, cubeta GN 1/1 + 2 quemadores, cuba baño maría, se puede cambiar la cubeta GN sin retirar la tapa, importante: el agua condensada no revierte en los alimentos  
 poli brillant, couvercle rolltop ouverture de 90 a 180°, bac GN 1/1, bain-marie, 2 brûleurs, le bac GN peut être retiré et remplacé sans démonter le couvercle, important: la condensation ne retombe pas sur les aliments

	cm	↑ cm	ltr.
12350	67 x 47	45	9

Wasserbecken inkl. Vorrichtung für Heizelement / waterpan / baño maría / bain-marie

12249



inkl. Vorrichtung für Heizelement  
incl. screws for heating unit

## CHAFING DISHES



inkl. Vorrichtung  
für Heizelement  
incl. screws  
for heating unit

### Rolltop-Chafing Dish „CATERER“



Speisenbehälter GN 1/1 65 mm tief + Rolltopdeckel 90° + Wasserbecken inkl. Vorrichtung für Heizplatte + 2 Brennpastenbehälter (Lieferung ohne Heizplatte), massiver Ständer  
foodpan GN 1/1 65 mm deep + rolltop cover 90° + waterpan with screws for heatingunit + 2 burner holders (without heating unit), stable frame  
1 cubeta GN 1/1 - 65 mm + campana rolltop abatible a 90° + 2 quemadores + cuba baño maría con fijaciones para resistencia amovible (se sirve sin la resistencia)  
1 bac GN 1/1 - 65 mm + couvercle rolltop ouverture 90° + 2 brûleurs + 1 bac bain-marie avec 4 vis pour fixation résistance de chauffe amovible (non include)

	cm	↑ cm	ltr.
12245	67 x 35	45	9

Wasserbecken inkl. Vorrichtung für Heizelement / waterpan / baño maría / bain-marie

12249



### Chafing Dish „CATERER PRO“



Deckel hochglanzpoliert, Deckelgriffe hitzebeständig + 2 Brennpastenbehälter + Wasserbecken, inkl. Vorrichtung für Heizplatte + Gestell mit Deckelhalterung (ohne GN Speisenbehälter)  
cover mirror polished finish, cover knob heat-resistant + 2 burner holders + waterpan with screws for heating unit + frame with coverholder (without GN foodpan)  
tapa pulido brillante, asas frías + 2 quemadores + cuba inferior con tornillos para resistencia removible (no incluida) + tapa y estructura con sujeción de la tapa (se sirve sin la cubeta GN)  
couvercle poli brillant, anses froides + 2 brûleurs + bac bain-marie avec fixations pour résistance amovible (non include)

	cm	↑ cm
12233	64 x 35	34

Ersatzdeckel / replacement cover / tapa de recambio / couvercle de rechange

12236

Wasserbecken inkl. Vorrichtung für Heizelement / waterpan / baño maría / bain-marie

12249



### Chafing Dish „CHEF“



Speisenbehälter GN 1/1 65 mm tief + 2 Brennpastenbehälter + Wasserbecken + Deckel + Gestell mit Deckelhalterung + langer Hohlgriff  
foodpan GN 1/1 65 mm + 2 burner holders + waterpan + cove + frame with coverholder  
1 cubeta GN 1/1 65 mm + 2 quemadores + cubeta para el agua + tapa y chasis con bloqueo para la tapa  
1 bac GN 1/1 - 65 mm + 2 brûleurs + 1 bac bain-marie + couvercle + chasis avec blocage couvercle + poignée tube creux

	cm	↑ cm	ltr.
11675	61 x 31	30	9





GN 1/1 100 mm  
14 ltr.

**Elektro-Rolltop-Chafing Dish „ELITE“**

electric rolltop chafing dish  
chafing dish eléctrico rolltop  
chafing dish électrique rolltop



poliert, Rolltopdeckel klappbar auf 90° und 180°, Elektro-Wasserbecken mit Temperaturregelung + Speisenbehälter GN 1/1 100 mm tief, 220 - 240 V ~ 50 Hz; 760 - 900 W (kein Kondenswasser-Rücklaufsystem)

polished, rolltop cover adjustable at 90° and 180°, electric waterpan with adjustable heat control + foodpan GN 1/1 100 mm deep, voltage 220 - 240 V ~ 50 Hz, power consumption 760 - 900 W (condensed water cannot be led back into the waterpan)

pulido brillante, tapa abatible apertura a 90° o 180°, baño maría c/ termostato + cubeta GN 1/1 - 100 mm, 220-240 V-50 Hz. Consumo 760-900 W (el agua condensada no gotea dentro de la cubeta)

poli brillant, couvercle rolltop ouverture à 90° ou 180°, bain-marie électrique avec thermostat + bac GN 1/1-100 mm, 220-240 V - 50 Hz; 760-900 W (Important: la condensation ne retombe pas sur les aliments)

	cm	↑ cm	ltr.
12360	67 x 47	45	14



**Elektrischer Suppentopf „ECONOMIC“**

electric soup warmer  
marmita de sopa eléctrica  
marmite à soupe électrique



Stahl schwarz lackiert, herausnehmbarer Einsatz aus Edelstahl, mit Wasserbad, Temperaturregelung 30°C - 90°C, dreh- und klappbarer Edelstahl-Deckel, inkl. 8 magnetisch haftenden Beschriftungen, 400 W / 230 V

metal, black, removable soup pot, with bain marie, thermostat 30°C - 90°C, st. steel lid, incl. 8 magnetic signs, 400 W / 230 V

metal negro, recipiente sopa inox extraíble, con baño maria, termostato 30°C- 90°C, tapa inox, incluye 8 letreros magnéticos, 400 W / 230 V

acier, noir, récipient à soupe inox amovible, avec bain-marie, thermostat 30°C - 90°C, couvercle inox, 8 étiquettes magnétiques, 400 W / 230 V

	Ø cm	↑ cm	ltr.
11915	32	36	9

Speisenbehälter / foodpan / recipiente sopa / récipient à soupe

11916

Deckel / cover / tapa / couvercle

11917



**Elektro Chafing Dish**

electric chafing dish  
chafing dish eléctrico  
chafing dish électrique



Speisenbehälter GN 1/1 100 mm tief, Deckelhalter, Thermostat-Regelung 900 W, 230 V

foodpan GN 1/1 100 mm deep, lid holder, thermostat control 900 W, 230 V

cubeta GN 1/1-100 mm, sujeción de la tapa, termostato, 900W, 230 V

bac GN 1/1-100 mm, blocage du couvercle, thermostat, 900W, 230 V

	cm	↑ cm	ltr.
12225	63 x 36	29	14

Deckel / cover / tapa / couvercle

12235

## CHAFING DISHES



### Elektro-Chafing Dish „ECO“

electric chafing dish  
chafing dish eléctrico  
chafing dish électrique



Deckel poliert, Elektro-Wasserbecken mit Temperaturregelung + Speisenbehälter GN 1/1  
65 mm tief, 220 - 240 V ~ 50 Hz; 760 - 900 W

cover polished, electric waterpan with adjustable heatcontrol + foodpan GN 1/1 65 mm deep,  
voltage 220 - 240 V ~ 50 Hz, power consumption 760 - 900 W

tapa pulido brillante, baño maría c/ termostato + cubeta GN 1/1 - 65 mm - 220-240 V-50 Hz. /  
760-900 W

couvercle poli brillant, bain-marie électrique avec thermostat + bac GN 1/1-65 mm, 220-240  
V - 50 Hz; 760-900 W

	cm	↑ cm	ltr.
12232	63 x 36	29	9



### Elektrischer Suppentopf

electric soup warmer  
marmita de sopa eléctrica  
marmite à soupe électrique



herausnehmbarer Einsatz aus Edelstahl, elektrisch, mit Wasserbad + Löffel + integrierter  
Tragering für den Innenbehälter, Deckel mit hitzeisolierendem Griff, Temperaturregelung  
80°C (± 10°C), 450-550 W, 230 V

removable soup st. steel pan, bain marie electric, ladle, circular frame,  
thermostat control till 80°C (± 10°C), 450-550 W, 230 V

recipiente sopa inox extraíble, baño maría eléctrico + cucharón + aro inox, tapa con asas frías,  
termostato hasta 80°C precisión (± 10°C), 450-550 W, 230 V

réipient à soupe inox amovible, bain-marie électrique, louche, support circulaire inox, ther-  
mostat maxi 80°C (± 10°C), 450-550 W, 230 V

	Ø cm	↑ cm	ltr.
11901	38	36,5	10



### Elektrischer Suppentopf

electric soup warmer  
marmita de sopa eléctrica  
marmite à soupe électrique



herausnehmbarer Einsatz aus Edelstahl, elektrisch, mit Wasserbad + Löffel + integrierter  
Tragering für den Innenbehälter, Deckel mit hitzeisolierendem Griff, Temperaturregelung  
80°C (± 10°C), 400 - 450 W / 220 - 240 V

removable soup st. steel pan, bain marie electric, ladle, st. steel circular frame,  
thermostat control till 80°C (± 10°C), 400 - 450 W / 220 - 240 V

recipiente sopa inox extraíble, baño maría eléctrico + cucharón + aro inox,  
tapa con asas frías, termostato hasta 80°C precisión (±10°C) , 400 - 450 W / 220 - 240 V

réipient à soupe inox amovible, bain-marie électrique, louche, support circulaire inox, ther-  
mostat maxi 80°C (± 10°C), 400 - 450 W / 220 - 240 V

	Ø cm	↑ cm	ltr.
11910	40	37	10

# TWO IN ONE



## Fondue und Feuerzangenbowle-Set „TWO IN ONE“

fondue and fire punch bowl set  
set para fondue o ponche caliente  
service à fondue et à punch



13-teiliges Set aus Edelstahl bestehend aus:

1 Topf, 1 Rechaud, 1 Spritzschutz, 1 Untersetzer, 1 Schöpfkelle, 1 Feuerzange,  
1 Pastenbrenner, 6 Fonduegabeln

13-piece stainless steel set consisting of:

1 pot, 1 rechaud, 1 splash guard, 1 coaster, 1 ladle, 1 fire tongs,  
1 paste burner, 6 fondue forks

set de 13 piezas de acero inoxidable compuesto por:

1 olla, 1 rechaud, 1 protector contra salpicaduras, 1 trébede, 1 cazo,  
1 pinza para el fuego, 1 quemador de pasta, 6 tenedores de fondue

set de 13 pièces en acier inox comprenant:

1 marmite, 1 rechaud, 1 pare-éclaboussures, 1 dessous de plat, 1 louche, 1 pince à feu,  
1 brûleur à pâte, 6 fourchettes à fondue

	Ø cm	↑ cm	ltr.
65060	22	23	2,2

### Brennpastenbehälter zu 65060

fuel paste container for 65060  
recipiente para pasta de combustible para 65060  
récipient pour pâte à combustible pour 65060



	cm	↑ cm	fits to
65061	26 x 12	10	65060

### Gabelset zu 65060

fork set for 65060  
set de tenedores para 65060  
set de fourchettes pour 65060



	cm	→ cm	pcs.	fits to
65062	24	Griff / handle 8	6	65060



**Kaffeedispenser „HAPPY HOUR“**

coffee dispenser  
dispensador de café  
distributeur de café



hochglanzpoliert, für warme Getränke, stabil und standfest, inkl. 1 Brennpastenbehälter  
mirror polished finish, for warm drinks, solid and stable, incl. 1 burner holder  
acabado pulido brillante para bebidas calientes, sólido y estable, incluye un calentador  
brillant, pour boissons chaudes, avec 1 brûleur, robuste et stable

	cm	↑ cm	ltr.
11672	31 x 33,5	54,5	10,5

Hahn / tap / grifo / robinet

11671

Elektro-Heizelement / heating unit / resistencia / résistance

	cm	↑ cm
12287	21 x 20	6



**Rolltophaube „SWISS“**

rolltop-cover  
campana rolltop  
cloche rolltop



hochglanzpoliert, klappbar auf 90°, nachrüstbar für alle handelsüblichen Chafer  
mirror polished finish, cover adjustable at 90°, usable for all commercial chafing dishes  
pulido brillante, tapa ajustable 90°, apto para todos los chafings profesionales  
poli brillant, ouverture réglable à 90°, apte pour tous les chafings professionnels

	cm	↑ cm
12310	55 x 34	19,5



**Bain-Marie Topf**

bain marie pot  
olla baño Maria  
marmite bain-marie



inkl. Deckel, mit Löffelaussparung  
included cover, notched for spoon  
incluye tapa con hueco para la cuchara  
includ le couvercle avec espace pour la louche

	Ø cm	↑ cm	ltr.
12244	20	18	4,5

Deckel / cover / tapa / couvercle

11244



**Bain-Marie Deckel**

cover for bain marie  
tapa del baño maría  
couvercle du bain-marie



	cm
12243	54 x 33,5



**Einbau-Induktionskochplatte für Chafing Dish**

built-in induction plate for chafing dish  
placa de inducción para empotrar  
plaque à induction à encastrer

**inkl. Kabel-Fernbedienung, energiesparend, Leistung in 5 Stufen regelbar**

incl. cable remote control, energy-saving, power adjustable in 5 steps  
incl. mando a distancia con cable, ahorro energético, potencia regulable en 5 pasos  
y compris télécommande filaire, économe en énergie, puissance réglable en 5 étapes

	cm	↑ cm	
12285	35,5 x 35,5	6	2000 W



**Induktionskochplatte für Chafing Dish**

induction plate for chafing dish  
placa de inducción para chafing dish  
plaque à induction pour chafing dish

**inkl. Kabel-Fernbedienung, energiesparend, Leistung in 5 Stufen regelbar**

incl. cable remote control, energy-saving, power adjustable in 5 steps  
incl. mando a distancia con cable, ahorro energético, potencia regulable en 5 pasos  
y compris télécommande filaire, économe en énergie, puissance réglable en 5 étapes

	Ø cm		
12295	24		900 W



12291

**Metallrahmen für Induktionskochplatten**

frame for induction plate  
marco para placa de inducción  
cadre support inox pour plaque induction



12291	für runde Chafer / for round chafing dish
12296	für Chafer GN 1/1 / for GN 1/1 chafing dish



**Elektro-Heizelement**

heating unit  
resistencia  
résistance



**für Kaffeedispenser (Nr. 11672), 500 W, 220 V, einfach in das Gestell des Dispensers legen**  
for coffee dispenser (no. 11672), 500 W, 220 V, insert into the frame of the dispenser  
para dispensador de café (11672), 500 W, 220V, directamente en el pie del dispensador  
pour distributeur à café (11672), 500 W, 220 V, directement dans le support

12287	500 W / 220 V
-------	---------------



**Heizplatte durch Spiralfeder an Wasserbad gedrückt**  
Heating plate is pressed against the water bath by a spiral spring

**Mobile Chafing Dish Heizung**

heating element  
resistencia  
résistance



**für alle marktgängigen Chafing Dishes**  
suitable for all current popular chafing dishes, with special spring  
para todos los chafing dish más corrientes  
pour la plupart des chafing dish les plus courants

	Ø cm	↑ cm	
12299	14	9 - 11	500 W / 220 V



**Elektro-Heizelement**

heating unit  
resistencia  
résistance

for chafer covers are closed most of the time



12290 360 W / 230 V



**Elektro-Heizelement**

heating unit  
resistencia  
résistance

for chafer covers are open most of the time



12292 600 W / 230 V



**Elektro-Heizelement**

heating unit  
resistencia  
résistance

for chafer covers are open most of the time

mit **einstellbarem Leistungsregler** / adjustable heat control / abiertos con termostato / contrôle de la chaleur réglable



12294 800 W / 230 V



**Brennpastenbehälter**

burner holder  
soporte para quemador  
porte-brûleur

nachfüllbar, für Chafing Dish, Deckel mit Bajonettverschluss

refillable, for Chafing Dish, lid with bayonet lock

recargable, para Chafing Dish, tapa con cierre de bayoneta

rechargeable, pour chafing dish, couvercle avec verrouillage par baïonnette



11683      Ø cm      ↑ cm  
9      6



**Speisenwärmer**

warmer  
calienta platos  
chauffe-plat

3-flammig / 3 lights / 3 velas / 3 bougies



35065      cm      ↑ cm  
34 x 18      6



**Speisenwärmer**

warmer  
calienta platos  
chauffe-plat

2-flammig / 2 lights / 2 velas / 2 bougies



35343      cm      ↑ cm  
34 x 13      6



**Wärme-Kies**

granite chips  
granulado térmico  
gravier thermique



für Chafing Dishes, feine Körnung, hohe Wärmespeicherung, kein Verkleben,  
ideal zum Warmhalten von Eiern

fine for chafing dishes and clean granite chippings, ideal for keeping eggs warm  
gravilla de granito fina limpia, ideal para mantener los huevos calientes  
gravier fin de granit, lavé, idéal pour maintenir les oeufs au chaud



81116 7



82274

Präsentationsmöglichkeit  
presentation example



**Besteckablage**

cutlery rest  
reposa cuchara  
pose-cuillère



cm ↑ cm

00650 27 x 11 3,5



**Besteckablage „SMALL WAVE“**

cutlery rest  
reposa cuchara  
pose-cuillère



cm ↑ cm

83897 26 x 13 4,5



**Besteckablage „BOWL“**

cutlery rest  
reposa cuchara  
pose-cuillère



cm ↑ cm ltr.

83803 22,5 x 11 6 0,5



**Besteckablage „SPOON“**

cutlery rest  
reposa cuchara  
pose-cuillère



cm ↑ cm

83801 26 x 10,5 5

# GN-CONTAINERS

## GN-Behälter Größen nach EN 631

Alle Behälter sind aus rostfreiem Chrom-Nickel-Edelstahl mit elektrolytisch polierter (seidenmatt) Oberfläche und somit perfekt geeignet für den professionellen Einsatz.

### GN-container according to EN 631

All pans are made of chrome/nickel stainless steel with a surface polished by electrolysis (satin-matt) and therefore highly suitable for professional operation.

### De conformidad con la norma europea EN 631.

Todos los contenedores están fabricados en acero inoxidable cromado/niquelado con su superficie (satinada) pulida por electrolisis lo que la hace altamente apropiado para el uso profesional.

### Bacs GN- Conforme à la norme EN 631

Tous les bacs sont fabriqués en inox/chrome/nickel, surface polie électrolythique (satiné). Approprié pour usage professionnel.

### Vorteile der rund geprägten U-Ecken:

- erhöhte Stabilität durch verstärktes Profil
- zielgerechtes und sauberes Ausgießen
- genaue Positionierung der GN-Behälter
- superleichtes Stapeln und Entstapeln
- kein Verklemmen der GN-Behälter
- hohe Stoßfestigkeit durch robuste Konstruktion
- ansprechendes Design und stilvoller Blickfang

### Advantages of the round-shaped U-Corners:

- increased stability due to the unique construction
- clean ladling and pouring
- exact positioning of the containers
- improved shock-resistance
- appealing design
- no seize of the containers

### Ventajas de las esquinas en U:

Perfil reforzado que confiere mayor rigidez y resistencia a la cubeta, diseño para verter fácil y limpiamente, fáciles de apilar y desapilar sin que se claven entre sí, construcción más robusta y resistente a los golpes mecánicos, diseño elegante.

### Avantages et fonctionnalité des angles en U:

Profil renforcé pour une meilleure consistance et rigidité du récipient, design qui facilite un versage propre et aisé, permet un empilage et désempilage faciles sans que les bacs restent coincés, meilleure résistance aux chocs mécaniques, seign élégant.

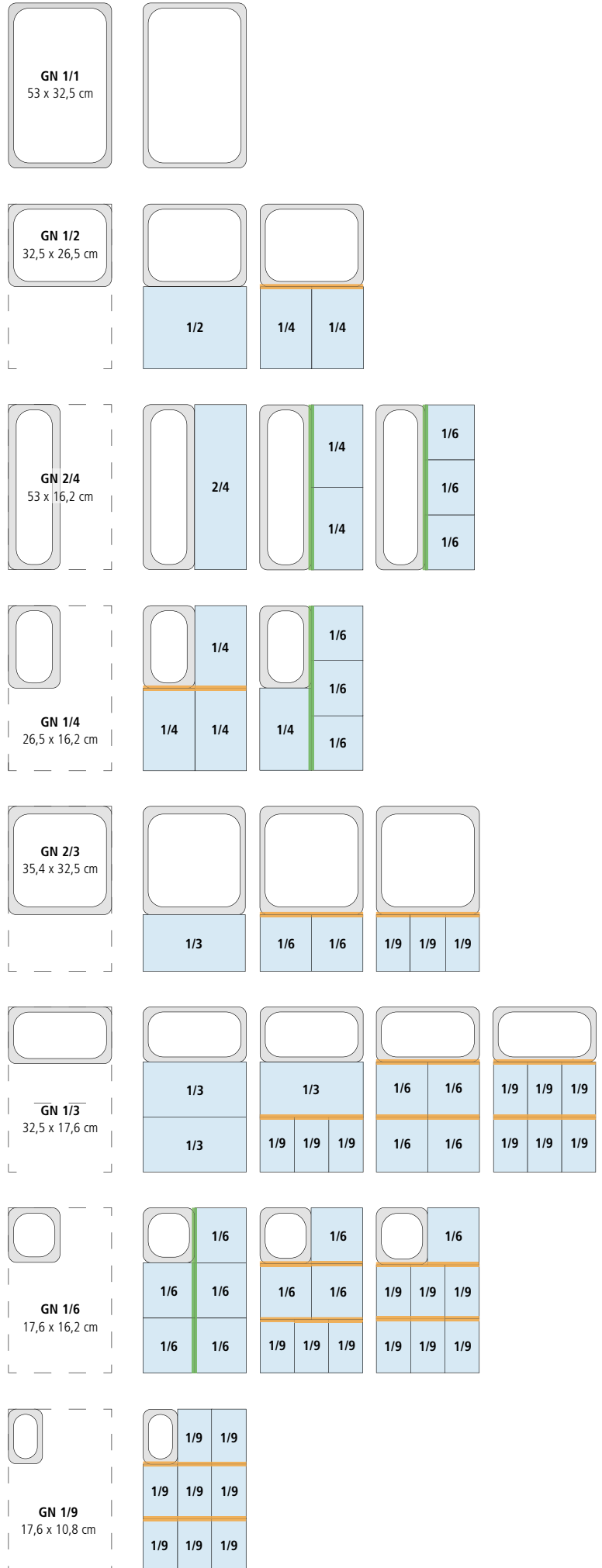





81102



81202



81302



81402



81604



81504



81702



81802

## GN-Behälter

GN-container

GN cubetas

GN bacs



	GN	↓ mm	ltr.	cm
81000	2/1	20	5,0	53,0 x 65,0
81095	1/1	10	1,25	53,0 x 32,5
81100	1/1	20	2,5	53,0 x 32,5
81101	1/1	40	5,0	53,0 x 32,5
81109	1/1	55	6,5	53,0 x 32,5
81102	1/1	65	9,0	53,0 x 32,5
81104	1/1	100	13,25	53,0 x 32,5
81106	1/1	150	20,0	53,0 x 32,5
81108	1/1	200	25,0	53,0 x 32,5

	GN	↓ mm	ltr.	cm
81200	1/2	20	1,0	32,5 x 26,5
81201	1/2	40	2,0	32,5 x 26,5
81209	1/2	55	2,8	32,5 x 26,5
81202	1/2	65	4,0	32,5 x 26,5
81204	1/2	100	6,0	32,5 x 26,5
81206	1/2	150	8,75	32,5 x 26,5
81208	1/2	200	11,65	32,5 x 26,5

	GN	↓ mm	ltr.	cm
81300	1/3	20	0,75	32,5 x 17,6
81302	1/3	65	2,5	32,5 x 17,6
81304	1/3	100	4,0	32,5 x 17,6
81306	1/3	150	5,7	32,5 x 17,6
81308	1/3	200	7,0	32,5 x 17,6

	GN	↓ mm	ltr.	cm
81400	1/4	20	0,5	26,5 x 16,2
81401	1/4	40	1,0	26,5 x 16,2
81402	1/4	65	1,8	26,5 x 16,2
81404	1/4	100	2,8	26,5 x 16,2
81406	1/4	150	4,0	26,5 x 16,2
81408	1/4	200	5,5	26,5 x 16,2

	GN	↓ mm	ltr.	cm
81602	1/6	65	1,0	17,6 x 16,2
81604	1/6	100	1,6	17,6 x 16,2
81606	1/6	150	2,4	17,6 x 16,2
81608	1/6	200	3,0	17,6 x 16,2

	GN	↓ mm	ltr.	cm
81502	1/9	65	0,6	17,6 x 10,8
81504	1/9	100	1,0	17,6 x 10,8
81506	1/9	150	1,5	17,6 x 10,8

	GN	↓ mm	ltr.	cm
81700	2/3	20	1,5	35,4 x 32,5
81701	2/3	40	3,0	35,4 x 32,5
81702	2/3	65	5,5	35,4 x 32,5
81704	2/3	100	8,4	35,4 x 32,5
81706	2/3	150	12,5	35,4 x 32,5
81707	2/3	200	18,0	35,4 x 32,5

	GN	↓ mm	ltr.	cm
81800	2/4	20	1,2	53,0 x 16,2
81801	2/4	40	2,4	53,0 x 16,2
81802	2/4	65	3,6	53,0 x 16,2
81804	2/4	100	5,6	53,0 x 16,2
81806	2/4	150	8,7	53,0 x 16,2

## GN-CONTAINERS



81903

81901

81905

### perforierte GN-Behälter perforated GN-container cubetas GN perforadas bacs GN perforés



	GN	↓ mm	cm
81911	1/1	40	53,0 x 32,5
81907	1/1	65	53,0 x 32,5
81908	1/1	100	53,0 x 32,5
81909	1/1	150	53,0 x 32,5
81910	1/1	200	53,0 x 32,5
81901	1/2	65	32,5 x 26,5
81902	1/2	100	32,5 x 26,5
81903	1/2	150	32,5 x 26,5
81904	1/2	200	32,5 x 26,5
81905	2/3	65	35,4 x 32,5
81906	2/3	100	35,4 x 32,5



### GN-Behälter Set, 4 teilig

GN-container, 4 pcs.  
GN cubetas, set de 4  
GN bacs, set de 4



**bestehend aus: Edelstahlbehälter 1x GN 1/2 + 2x GN 1/4 + 1 Adapter**

consisting of: stainless steel containers 1x GN 1/2 + 2x GN 1/4 + adapter

consiste en: cubetas de acero inoxidable 1x GN 1/2 + 2x GN 1/4 + adaptador

composé de: bacs en acier inox 1x GN 1/2 + 2x GN 1/4 + adaptateur

	GN	↓ mm	ltr.	cm	pcs
81850	1/2	65	4	32,5 x 26,5	1
	1/4	65	1,8	26,40 x 16,2	2
	Adapter			31,5	1

**GN-Deckel**

GN-lid  
GN tapa  
GN couvercle

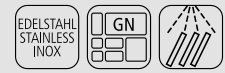
**ohne Löffelaussparung**

without notched edge for spoons  
sin agujero para cucharón  
sans espace pour louche

	GN	cm
81195	1/1	53,0 x 32,5
81295	1/2	32,5 x 26,5
81395	1/3	32,5 x 17,6
81495	1/4	26,5 x 16,2
81695	1/6	17,6 x 16,2
81591	1/9	17,6 x 10,8
81795	2/3	35,4 x 32,5
81895	2/4	53,0 x 16,2

**GN-Deckel**

GN-lid  
GN tapa  
GN couvercle

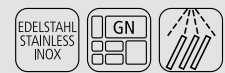
**mit Löffelaussparung**

with notched edge for spoons  
con agujero para cucharón  
avec espace pour louche

	GN	cm
81191	1/1	53,0 x 32,5
81292	1/2	32,5 x 26,5
81391	1/3	32,5 x 17,6
81492	1/4	26,5 x 16,2
81692	1/6	17,6 x 16,2
81595	1/9	17,6 x 10,8
81791	2/3	35,4 x 32,5
81891	2/4	53,0 x 16,2



Die Löffelaussparung mit Prägung verhindert das Zurückfließen von Flüssigkeit auf dem Deckel in den Behälter.

The notch for spoon with embossing prevents liquid on the lid from flowing back into the container.

## GN-CONTAINERS



### GN Transport-Steck-Deckel

GN-lid with silicone seal  
GN tapa hermética con junta  
GN couvercle hermétique avec joint



**Silikondichtung, Griffmulde und Loch gegen Unterdruck, schwappsicherer Transport nicht für Kombidämpfer geeignet**

silicone joint, flat handle, vent to compensate, slosh-proof transport, for pressure, not usable for steam oven  
junta de silicona, asa empotrada, válvula para compensar, transporte sin salpicaduras, la presión, no se puede utilizar en hornos de vapor  
joint silicone, anse encastrée, valve pour compenser la pression, transport sans éclaboussures, ne convient pas pour les étuves combinées

	GN	cm
80023	1/1	53,0 x 32,5
80024	1/2	32,5 x 26,5
80025	1/3	32,5 x 17,6
80026	1/4	26,5 x 16,2
80027	1/6	17,6 x 16,2
80028	2/4	53,0 x 16,2
80029	2/3	35,4 x 32,5



### Adapter / Zwischensteg

adapter  
adaptador  
adaptateur



**ermöglicht stabilen Halt von GN-Behältern im CD, rostfreier Chrom-Nickel-Edelstahl**

for fixing GN pans, chrome / nickel stainless steel  
para sujetar las cubetas GN, acero inox  
support stable pour les bacs GN

	cm	
81996	15,9	längs bei GN 1/4 / lengthwise GN 1/4 longitud GN 1/4 / GN 1/4 dans la longueur
81997	17,6	längs bei GN 1/9 / lengthwise GN 1/9 longitud GN 1/9 / GN 1/9 dans la longueur
81999	32,5	quer bei GN 1/2 / crosswise GN 1/2 de ancho GN 1/2 / GN 1/2 dans la largeur
81998	52,5	längs bei GN 1/1 / lengthwise GN 1/1 longitud GN 1/1 / GN 1/1 dans la longueur



### GN Abtropfgitter

GN-drainer  
GN escurridor  
GN égouttoir



**Abtropfgitter aus Edelstahl für Gastronorm Behälter, passend für GN 1/1 und GN 1/2**

stainless steel GN drainer for GN 1/1 + GN 1/2  
escurridor GN de acero inoxidable para GN 1/1 + GN 1/2  
égouttoir GN en acier inoxydable pour GN 1/1 + GN 1/2

	GN	cm	↑ cm
81117	1/1	45 x 25	1,5
81118	1/2	25 x 19	1,5

**GN-Behälter aus Polypropylen**

GN-container polypropylene  
GN cubetas polipropileno  
GN bacs polypropilène

**transparent: Skalierung in Liter, robust und formstabil**

transparent: liter scale, solid quality

transparente: graduación en litros, alta calidad

transparent: graduation en litres, haute-qualité

	GN	↓ mm	ltr.	cm
82104	1/1	65	8,5	53 x 32,5
82106	1/1	100	13,0	53 x 32,5
82108	1/1	150	19,5	53 x 32,5
82110	1/1	200	26,0	53 x 32,5

	GN	↓ mm	ltr.	cm
82112	1/2	65	3,9	32,5 x 26,5
82114	1/2	100	5,9	32,5 x 26,5
82116	1/2	150	8,9	32,5 x 26,5
82117	1/2	200	11,8	32,5 x 26,5

	GN	↓ mm	ltr.	cm
82118	1/3	65	2,4	32,5 x 17,5
82120	1/3	100	3,6	32,5 x 17,5
82122	1/3	150	5,3	32,5 x 17,6
82123	1/3	200	7,0	32,5 x 17,6

	GN	↓ mm	ltr.	cm
82128	1/4	65	1,7	26,5 x 16,2
82130	1/4	100	2,5	26,5 x 16,2
82132	1/4	150	3,7	26,5 x 16,2
82134	1/4	200	4,8	26,5 x 16,2

	GN	↓ mm	ltr.	cm
82136	1/6	65	1,0	17,6 x 16,2
82138	1/6	100	1,5	17,6 x 16,2
82140	1/6	150	2,2	17,6 x 16,2
82142	1/6	200	2,8	17,6 x 16,2

	GN	↓ mm	ltr.	cm
82150	1/9	65	0,6	17,6 x 10,8
82151	1/9	100	1,0	17,6 x 10,8



**stapelbar**  
stackable



**Skalierung**  
scaling

**GN-Deckel**

GN-lid  
GN tapa  
GN couvercle



	GN	cm
82101	1/1	53,0 x 32,5
82113	1/2	32,5 x 26,5
82119	1/3	32,5 x 17,6
82129	1/4	26,5 x 16,2
82137	1/6	17,6 x 16,2
82159	1/9	17,6 x 10,8

## GN-CONTAINERS



### GN-Behälter aus Polycarbonat

GN-container polycarbonate

GN cubeta policarbonato

GN bac polycarbonate



**transparent: Inhalt gut erkennbar, Skalierung in Liter, robust und formstabil**

transparent: content can be seen, liter scale, solid quality

transparente para ver el contenido, graduación en litros, alta calidad

transparent pour voir le contenu, graduation en litres, haute-qualité

	GN	↓ mm	ltr.	cm
82004	1/1	65	8,5	53 x 32,5
82006	1/1	100	13,0	53 x 32,5
82008	1/1	150	19,5	53 x 32,5
82010	1/1	200	26,0	53 x 32,5
	GN	↓ mm	ltr.	cm
82012	1/2	65	3,9	32,5 x 26,5
82014	1/2	100	5,9	32,5 x 26,5
82016	1/2	150	8,9	32,5 x 26,5
82017	1/2	200	11,8	32,5 x 26,5
	GN	↓ mm	ltr.	cm
82018	1/3	65	2,4	32,5 x 17,6
82020	1/3	100	3,6	32,5 x 17,6
82022	1/3	150	5,3	32,5 x 17,6
82023	1/3	200	7,0	32,5 x 17,6
	GN	↓ mm	ltr.	cm
82028	1/4	65	1,7	26,5 x 16,2
82030	1/4	100	2,5	26,5 x 16,2
82032	1/4	150	3,7	26,5 x 16,2
82034	1/4	200	4,8	26,5 x 16,2
	GN	↓ mm	ltr.	cm
82036	1/6	65	1,0	17,6 x 16,2
82038	1/6	100	1,5	17,6 x 16,2
82040	1/6	150	2,2	17,6 x 16,2
82042	1/6	200	2,8	17,6 x 16,2
	GN	↓ mm	ltr.	cm
82050	1/9	65	0,6	17,6 x 10,2
82051	1/9	100	1,0	17,6 x 10,2



### GN-Deckel

GN-lid

GN tapa

GN couvercle



	GN	cm
82001	1/1	53,0 x 32,5
82013	1/2	32,5 x 26,5
82019	1/3	32,5 x 17,6
82029	1/4	26,5 x 16,2
82037	1/6	17,6 x 16,2
82059	1/9	17,6 x 10,8



### GN Abtropfgitter

GN drainer

GN escurridor

GN égouttoir



	für GN	cm
82003	1/1	47,3 x 26,8
82005	1/2	26,8 x 20,8
82007	1/3	26,8 x 11,8

NEW

## BLACK GN CONTAINER



NEW



82065 GN 1/2 | 100 mm



82069 GN 1/3 | 100 mm



82073 GN 1/4 | 100 mm



82077 GN 1/6 | 100 mm



82081 GN 1/9 | 100 mm

## GN-Behälter aus Polycarbonat

GN-container polycarbonate

GN cubeta policarbonato

GN bac polycarbonate

schwarz: Skalierung in Liter, robust und formstabil

black: liter scale, solid quality

negro: graduación en litros, alta calidad

noir : graduation en litres, haute-qualité



	GN	↓ mm	ltr.	cm
82064	1/2	65	3,9	32,5 x 26,5
82065	1/2	100	5,9	32,5 x 26,5
82066	1/2	150	8,9	32,5 x 26,5
82068	1/3	65	2,4	32,5 x 17,6
82069	1/3	100	3,6	32,5 x 17,6
82070	1/3	150	5,3	32,5 x 17,6
82072	1/4	65	1,7	26,5 x 16,2
82073	1/4	100	2,5	26,5 x 16,2
82074	1/4	150	3,7	26,5 x 16,2
82076	1/6	65	1,0	17,6 x 16,2
82077	1/6	100	1,5	17,6 x 16,2
82078	1/6	150	2,2	17,6 x 16,2
82081	1/9	100	1,0	17,6 x 10,8

passende Deckel, S. 358  
suitable lid, page 358stapelbar  
stackable

## GN-CONTAINERS



### Backblech

baking sheet  
bandeja pastelera  
plaque à pâtisserie



geloht Ø 3 mm, Materialstärke 1,5 mm, Silikon beschichtet, temperaturbeständig bis 240°C  
perforated Ø 3 mm, coated with silicon, heat resistant up to 240°C  
aluminio con revestimiento de silicona perforada, resistente hasta 240°  
aluminium avec revêtement silicone, perforée, température maxi 240°

	GN	cm
88285	1/1	53 x 32,5

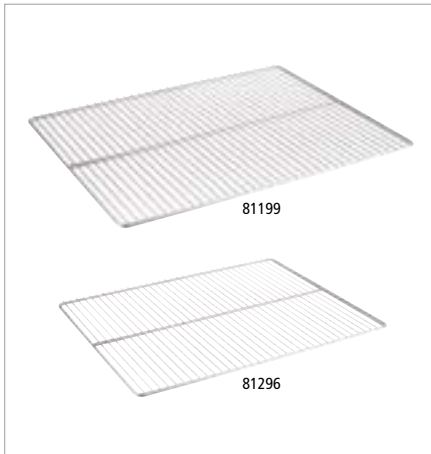

### GN Roste

GN grid  
GN rejilla  
GN grille



elektrolytisch poliert, Drahtstärke 3 mm, Rahmendraht 6 mm, extra schwere Qualität  
electro-polished, wire thickness 3 mm, frame wire 6 mm, extra heavy quality  
inox pulido electrolítico, grosor alambre 3 mm, grosor marco 6 mm, calidad reforzada  
inox poli électrolytique, fil 3 mm, cadre 6 mm, qualité renforcée

	GN	cm
81199	2/1	65,0 x 53,0
81198	1/1	53,0 x 32,5
81796	2/3	32,5 x 35,4
81296	1/2	32,5 x 26,5



### GN 1/3 Bestecksammler

GN 1/3 container  
GN 1/3 cubeta  
GN 1/3 bac



mit 2 Haken zum Einhängen an Servier- oder Transportwagen  
container with 2 hooks, to hang on trolleys for cutlery  
cubeta con 2 ganchos para cubiertos, a colgar del carro  
bac à couverts avec 2 crochets, à accrocher au chariot

	GN	↓ mm	cm
11978	1/3	150	32,5 x 17,5



### GN Tablett „FRAMES“

GN tray  
GN bandeja  
GN plateau



	GN	↑ cm	cm
82355	1/1	2	53,0 x 32,5
82356	1/2	2	32,5 x 26,5
82357	1/3	2	32,5 x 17,6





# PORCELAIN GN CONTAINERS



**GN-Behälter**  
GN-container  
GN cubetas  
GN bac



	GN	↓ mm	ltr.	cm
82100	1/1	60	7,1	53,0 x 32,5
82200	1/2	60	3,4	32,5 x 26,5
82300	1/3	60	2,0	32,5 x 17,6
82306	2/3	60	4,6	35,4 x 32,5
82301	2/4	60	3,0	53,0 x 16,2



**GN-Behälter**  
GN-container  
GN cubeta  
GN bac

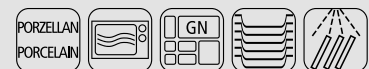

	GN	↓ mm	ltr.	cm	Farbe / colour
82270	1/1	60	7,1	53,0 x 32,5	Yellow
82271	1/1	60	7,1	53,0 x 32,5	Green
82272	1/1	60	7,1	53,0 x 32,5	Red
82273	1/1	60	7,1	53,0 x 32,5	Black
82274	1/2	60	3,4	32,5 x 26,5	Yellow
82275	1/2	60	3,4	32,5 x 26,5	Green
82276	1/2	60	3,4	32,5 x 26,5	Red
82277	1/2	60	3,4	32,5 x 26,5	Black
82278	1/3	60	2,0	32,5 x 17,6	Yellow
82279	1/3	60	2,0	32,5 x 17,6	Green
82280	1/3	60	2,0	32,5 x 17,6	Red
82281	1/3	60	2,0	32,5 x 17,6	Black



Präsentationsmöglichkeit  
presentation example

# GN-CONTAINERS



## GN-Behälter „ECOLINE“

GN container

GN cubeta

GN bac

mit Stapelnocke

with notching edge

con borde marcado para el apilado

avec rebord pour l'empilage



	GN	↓ mm	ltr.	cm	Farbe / Colour
83759	1/1	65	7,10	53,0 x 32,5	White
83755	2/4	65	3,00	53,0 x 16,2	White
83757	1/2	65	3,40	32,5 x 26,5	White
83753	1/3	65	2,00	32,5 x 17,6	White
83751	1/4	65	1,35	26,5 x 16,2	White
83749	1/6	65	0,80	17,6 x 16,2	White

	GN	↓ mm	ltr.	cm	Farbe / Colour
83758	1/1	65	7,10	53,0 x 32,5	Black
83754	2/4	65	3,00	53,0 x 16,2	Black
83756	1/2	65	3,40	32,5 x 26,5	Black
83752	1/3	65	2,00	32,5 x 17,6	Black
83750	1/4	65	1,35	26,5 x 16,2	Black
83748	1/6	65	0,80	17,6 x 16,2	Black

	GN	↓ mm	ltr.	cm	Farbe / Colour
84300	1/1	100	10,6	53,0 x 32,5	White
84302	2/4	100	4,3	53,0 x 16,2	White
84301	1/2	100	4,7	32,5 x 26,5	White
84303	1/3	100	2,7	32,5 x 17,6	White
84304	1/4	100	1,9	26,5 x 16,2	White
84305	1/6	100	1,0	17,6 x 16,2	White

	GN	↓ mm	ltr.	cm	Farbe / Colour
84306	1/1	100	10,6	53,0 x 32,5	Black
84308	2/4	100	4,3	53,0 x 16,2	Black
84307	1/2	100	4,7	32,5 x 26,5	Black
84309	1/3	100	2,7	32,5 x 17,6	Black
84310	1/4	100	1,9	26,5 x 16,2	Black
84311	1/6	100	1,0	17,6 x 16,2	Black



## GN-Deckel

GN-lid

GN tapa

GN couvercle



	GN	cm
82001	1/1	53,0 x 32,5
82013	1/2	32,5 x 26,5
82019	1/3	32,5 x 17,6
82029	1/4	26,5 x 16,2
82037	1/6	17,6 x 16,2



83762

83763

**GN-Behälter „HIGHLINE“**

GN-container

GN cubeta

GN bac

mit Stapelnocke

with notching edge

con borde marcado para el apilado

avec rebord pour l'empilage



	GN	↓ mm	ltr.	cm
83772	1/1	65	7,10	53,0 x 32,5
83768	1/2	65	3,40	32,5 x 26,5
83766	2/4	65	3,00	53,0 x 16,2
83764	1/3	65	2,00	32,5 x 17,6
83762	1/4	65	1,35	26,5 x 16,2
83760	1/6	65	0,80	17,6 x 16,2

	GN	↓ mm	ltr.	cm
83773	1/1	100	11,0	53,0 x 32,5
83769	1/2	100	5,50	32,5 x 26,5
83765	1/3	100	3,15	32,5 x 17,6
83763	1/4	100	2,20	26,5 x 16,2
83761	1/6	100	1,25	17,6 x 16,2



83768



83401

83479

**Tablett „PURE“**

tray

bandeja

plateau



	cm	↑ cm	GN	Farbe / Colour
83401	53,0 x 32,5	3	1/1	White
83433	53,0 x 16,2	3	2/4	White
83480	32,5 x 26,5	3	1/2	White
83481	32,5 x 17,6	3	1/3	White
83482	26,5 x 16,2	3	1/4	White

83597	40,0 x 30,0	3	Bäcker-Maß	White
-------	-------------	---	------------	-------

	cm	↑ cm	GN	Farbe / Colour
83479	53,0 x 32,5	3	1/1	Black
83434	53,0 x 16,2	3	2/4	Black
83490	32,5 x 26,5	3	1/2	Black
83491	32,5 x 17,6	3	1/3	Black
83492	26,5 x 16,2	3	1/4	Black

83592	40,0 x 30,0	3	Bäcker-Maß	Black
-------	-------------	---	------------	-------

## SERVING TROLLEYS



### Servier- / Transportwagen

serving trolley  
carro de servicio  
chariot de service



Gestell aus Vierkantrohr 25 x 25 mm, Ablagefläche innen 84 x 44,5 cm, Bodenfläche 90 x 50 cm, auf Unterseite schalldämmend beschichtet, Abstand zwischen den Böden 28 cm / 29 cm, mit 4 Lenkrollen Ø 12,5 cm, alle mit Feststellern, Lieferung demontiert, einfache Montage, Tragfähigkeit 33 kg je Boden

frame rectangular bar 25 x 25 mm, shelf board inside 84 x 44,5 cm, shelf board outside 90 x 50 cm, undersurface coated sound-damping, distance between the boards 28 cm / 29 cm, with 4 swivel wheels Ø 12,5 cm, all with brakes, unassembled, simple assembly, max load 33 kg per shelf

estructura tubo cuadrado 25 x 25 mm, útiles int. por piso 84 x 44,5 cm. ext. al suelo 90 x 50 cm revestimiento para absorber ruidos distancia entre pisos 28 cm / 29 cm, 4 ruedas giratorias 12,50 cm, con frenos, se sirve desmontado, montaje fácil, carga máx. 33 kg por piso

structure en tube carré 25x25 mm, 3 niveaux dimensions utiles 84x44,5 cm, encombrement au sol 90x50 cm, avec revêtement en partie inférieure pour absorber le bruit, distance entre niveaux 28 cm / 29 cm, roues pivotantes 12,5 cm, avec frein, livré démonté, montage aisé, max. 33 kg de charge par niveau

	cm	↑ cm
71440	96 x 50	94



### Servier- / Transportwagen

service trolley  
carro de servicio  
chariot de service



mit 3 Borden, Bordmaße 83 x 51 cm, Abstand zwischen den Borden 26 cm, Tragfähigkeit 120 kg, 4 Lenkrollen, davon 2 feststellbar, Lieferung demontiert, einfache Montage

with 3 trays, trays 83 x 51 cm, size between the trays 26 cm, total load capacity 120 kg, 4 wheels with 2 brakes, unassembled, simple assembly

con 3 bandejas inox mate, 83 x 51 cm, la medida entre bandejas 26 cm, capacidad total 120 kg, 4 ruedas con 2 frenos, construcción robusta, montaje fácil

3 niveaux, 83x51 cm chacun, distance entre niveaux 26 cm, capacité maxi 120 kg au total, 4 roues dont 2 avec frein, construction robuste, montage facile

	cm	↑ cm
11979	91 x 59	93



### Servier- / Transportwagen

service trolley  
carro de servicio  
chariot de service



mit 2 Borden, Bordmaße ca. 83 x 51 cm, Abstand zwischen den Borden ca. 56 cm, Tragfähigkeit 80 kg, 4 Lenkrollen, davon 2 feststellbar, Lieferung demontiert, einfache Montage

with 2 trays, trays 83 x 51 cm, size between the trays 56 cm, total load capacity 80 kg, 4 wheels with 2 brakes, unassembled, simple assembly

con 2 bandejas de acero inoxidable mate, 83 x 51 cm, la medida entre bandejas 56 cm, capacidad total 80 kg, 4 ruedas, con 2 frenos, construcción robusta, montaje fácil

2 niveaux, 83x51 cm chacun, distance entre niveaux 56 cm, capacité maxi 80 kg au total, 4 roues dont 2 avec frein, construction robuste, montage facile

	cm	↑ cm
11977	91 x 59	93

**Servier- / Transportwagen**

serving trolley  
carro de servicio  
chariot de service



Aluminiumrahmen, 3 Böden, Abstand zwischen den Böden 31 cm, mit 4 Lenkrollen, alle mit Feststellern, Tragfähigkeit: 50 kg je Boden, 150 kg insgesamt, demontiert, einfache Montage, Lieferung ohne Container und Dekoration

frame aluminium, 3 shelves, distance between shelves 31 cm, 4 swivel wheels, all equipped with brakes, max. load per shelf 50 kg, 150 kg total, demounted, easy to mount, delivery without containers and decoration

marco aluminio, 3 pisos, distancia entre cada piso 31 cm, 4 ruedas giratorias, las 4 con frenos, carga máxima por bandeja 50 kg, 150 kg en total, se sirve desmontado, fácil de montar (se entrega sin contenedores ni decoración)

chassis aluminium, 3 étages, distance entre niveaux 31 cm, 4 roues pivotantes, toutes avec frein, charge maximum 50 kg par niveau, 150 kg au total, livré démonté, montage facile (livré sans récipients ni décoration)

	cm	↑ cm	
11945	108 x 50	96	without containers

**Container zum Einhängen, passend zum Servier- / Transportwagen 11945**

container to hang up, suitable serving trolley 11945  
contenedor para colgar, adaptado para el carro ref. 11945  
récipient à suspendre, pour chariot de service 11945

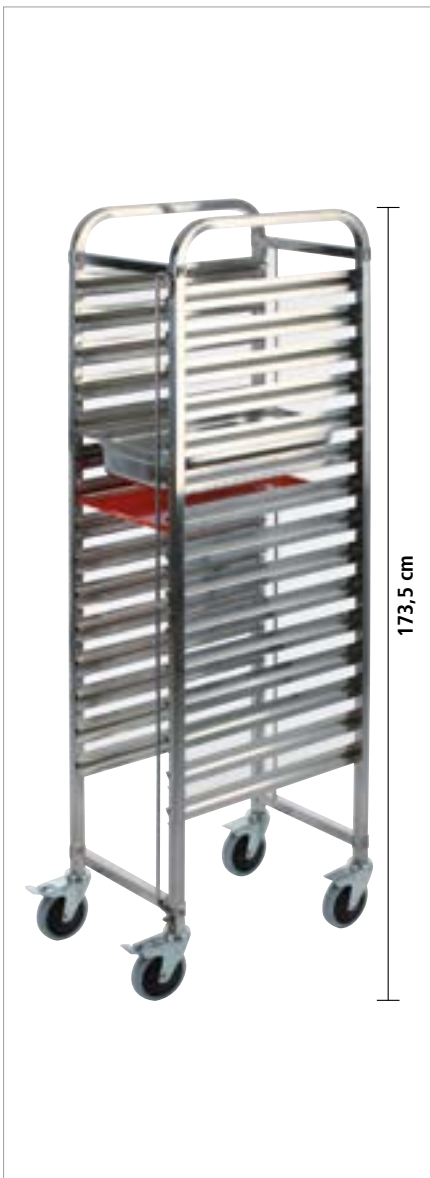

	cm	↑ cm	ltr.
11946	33 x 23	56,5	42
11947	33 x 23	17,5	13

**GN 1/1 Regalwagen**

GN 1/1 trolley  
GN 1/1 carro  
GN 1/1 chariot



mit 15 Doppelauflegeschieben, zum Transport von bis zu 30 GN-Tablets GN 1/2 oder 15 GN-Behältern bis GN 1/1 (Längseinschub), bei einem Stapelabstand von 75 mm, mit 4 Lenkrollen, 2 mit Feststellern, Tragfähigkeit 100 kg

15 double bars, for transporting up to 30 trays GN 1/2 or 15 GN containers up to GN 1/1 (lengthwise insertion), size between the trays 75 mm, with 4 swivel wheels, 2 with brakes, max. load 100 kg

15 raíles de soporte dobles, para transportar hasta 30 bandejas GN 1/2 o 15 cubetas GN hasta GN 1/1 (inserción longitudinal), distancia entre las bandejas de 75 mm, con 4 ruedas giratorias, 2 con freno, carga máxima de 100 kg

15 doubles rails de support, pour transporter jusqu'à 30 plateaux GN 1/2 ou 15 bacs GN jusqu'à GN 1/1 (insertion longitudinale), distance entre les plateaux 75 mm, avec 4 roues pivotantes, 2 avec frein, capacité de charge 100 kg

	cm	↑ cm
71441	55 x 38,5	173,5



mit beidseitiger Kipp- und Durchschubsicherung  
with tilt and push-through protection on both sides

## CUTLERY BOXES



### Besteckbehälter

cutlery box  
recipiente para cubiertos  
réceptif pour couverts

**Akazienholz, 4 Fächer (26 x 11,5 cm)**

acacia wood, 4 compartments (26 x 11,5 cm)  
madera de acacia, 4 compartimentos (26 x 11,5 cm)  
bois d'acacia, 4 compartiments (26 x 11,5 cm)



	cm	↑ cm	Farbe / Colour	
11952	51 x 28	13		nature
11951	51 x 28	13		vintage white



### Besteckbehälter mit Deckel

cutlery box with cover  
caja de cubiertos con tapa  
range-couverts avec couvercle

**Akazienholz, 4 Fächer (26 x 11,5 cm), mit Deckel**

acacia wood, 4 compartments (26 x 11,5 cm), with cover  
madera de acacia, 4 compartimentos (26 x 11,5 cm), con tapa  
bois d'acacia, 4 compartiments (26 x 11,5 cm), avec couvercle



	cm	↑ cm	Farbe / Colour	
11949	51 x 28	14,5		nature
11948	51 x 28	14,5		vintage white



### GN 1/1 Besteckbehälter

GN 1/1 dispenser GN  
GN 1/1 dispensador de cubiertos  
GN 1/1 bac à couverts

**in Handarbeit geflochten, 4 Mulden, Kunststoff-Geflecht, Drahtgestell, braun-schwarz**

hand-woven, 4 troughs, plastic wickerwork, wire frame, brown-black  
cesta trensada a mano, 4 compartimentos, mimbre de plástico, marco de alambre, marrón-negro  
corbeille tressée à main, 4 compartiments, plastique tressé, armature en fil métallique, brun-noir



	cm	↑ cm	Farbe / Colour	GN
11966	53 x 32,5	9		1/1



### GN 1/1 Besteckbehälter

GN 1/1 cutlery dispenser  
GN 1/1 dispensador de cubiertos  
GN 1/1 bac à couverts

**4 Mulden, Kunststoff-Geflecht, Drahtgestell, beige**

4 troughs, plastic wickerwork, wire frame, beige  
4 compartimentos, mimbre de plástico, marco de alambre, beige  
4 compartiments, plastique tressé, structure métallique, beige



	cm	↑ cm	Farbe / Colour	GN
11965	53 x 32,5	10		1/1

**GN 1/1 Besteckbehälter**

GN 1/1 cutlery bin  
GN 1/1 recipiente para cubiertos  
GN 1/1 récipients pour couverts

**4 Mulden**

4 troughs  
4 compartimentos  
4 compartments

	cm	↑ cm	Farbe / Colour	GN
11954	53 x 32,5	10	■	1/1
11955	53 x 32,5	10	■	1/1

**3 Mulden, 3 Köcher**

3 troughs, 3 cutlery baskets  
3 compartimentos, 3 cestas para cubiertos  
3 compartments, 3 corbeilles à couverts

	cm	↑ cm	Farbe / Colour	GN
11960	53 x 32,5	10	■	1/1

**Besteckbehälter**

cutlery basket  
recipiente para cubiertos  
récipients pour couverts

**4 Löcher inklusive 4 Edelstahl Köcher**

4 holes including 4 stainless baskets  
4 agujeros con 4 cestas de acero inoxidable  
4 trous avec 4 corbeilles en acier inox

	cm	↑ cm	Farbe / Colour
93321	27 x 27	15	■

**Besteckköcher**

cutlery basket  
cesta para cubiertos  
corbeille à couverts



Polyethylen weiß / polyethylene white plastic / polietileno blanco / polyéthylène blanc

	Ø cm	↑ cm
11998	9,5	13,5

Edelstahl matt poliert / stainless steel matt polished / acero inoxidable pulido mate / acier inox poli mat

	Ø cm	↑ cm
11999	9,5	13,5

**Besteckkasten „INDUSTRIAL“**

cutlery box  
caja para cubiertos  
boîte pour couverts

**schwarz, mit Beschriftungsfach 6,5 x 2,5 cm**

black, with labelling compartment 6,5 x 2,5 cm  
negro, con compartimento de etiquetado 6,5 x 2,5 cm  
noir, avec compartiment pour l'étiquetage 6,5 x 2,5 cm

	cm	↑ cm	litr.
40676	23,0 x 15,5	13,0	2,4



**Teig- und Pizzaballenbehälter**  
 dough and pizza ball container  
 recipiente para masa y bolas de pizza  
 récipient à pâte et boules à pizza



**Innenmaß 56,5 x 36,5 cm, H: 6,5 cm**  
 inner dimension 56,5 x 36,5 cm, H: 6,5 cm  
 medida interior 56,5 x 36,5 cm, H: 6,5 cm  
 dimension intérieure 56,5 x 36,5 cm, H: 6,5 cm

	cm	↑ cm	ltr.
82440	60 x 40	7	13



**stapelbar**  
 stackable

**passender Deckel / fitting lid / tapa adecuada / couvercle approprié**

	cm	↑ cm	
82441	60 x 40	1	



**Eier-Box**  
 eggs box  
 caja para huevos  
 boîte à oeufs



**mit luftdichtem Deckel, für 4 Lagen à 30 Eier, Lieferung inkl. 8 Lagen, Größe Lage: 28 x 28 cm**  
 with airtight cover, capacity: 4 trays of 30 eggs, delivery with 8 trays, size of tray: 28 x 28 cm  
 capacidad para 4 bandejas de 30 huevos, tapa hermética, se entrega con 8 bandejas, formato bandejas 28 x 28 cm, apto para lavavajillas  
 pour 4 plateaux de 30 oeufs chacun, apte pour 4 plateaux plats, couvercle hermétique, livré avec 8 plateaux, dimension plateau 28x28 cm, lavable en lave-vaisselle

	cm	↑ cm	GN
82419	35,4 x 32,5	20	2/3

**10 Lagen / 10 trays / 10 bandejas / 10 plateaux**

82420



**Wanne**  
 container  
 cubeta  
 bac



	cm	↑ cm	ltr.
11940	61 x 44	15	25



**Wanne**  
 container  
 cubeta  
 bac



	cm	↑ cm	ltr.
11950	55 x 42	14	20





**Profi-Eimer**  
bucket  
cubo  
seau



mit Ausgießer und geprägter Maßskalierung innen  
with spout and embossed dimension scaling inside  
con pico y escala de medición en relieve en el interior  
avec bec verseur et échelle de mesure en relief à l'intérieur

	Ø cm	↑ cm	ltr.	Farbe / Colour
30075	28,5	28,5	10,5	White
30076	33,0	32,0	17,0	White
30077	28,5	28,5	10,5	Black
30078	33,0	32,0	17,0	Black



mit Griff  
with handle



Maßskalierung innen  
dimension scaling inside



Auslaufnase für sicheres Handling  
discharge nose for safe handling



**Trichter „PROFI“**  
funnel  
embudo  
entonnoir



mit Öse  
with eyelet  
con ojal  
avec œillet

	Ø cm	Ø mm Durchlass	
30065	6	8	
30066	8	11	
30067	10	12	
30068	12	12	
30069	14	15	
30070	17	17	mit Sieb / incl. strainer
30071	21	20	mit Sieb / incl. strainer



erleichtert das Einfüllen  
facilitates filling



Anwendungsmöglichkeit  
applicability



mit einsetzbarem Sieb  
incl. insertable strainer





# Bar, Café Drinkware

BOTTLE COOLERS.....	372
BEVERAGE DISPENSERS.....	383
DRINKING CUPS.....	385
MOSCOW MULE.....	388
COOL MUGS.....	391
PINEAPPLE MUGS.....	392
JULEP MUGS.....	393
MINI FIRE PUNCH BOWL SETS.....	394
SHAKERS.....	395
JIGGERS.....	397
BAR SPOONS.....	399
BAR STRAINERS.....	400
MUDDLERS.....	402
LEMON SQUEEZERS.....	403
ICE CUBE MAKERS.....	404
ICE BUCKETS.....	405
TONGS.....	407
STRAWS.....	408
DRIP MATS.....	409
CONFERENCE BOTTLE COOLER.....	410
POURERS.....	411
CORKSKREWS   BARBLADES.....	413
BARISTA.....	414
TEAPOTS.....	419
TRAYS.....	420
FAST FOOD TRAYS.....	425
BILL PRESENTERS   CRUMBERS.....	426
ASHTRAYS.....	427
BINS.....	431
TO GO.....	432

## BOTTLE COOLERS

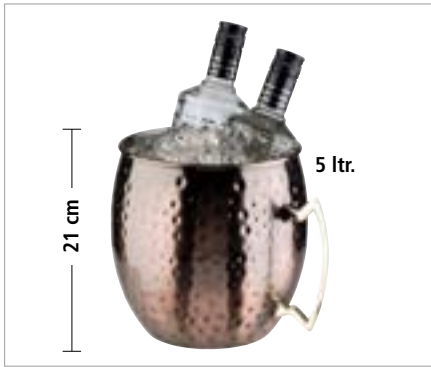

### Flaschenkühler „MOSCOW MULE“

bottle cooler  
enfriador de botellas  
rafraîchisseur de bouteilles

**Edelstahl-Flaschenkühler, Antik-Kupfer-Look**

stainless steel cooler, copper antique look  
enfriador de acero inoxidable, cobre estilo antiguo  
rafraîchisseur en acier inox, cuivre style antique



	Ø cm	↑ cm	ltr.	
93330	20	21	5	copper-antique-hammered



### Wein- / Sektkühler

wine / champagne bowl  
cubitera para vino y cava  
seau à vin ou champagne



**schwarz matt, mit 2 Griffen, extra stabiler eingerollter Rand**

black matt, with 2 handles, rolled edge  
negro mate, con 2 asas, borde redondeado  
noir mat, avec 2 poignées, bord arrondi

	Ø cm	↑ cm	ltr.
36115	21,5 / 15	22	5



### Wein- / Sektkühler

wine / champagne bowl  
cubitera para vino y cava  
seau à vin ou champagne



**innen matt poliert, außen hochglanzpoliert, mit massiven Knopf-Griffen, extra stabiler eingerollter Rand, schwere Ausführung**

outside mirror polished, inside matt polished, with solid knob handles, rolled edge, heavy quality  
exterior pulido brillante, interior pulido mate, asas de botón robustas, borde redondeado, alta calidad  
extérieur poli brillant, intérieur poli mat, 2 poignées robuste en forme de bouton, bord arrondi, haute qualité

	Ø cm	↑ cm	ltr.
36028	21,5 / 16	22	4



### Wein- / Sektkühler „HAMMERSCHLAG“

wine / champagne bowl  
cubitera para vino y cava  
seau à vin ou champagne



**hochglanzpoliert, mit massiven Ring-Griffen, eingerollter Rand**

mirror polished, with solid ring handles, rolled edge, hammered  
pulido brillante, con 2 anillos macizos, borde redondeado, repujado  
brillant, 2 anneaux massifs, bord arrondi, surface martelée

	Ø cm	↑ cm	ltr.
36026	21 / 17	21,5	4



### Wein- / Sektkühler

wine / champagne bowl  
cubitera para vino y cava  
seau à vin ou champagne



**innen matt poliert, außen hochglanzpoliert, mit massiven Griffen, Rand eingerollt**

outside mirror polished, inside matt polished, with massive handles, rolled edge  
exterior pulido brillante, interior pulido mate, 2 asas macizas, borde redondeado  
extérieur poli brillant, intérieur poli mat, 2 anses massives, bord rond

	Ø cm	↑ cm	ltr.
36025	21 / 15	21	3,5



**Wein- / Sektkühler**

wine / champagne bowl  
cubitera para vino y cava  
seau à vin ou champagne

**matt poliert, Hohlgriffe**

matt polished, hollow handles  
pulido mate, con asas huecas  
poli mat, 2 boutons creux



	Ø cm	↑ cm	ltr.
36021	20 / 15	20,5	4



**Wein- / Sektkühler**

wine / champagne bowl  
cubitera para vino y cava  
seau à vin ou champagne

**aussen hochglanzpoliert, innen matt poliert, mit Ring-Griffen**

outside mirror polished, inside matt polished, with ring handles  
exterior pulido brillante, interior pulido mate, con 2 asas anillos  
extérieur poli brillant, intérieur poli mat, avec 2 anneaux



	Ø cm	↑ cm	ltr.
36020	20 / 15	19	3



**Wein- / Sektkühler**

wine / champagne bowl  
cubitera para vino y cava  
seau à vin ou champagne

**glasklarer Rand, transparent gefrostet**

edge transparent, body transparent frosted  
borde transparente, cuerpo transparente efecto glaseado  
bord transparent, corps poli mat



	Ø cm	↑ cm	ltr.
36066	22 / 14	23	4



**Wein- / Sektkühler**

wine / champagne bowl  
cubitera para vino y cava  
seau à vin ou champagne

**glasklar, mit Tragegriff**

transparent, handle on the side  
transparente, con un asa en el lateral  
transparent, avec poignée



	cm	↑ cm	ltr.
36055	23 x 22	27,5	3



**Mini-Eiseimer / Mini-Sektkühler**

ice bucket  
cubitera clásica  
seau à glaçons classique



	Ø cm	↑ cm	ltr.
36003	10,5	10	0,5
36004	13,0	13	1,0

## BOTTLE COOLERS



### Ständer für Wein- / Sektkühler

stand for wine / champagne bowl  
pie porta champañera / vino  
ped pour seau à champagne / vin



hochglanzpoliert, schwerer standsicherer Fuß, Innendurchmesser der Schale Ø 17,5 cm  
mirror polished, heavy foot, inner bowl Ø 17,5 cm  
acabado pulido efecto brillante, bol interior de Ø 17,5 cm  
brillant, intérieur support Ø 17,5 cm

	Ø cm	↑ cm
36069	17,5 / 26,5	73



#### Wein- / Sektkühler no. 36028

wine / champagne bowl no. 36028  
cubitera para vino y cava no. 36028  
seau à vin ou champagne no. 36028



### Ständer für Wein- / Sektkühler

stand for wine / champagne bowl  
pie porta champañera / vino  
ped pour seau à champagne / vin



hochglanzpoliert, schwerer standsicherer Fuß, Innendurchmesser der Schale Ø 15 cm  
mirror polished, heavy foot, inner bowl Ø 15 cm  
acabado pulido efecto brillante, bol interior de Ø 15 cm  
brillant, intérieur support Ø 15 cm

	Ø cm	↑ cm
36068	15 / 28	68



### Ständer für Wein- / Sektkühler

stand for wine / champagne bowl  
pie porta champañera / vino  
ped pour seau à champagne / vin



schwarz matt, schwerer standsicherer Fuß, Innendurchmesser der Schale Ø 15 cm  
black matt, heavy stable foot, inner bowl Ø 15 cm  
negro mate, pie pesado y estable, bol interior de Ø 15 cm  
noir mat, pied lourd et stable, intérieur support Ø 15 cm

	Ø cm	↑ cm
36116	19,5 / 26,5	71,5

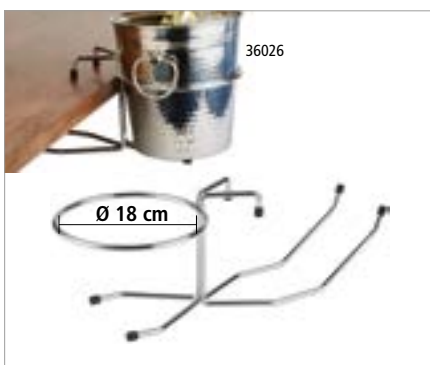
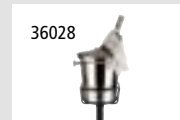

### Tischhalterung für Sektkühler

champagne bucket table holder  
soporte champañera universal  
porte-seau à champagne



aus 8 mm starkem Stahldraht, passen zu allen lieferbaren Sektkühlern, innen Ø-Ring: 18 cm  
8 mm chrome plated wire, suitable for all available champagne buckets, inner ring Ø 18 cm  
alambre cromado 8 mm, para todas las champañeras, anillo interior Ø 18 cm  
fil chromé 8 mm, pour tous les seaux à champagne, anneau intérieur Ø 18 cm

	cm	↑ cm
30332	49 x 20	17



**Flaschenkühler**

bottle cooler  
enfriador de botella  
rafraîchisseur de bouteille

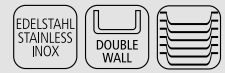

**doppelwandig für beste Isolierung, außen Hammerschlag-Optik**

double-walled for best insulation, outside: hammered surface  
doble pared para un mejor aislamiento, exterior: aspecto martillado  
double paroi pour une meilleur isolation, extérieur: surface martelée

	Ø cm	↑ cm	ltr.	Farbe / Colour
36120	33	20	8	stainless
36121	33	20	8	copper-look



Präsentationsmöglichkeit  
presentation examples



**Wein- / Sektkühler „XL“**

wine / champagne bowl  
cubitera para vino y cava  
seau à vin ou champagne



**gehämmerte Oberfläche, mit 2 seitlichen Eingriffen**

hammered surface, with 2 handles on the side  
superficie martillada, con 2 asas  
surface martelée, avec 2 poignées

	cm	↑ cm	ltr.	Farbe / Colour
36111	30 x 23,5	23	7	copper-look
36112	30 x 23,5	23	7	gunmetal-look



**Wein- / Sektkühler „LARGE“**

wine / champagne bowl  
cubitera para vino y cava  
seau à vin ou champagne



**gehämmerte Oberfläche, mit 2 seitlichen Eingriffen, für 1-2 Flaschen**

hammered surface, with 2 handles on the side, for 1-2 bottles  
superficie martillada, con 2 asas, para 1-2 botellas  
surface martelée, avec 2 poignées, pour 1-2 bouteilles

	cm	↑ cm	ltr.	Farbe / Colour
36108	25,5 x 19	20	3,9	copper-look
36109	25,5 x 19	20	3,9	gunmetal-look

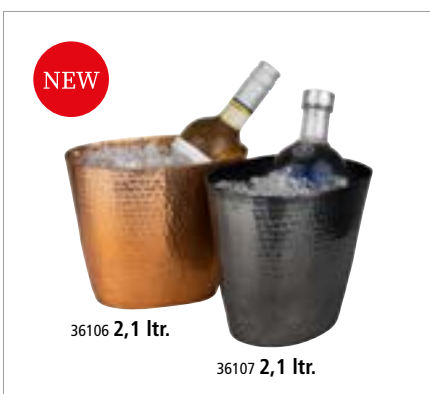

**Wein- / Sektkühler „SMALL“**

wine / champagne bowl  
cubitera para vino y cava  
seau à vin ou champagne



**gehämmerte Oberfläche, für 1 Flasche**

hammered surface, for 1 bottle  
superficie martillada, para 1 botella  
surface martelée, pour 1 bouteille

	cm	↑ cm	ltr.	Farbe / Colour
36106	20,5 x 14	17	2,1	copper-look
36107	20,5 x 14	17	2,1	gunmetal-look

## BOTTLE COOLERS



### Flaschenkühler „BRIDGE“

bottle cooler  
enfriador de botellas  
rafraîchisseur de bouteilles



**doppelwandig für beste Isolierung, außen hochglanzpoliert, innen matt poliert**

double wall cooler keeps the temp. for a long time, outs. mirror polished, inside matt polished  
champañera inox de doble pared, interior pulido mate, exterior pulido brillante  
seau inox double paroi, maintient le froid plus longt., intérieur poli mat, extérieur poli brillant

	Ø cm	↑ cm	ltr.
36077	31	19	10



### Champagnerkühler

champagne bowl  
cubo champañera  
seau à champagne



**hochglanzpoliert, doppelwandig für beste Isolierung**

mirror polished, double wall cooler keeps the temp. for a long time  
pulido brillante con champañera inox de doble pared  
poli brillant, double paroi, maintient le froid plus longtemps

	Ø cm	↑ cm	ltr.
36044	44 / 25	24	10,5



### Champagnerkühler

champagne bowl  
cubo champañera  
seau à champagne



**außen hochglanzpoliert, innen matt poliert, mit vergoldeten Griffen**

outside mirror polished, inside matt polished, with gold plated handles  
exterior pulido brillante, interior pulido mate  
extérieur brillant, intérieur poli mat

	Ø cm	↑ cm	ltr.
36047	42 / 27	28	20



### Champagnerkühler

champagne bowl  
cubo champañera  
seau à champagne



**hochglanzpoliert**

mirror polished  
pulido brillante  
poli brillant

	Ø cm	↑ cm	ltr.
36045	40,5 / 27,5	22,5	13,5



### Champagnerkühler

champagne bowl  
cubo champañera  
seau à champagne



**hochglanzpoliert, Rand matt poliert**

mirror polished, edge matt polished  
pulido brillante, borde pulido mate  
poli brillant, bord poli mat

	Ø cm	↑ cm	ltr.
36046	45 / 21	23	12



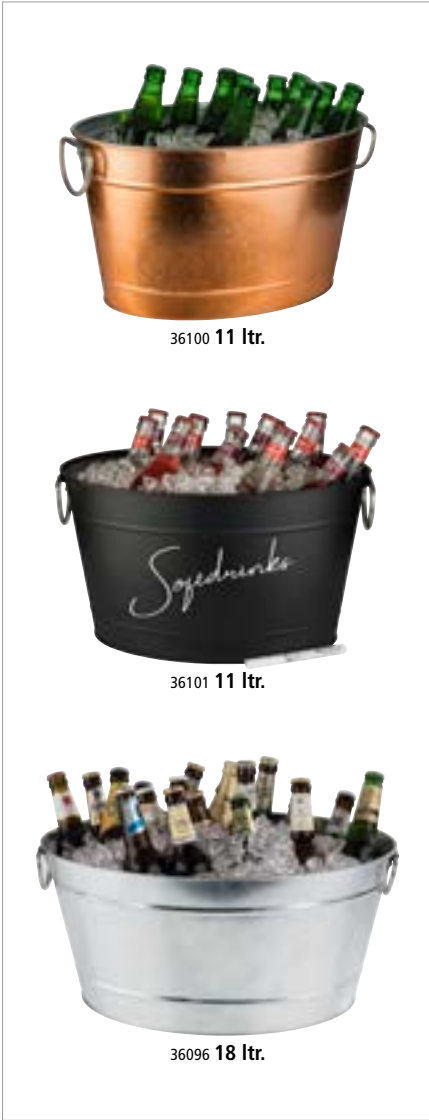

**Getränkewanne „TIN“**

beverage tub  
barreño botellines  
bassine à glace

**Metall verzinkt, mit Kunststoffeinsatz**  
galvanised metal, with plastic insert  
metal galvanizado, con inserto de plástico  
métal galvanisé, avec insert en plastique



	cm	↑ cm	ltr.	Farbe / Colour
36100	40 x 28	22	11	copper-look
36101	40 x 28	22	11	black-metal-look
36095	40 x 28	22	11	metal-look
36096	50 x 23	23	18	metal-look



**mit Kunststoffeinsatz**  
with plastic insert  
con inserto de plástico  
avec insert en plastique



71490

**Kreidestift zum Beschriften** | chalk marker for writing  
S. 304



**Wein- / Sektkühler**

wine / champagne bowl  
cubitera para vino y cava  
seau à vin ou champagne

**glasklar, für bis zu 6 Flaschen geeignet**  
transparent, suitable for up to 6 bottles  
transparente, para máximo 6 botellas  
transparent, maxi 6 bouteilles



	cm	↑ cm	ltr.
36057	47 x 28	23	10



**Wein- / Sektkühler**

wine / champagne bowl  
cubitera para vino y cava  
seau à vin ou champagne

**mit seitlichen Griffen, transparent**  
with lateral handles, transparent  
con asas laterales  
avec poignées latérales



	cm	↑ cm	ltr.
36087	32 x 21,5	24,5	7

## BOTTLE COOLERS



36048

**Wein- / Sektkühler**  
 wine / champagne bowl  
 cubitera para vino y cava  
 seau à vin ou champagne  
**mit 2 seitlichen Eingriffen**  
 with 2 handles on the side  
 con 2 asas  
 avec 2 poignées



	cm	↑ cm	ltr.
36048	35 x 27	25,5	6
36052	27 x 20	21	3



36054

**Wein- / Sektkühler**  
 wine / champagne bowl  
 cubitera para vino y cava  
 seau à vin ou champagne  
**mit 2 seitlichen Eingriffen**  
 with 2 handles on the side  
 con 2 asas  
 avec 2 poignées



	cm	↑ cm	ltr.	Farbe / Colour
36054	35 x 27	25,5	6	■
36053	27 x 20	21,0	3	■



**Wein- / Sektkühler**  
 wine / champagne bowl  
 cubitera para vino y cava  
 seau à vin ou champagne  
**glasklar, für zwei Flaschen**  
 clear, for two bottles  
 transparente, para 2 botellas  
 transparent, pour 2 bouteilles



	cm	↑ cm	ltr.
36056	30,5 x 21,5	26	4





**Flaschenkühler**

bottle cooler  
enfriador de botella  
rafraîchisseur de bouteille

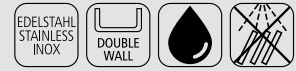

**doppelwandig für beste Isolierung, für 0,7 - 1,5 Liter-Flaschen**

double wall cooler keeps the temperature for a long time, for 0,7 - 1,5 ltr. bottles  
con doble pared para mantener el frio largo tiempo, para botellas de 0,7 - 1,5 ltr.  
double paroi pour une meilleure conservation de la température, pour bouteilles de 0,7 à 1,5 l.

	Ø cm	↑ cm	Farbe / Colour
36125	12 / 10	20	copper red
36126	12 / 10	20	blue
36127	12 / 10	20	black



**Flaschenkühler „COPPER“**

bottle cooler  
enfriador de botella  
rafraîchisseur de bouteille



**Hammerschlag-Optik, doppelwandig für beste Isolierung, für 0,7 - 1,5 Liter-Flaschen**

double wall cooler keeps the temperature for a long time, hammered look, for 0,7 - 1,5 ltr. bottles  
doble pared para mantener el frigo largo tiempo, para botellas de 0,7 - 1,5 ltr.  
double paroi pour une meilleure conservation de la température, pour bouteilles de 0,7 à 1,5 l.

	Ø cm	↑ cm	Farbe / Colour
36074	12 / 10	20	



**Flaschenkühler**

bottle cooler  
enfriador de botella  
rafraîchisseur de bouteille

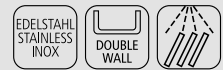

**matt poliert, doppelwandig für beste Isolierung, für 0,7 - 1,5 Liter-Flaschen**

matt polished, double wall cooler keeps the temperature for a long time, for 0,7 - 1,5 ltr. bottles  
pulido mate, doble pared para mantener el frio largo tiempo, para botellas de 0,7 - 1,5 ltr.  
poli mat, double paroi pour une meilleure conservation de la température, pour bouteilles de 0,7 à 1,5 l.

	Ø cm	↑ cm
36030	12 / 10	20



**Flaschenkühler**

bottle cooler  
enfriador de botella  
rafraîchisseur de bouteille

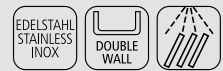

**matt poliert, doppelwandig für beste Isolierung, für 0,7 - 1,5 Liter-Flaschen**

matt polished, double wall cooler keeps the temperature for a long time, for 0,7 - 1,5 ltr. bottles  
pulido mate con doble pared para mantener el frio largo tiempo, para botellas de 0,7 - 1,5 ltr.  
poli mat, double paroi pour une meilleure conservation de la température, pour bouteilles de 0,7 à 1,5 l.

	Ø cm	↑ cm
36038	12,5 / 10	19

## BOTTLE COOLERS



### Flaschenkühler

bottle cooler  
enfriador de botella  
rafraîchisseur de bouteille



**transparent, doppelwandig für beste Isolierung, mit Chromrand**

transparent, double wall cooler keeps the temperature for a long time, with chrome edge  
transpar., doble pared mantiene la temperatura por largo tiempo, borde superior cromado  
transparent, bord chromé brillant, double paroi pour maintien en température

	Ø cm	↑ cm	Farbe / Colour
36032	12 / 10	23	
36034	12 / 10	23	



### Flaschenkühler „PURE“

bottle cooler  
enfriador de botella  
rafraîchisseur de bouteille



**doppelwandig für beste Isolierung, glasklar**

double wall cooler keeps the temperature for a long time, clear  
doble pared mantiene la temperatura por largo tiempo, transparente  
double paroi pour maintien en température, transparent

	Ø cm	↑ cm
36063	13,5 / 10,5	23
36062	13,5 / 10,5	23



### Pitcher

pitcher  
jarra  
pichet



	Ø cm	↑ cm	ltr.
93105	13	21	1,5



**einfaches Eingießen**  
easy pouring

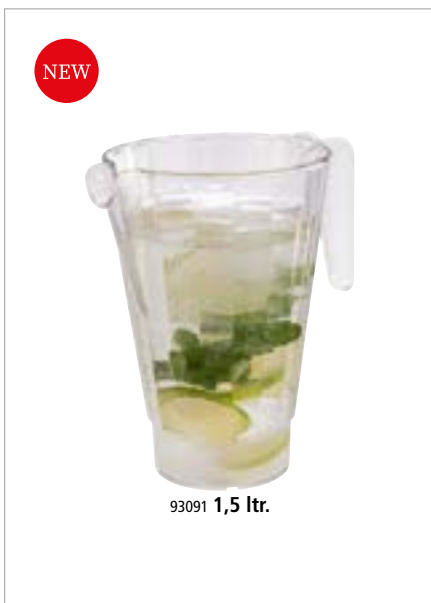

NEW

93091 1,5 ltr.

### Pitcher

pitcher  
jarra  
pichet



	Ø cm	↑ cm	ltr.
93090	12,5	17,5	1,0
93091	13,5	20,0	1,5

**passende Deckel / fitting lids / tapa adecuadas / couvercles appropriées**

	cm	↑ cm	fits to
93092	13,0	1,5	93090
93093	14,0	1,5	93091

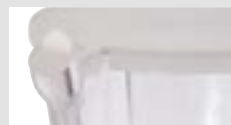

**Deckel mit Klappe**  
lid with flap



**einfaches Eingießen**  
easy pouring



**stapelbar**  
stackable



Flaschenkühler „ELEMENT“

bottle cooler  
enfriador de botella  
rafraîchisseur de bouteille

**Beton, geriffelte Oberfläche, möbelschonende Unterseite**  
concrete, ribbed surface, non-scratching undersurface  
hormigón, superficie ranurada, base anti rayaduras  
béton, surface rainurée, base revêtement antirayures



	Ø cm	↑ cm	Farbe / Colour
36122	13 / 10	19,5	white
36123	13 / 10	19,5	concrete
36124	13 / 10	19,5	green



Oberflächenansicht  
structural view



Präsentationsmöglichkeit  
presentation example



Flaschenkühler „ELEMENT“

bottle cooler  
enfriador de botella  
rafraîchisseur de bouteille

**Beton, möbelschonende Unterseite**  
concrete, non-scratching undersurface  
hormigón, base anti rayaduras  
béton, base revêtement antirayures



	Ø cm	↑ cm	Farbe / Colour
36104	12 / 10	19	rose
36105	12 / 10	19	green



Flaschenkühler „ELEMENT“

bottle cooler  
enfriador de botella  
rafraîchisseur de bouteille

**Beton, möbelschonende Unterseite**  
concrete, non-scratching undersurface  
hormigón, base anti rayaduras  
béton, base revêtement antirayures



	Ø cm	↑ cm	Farbe / Colour
36090	12 / 10	19	concrete
36099	12 / 10	19	black

**NEW**



**Flaschenkühler „BIG BOWL“**

bottle cooler  
enfriador de botella  
rafraîchisseur de bouteille



**gehämmerte Oberfläche, innen matt poliert, herausnehmbarer Tropfeinsatz**

hammered surface, inside matt polished, removable drip tray  
superficie martillada, interior pulido mate, bandeja de goteo extraíble  
surface martelée, intérieur poli mat, bac d'égouttage amovible

	Ø cm	↑ cm	ltr.
36130	37	23	8



herausnehmbarer  
Tropfeinsatz  
removable drip tray



Präsentationsmöglichkeit  
presentation example



**Kühlmanschette „CHAMPAGNE“**

cool collar  
funda de frío  
housse isotherme



**für Sekt- / Champagnerflaschen, einfach im Gefrierfach einfrieren, komplette Flasche wird in 5 Min. auf angenehme Trinktemperatur gekühlt, außen reißfestes Stoffgewebe, innen Kunststoff mit Kühlgel gefüllt, unbegrenzt wiederverwendbar**

for bottles of champagne, simply to freeze in the freezer, complete bottles will be cooled down in only 5 minutes, tearproof cloth outside, plastic filled with gel inside, unlimited reusable  
para botellas de cava o champán simplemente congelándola en el congelador, la botella entera se enfriará en 5 minutos, funda de plástico muy robusta, rellena con un gel congelante reutilizable ilimitadamente

pour bouteilles de vin ou champagne, la housse est préalablement stockée au congélateur, où elle accumule le froid, ensuite elle refroidit une bouteille en quelques minutes, plastique résistant, contient un liquide congelant, à réutiliser de façon illimitée

	Ø cm	↑ cm
36075	11	18



**Weinflaschenhalter**

winebottle-stand  
soporte para botella de vino  
porte-bouteille



	cm	↑ cm
30333	22 x 6	20,5

# BEVERAGE DISPENSERS



NEW

7 ltr.

10853

## Getränkespender „INDUSTRIAL“

beverage dispenser  
dispensador de bebidas  
distributeur de boissons

Black  
&  
beautiful

GLAS  
GLASS

EDELSTAHL  
STAINLESS  
INOX

METALL

SILIKON  
SILICON

NON  
SLIP  
FEET

Behälter aus Glas, Zapfhahn aus Edelstahl, Fuß und Deckel aus Metall, schwarz, Antirutschmatte aus Silikon

glass container, stainless steel tap, base and lid in black metal, silicone non-slip mat  
recipiente de vidrio, grifo de acero inoxidable, base y tapa de metal negro, tapete antideslizante de silicona

réceptien en verre, robinet en acier inox, pied et couvercle en métal noir, tapis antidérapant en silicone

	Ø cm	↑ cm	ltr.	
10450	20	45	7	inkl. Gestell / incl. stand



Antirutschmatte aus Silikon  
Antirutschmatte aus Silikon



NEW

7 ltr.

## Getränkespender „URBAN“

beverage dispenser  
dispensador de bebidas  
distributeur de boissons

Black  
&  
beautiful

GLAS  
GLASS

EDELSTAHL  
STAINLESS  
INOX

METALL

SILIKON  
SILICON

Behälter aus Glas, Zapfhahn aus Edelstahl, Fuß und Deckel aus Metall, schwarz, Antirutschmatte aus Silikon

glass container, stainless steel tap, base and lid in black metal, silicone non-slip mat  
recipiente de vidrio, grifo de acero inoxidable, base y tapa de metal negro, tapete antideslizante de silicona

réceptien en verre, robinet en acier inox, pied et couvercle en métal noir, tapis antidérapant en silicone

	Ø cm	↑ cm	ltr.	
10451	22	45	7	inkl. Gestell / incl. stand



Antirutschmatte aus Silikon  
Antirutschmatte aus Silikon



## Eiswasserröhre

ice cube cooling tube  
tubo enfriador para cubitos  
tube pour glaçons

PP  
POLYPROP.



	Ø cm	↑ cm	passend für Getränkenspender / fits to drink dispenser
10849	11	24	10400, 10403, 10450, 10451, 10855

## BEVERAGE DISPENSERS



7 ltr.

### Getränkespender „ELEMENT“

beverage dispenser  
dispensador de bebidas  
distributeur de boissons



Behälter aus Glas, Zapfhahn aus Edelstahl, Fuß und Deckel aus Beton

glass container, stainless steel tap, stand and lid made of concrete  
recipiente de vidrio, grifo de acero inoxidable, soporte y tapa de hormigón  
récipient en verre, robinet en acier inox, support et couvercle en béton

	Ø cm	↑ cm	ltr.	
10400	22	45	7	inkl. Gestell / incl. stand



7 ltr.

### Getränkespender „OLD FASHIONED“

beverage dispenser  
dispensador de bebidas  
distributeur de boissons



Behälter aus Glas, Zapfhahn aus Edelstahl, Gestell schwarz

glass container, stainless steel tap, black stand  
recipiente de vidrio, grifo de acero inoxidable, soporte negro  
récipient en verre, robinet en acier inox, support noir

	Ø cm	↑ cm	ltr.	
10409	27	50,5	7	inkl. Gestell / incl. stand

Ersatz-Gestell / stand / soporte de recambio / support de remplacement

	Ø cm	↑ cm	
10410	27	31,5	

Ersatz-Glas / replacement glass / cristal de recambio / vitre de rechange

	Ø cm	↑ cm	ltr.
10411	19	36,5	7

Ersatz-Zapfhahn 10409 / replacement tap for 10409

10718



7 ltr.

### Getränkespender „ASIA“

beverage dispenser  
dispensador de bebidas  
distributeur de boissons



Behälter aus Glas, Zapfhahn aus Edelstahl, Fuß und Deckel aus Holz

glass container, stainless steel tap, wooden stand and lid  
recipiente de vidrio, grifo de acero inoxidable, soporte y tapa de madera  
récipient en verre, robinet en acier inox, support et couvercle en bois

	Ø cm	↑ cm	ltr.	
10403	24,5	45,5	7	inkl. Gestell / incl. stand

Ersatz-Fuß / base / soporte de recambio / support de remplacement

	Ø cm	↑ cm	
10404	24,5	15	

Ersatz-Deckel / replacement lid / tapa de recambio / couvercle de rechange

	Ø cm	↑ cm	
10405	14,0	5	



10853

### Tropfenschale, 2-teilig

drip tray, 2 pcs.  
aros anti-goteo, set de 2  
anneaux coupe-gouttes, set de 2



	Ø cm	↑ cm	Farbe / Colour
10851	9,5	1,5	White
10853	9,5	1,5	Black



LINEA



UNZERBRECHLICH | UNBREAKABLE



Trinkbecher „LINEA“

drinking cups

vasos

gobelets



Die elegant facettierte Bechergläser LINEA lassen sich vielseitig im Bar-, Club-, Pool-, und Buffetbereich verwenden. Sowohl die transparenten als auch die farbigen Modelle setzen in jedem Ambiente edle Akzente. Dank ihrer perfekten Stapelbarkeit werden sie platzsparend aufbewahrt und transportiert.

The elegantly faceted tumbler glasses LINEA can be used in a variety of ways in the bar, club, pool and buffet areas. Both the transparent and coloured models set elegant accents in any ambience. Thanks to their perfect stackability, they are space-saving to store and transport.

Los vasos LINEA, elegantemente facetados, pueden utilizarse de diversas maneras en el bar, el club, la piscina y el buffet. Tanto los modelos transparentes como los de color ponen elegantes acentos en cualquier ambiente. Gracias a su perfecta apilabilidad, ahorran espacio para su almacenamiento y transporte.

Les verres LINEA élégamment facetés peuvent être utilisés de manière polyvalente dans les bars, les clubs, les piscines et les buffets. Les modèles transparents et colorés apportent une touche de noblesse dans chaque ambiance. Grâce à leur parfaite empilabilité, ils se rangent et se transportent avec un minimum d'encombrement.

	Ø cm	↑ cm	litr.	VE	Farbe / Colour		
10560	6,5	8,0	0,15	48	—	—	
10561	8,5	8,0	0,22	48	—	—	
10562	8,5	10,0	0,30	48	—	—	
10563	8,5	12,0	0,40	48	—	—	
10564	8,5	15,0	0,50	48	—	—	
10565	6,5	8,0	0,15	48		french grey	
10566	8,5	8,0	0,22	48		french grey	
10567	8,5	10,0	0,30	48		french grey	
10568	8,5	12,0	0,40	48		french grey	
10569	8,5	15,0	0,50	48		french grey	
10570	6,5	8,0	0,15	48		light green	
10571	8,5	8,0	0,22	48		light green	
10572	8,5	10,0	0,30	48		light green	
10573	8,5	12,0	0,40	48		light green	
10574	8,5	15,0	0,50	48		light green	
10575	6,5	8,0	0,15	48		light pink	
10576	8,5	8,0	0,22	48		light pink	
10577	8,5	10,0	0,30	48		light pink	
10578	8,5	12,0	0,40	48		light pink	
10579	8,5	15,0	0,50	48		light pink	
10585		6,5	8,0	0,15	48		light blue
10586		8,5	8,0	0,22	48		light blue
10587		8,5	10,0	0,30	48		light blue
10588		8,5	12,0	0,40	48		light blue
10589		8,5	15,0	0,50	48		light blue



alle Größen  
ineinander stapelbar  
all sizes stackable

# CRYSTAL



UNZERBRECHLICH | UNBREAKABLE

5 SIZES

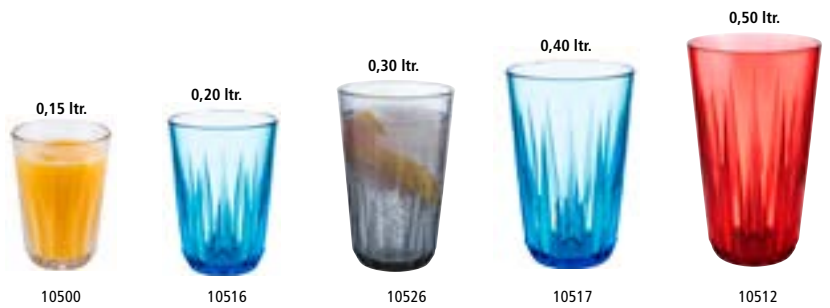

Trinkbecher „CRYSTAL“  
drinking cups  
vasos  
gobelets



Kristallglas-Optik, vielseitig einsetzbar, robustes, unzerbrechliches Material, ideal in sensiblen Bereichen wie Pool, Spa, Beach und Wellness einzusetzen, BPA-frei  
crystal-glass-look, can be used in versatile ways, a solide and unbreakable material, ideal to be used at pool, spa, beach and wellness areas, bpa-free  
aspecto vidrio, se pueden utilizar de muchas maneras diferentes, material sólido e irrompible, ideal para el uso en áreas como piscina, spa, playa y bienestar, libre de BPA  
ressemble à un verre de cristal, peuvent être utilisés de différentes façons, matériau robuste et incassable, idéal pour une utilisation dans des zones comme la piscine, le spa, la plage et le bien-être, sans BPA

	Ø cm	↑ cm	ltr.	VE	Farbe / Colour
10500	7,0	9,5	0,15	48	—
10503	7,5	11,0	0,20	48	—
10501	8,0	12,5	0,30	48	—
10504	8,5	14,0	0,40	48	—
10502	9,0	15,5	0,50	48	—

	Ø cm	↑ cm	ltr.	VE	Farbe / Colour
10513	7,0	9,5	0,15	48	■
10516	7,5	11,0	0,20	48	■
10514	8,0	12,5	0,30	48	■
10517	8,5	14,0	0,40	48	■
10515	9,0	15,5	0,50	48	■



UNZERBRECHLICH  
UNBREAKABLE



## Made in Germany

Auch die inneren Werte können sich sehen lassen. Der Trinkbecher „CRYSTAL“ wird ressourcenschonend ausschließlich in Deutschland produziert. Das Material ist zu 100% recycelbar.





	Ø cm	↑ cm	ltr.	VE	Farbe / Colour
10510	7,0	9,5	0,15	48	
10511	8,0	12,5	0,30	48	
10512	9,0	15,5	0,50	48	
	Ø cm	↑ cm	ltr.	VE	Farbe / Colour
10525	7,0	9,5	0,15	48	
10526	8,0	12,5	0,30	48	
10527	9,0	15,5	0,50	48	
	Ø cm	↑ cm	ltr.	VE	Farbe / Colour
10528	7,0	9,5	0,15	48	
10529	8,0	12,5	0,30	48	
10530	9,0	15,5	0,50	48	
	Ø cm	↑ cm	ltr.	VE	Farbe / Colour
10531	7,0	9,5	0,15	48	
10532	8,0	12,5	0,30	48	
10533	9,0	15,5	0,50	48	
	Ø cm	↑ cm	ltr.	VE	Farbe / Colour
10534	7,0	9,5	0,15	48	
10535	8,0	12,5	0,30	48	
10536	9,0	15,5	0,50	48	

**UNZERBRECHLICH**  
UNBREAKABLE

**Farbe grau**  
colour light grey

10509

stapelbar  
stackable

**Trinkglas „BEACH“**  
drinking glass  
vaso  
verre

**vielseitig einsetzbar, robustes, unzerbrechliches Material, BPA-frei**  
can be used in versatile ways, a solide and unbreakable material, bpa-free  
se pueden utilizar de muchas maneras diferentes, material sólido e irrompible, libre de BPA  
peuvent être utilisés de différentes façons, matériau robuste et incassable, sans BPA

	Ø cm	↑ cm	ltr.	VE	Farbe / Colour
10509	8,5	13,5	0,30	48	
10505	8,5	13,5	0,30	48	–

# MOSCOW MULE



## Flaschenkühler „MOSCOW MULE“

bottle cooler  
enfriador de botellas  
rafraîchisseur de bouteilles

**Edelstahl-Flaschenkühler, Antik-Kupfer-Look**  
stainless steel cooler, copper antique look  
enfriador de acero inoxidable, cobre estilo antigua  
rafraîchisseur en acier inox, cuivre style antique



	Ø cm	↑ cm	ltr.	Farbe / Colour
93330	20	21	5	 copper-antique-hammered



## Becher „MOSCOW MULE“, 2er-Set

barrel copper mug, 2 pcs.  
taza, set de 2  
gobelet, set de 2

**Edelstahlbecher, Antik-Kupfer-Look**  
stainless steel cup, copper antique look  
taza de acero inoxidable, cobre estilo antiguo  
gobelet en acier inox, cuivre style antique



	Ø cm	↑ cm	ltr.	Farbe / Colour
93367	9	10	0,5	 copper-antique-hammered



## Becher „MOSCOW MULE“

barrel mug  
taza  
gobelet

**Edelstahlbecher, Antik-Edelstahl-Look**  
stainless steel cup, stainless steel antique look  
taza de acero inoxidable, acero estilo antiguo  
gobelet en acier inox, acier style antique



	Ø cm	↑ cm	ltr.	Farbe / Colour
93346	9	10	0,5	 stainless-antique-hammered

**Becher „MOSCOW MULE“**

barrel mug

taza

gobelet

**Edelstahlbecher, Antik-Edelstahl-Look**

stainless steel cup, stainless antique look

taza de acero inoxidable, acero estilo antiguo

gobelet en acier inox, acier style antique



	Ø cm	↑ cm	ltr.	Farbe / Colour	
93345	9	9	0,45		stainless-antique

**Becher „MOSCOW MULE“**

barrel copper mug

taza

gobelet

**Edelstahlbecher, Antik-Kupfer-Look**

stainless steel cup, copper antique look

taza de acero inoxidable, cobre estilo antiguo

gobelet en acier inox, cuivre style antique

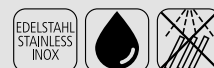

	Ø cm	↑ cm	ltr.	Farbe / Colour	
93322	9	9	0,45		copper-antique

**Becher „MOSCOW MULE“**

barrel copper mug

taza

gobelet

**Edelstahlbecher, Kupfer-Look, hochglanzpoliert**

stainless steel cup, copper look, mirror polished

taza de acero inoxidable, estilo cobre, pulido brillante

gobelet en acier inox, aspect cuivre, poli brillant



	Ø cm	↑ cm	ltr.	Farbe / Colour	
93310	9	9	0,45		copper-look

**Becher „MOSCOW MULE“**

barrel copper mug

taza

gobelet

**Edelstahlbecher, Kupfer-Look, hochglanzpoliert**

stainless steel cup, copper look, mirror polished

taza de acero inoxidable, estilo cobre, pulido brillante

gobelet en acier inox, aspect cuivre, poli brillant



	Ø cm	↑ cm	ltr.	Farbe / Colour	
93311	9	10	0,50		copper-hammered

**Becher „MOSCOW MULE“**

barrel copper mug

taza

gobelet

**Edelstahlbecher, Antik-Kupfer-Look**

stainless steel cup, copper look

taza de acero inoxidable, cobre estilo antiguo

gobelet en acier inox, cuivre style antique

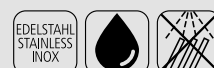

	Ø cm	↑ cm	ltr.	Farbe / Colour	
93323	9	10	0,50		copper-antique-hammered

## MOSCOW MULE



### Becher „MOSCOW MULE“

barrel mug  
taza  
gobelet

**Edelstahlbecher, Antik-Edelstahl-Look**  
stainless steel cup, stainless antique look  
taza de acero inoxidable, acero estilo antiguo  
gobelet en acier inox, acier style antique



	Ø cm	↑ cm	litr.	Farbe / Colour	
93333	9,5	10	0,50		stainless-antique



### Becher „MOSCOW MULE“

barrel copper mug  
taza  
gobelet

**Edelstahlbecher, Antik-Kupfer-Look**  
stainless steel cup, copper antique look  
taza de acero inoxidable, cobre estilo antiguo  
gobelet en acier inox, cuivre style antique



	Ø cm	↑ cm	litr.	Farbe / Colour	
93331	9,5	10	0,50		copper-antique



### Becher „MOSCOW MULE“

barrel copper mug  
taza  
gobelet

**Edelstahlbecher, Kupfer-Look, hochglanzpoliert**  
stainless steel cup, copper look, mirror polished  
taza de acero inoxidable, estilo cobre, pulido brillante  
gobelet en acier inox, aspect cuivre, poli brillant



	Ø cm	↑ cm	litr.	Farbe / Colour	
93332	9,5	10	0,50		copper-look

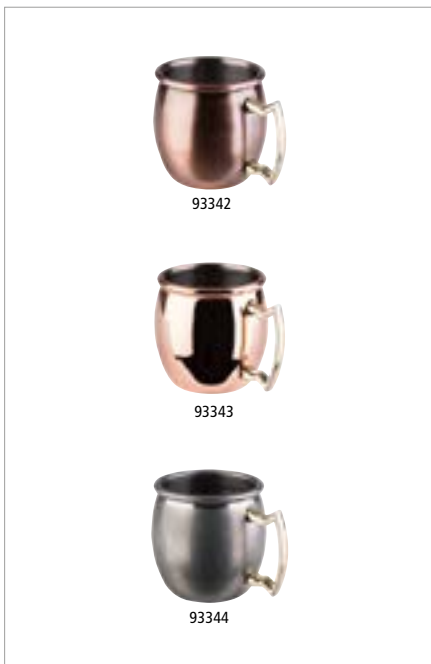

### Becher „MINI SHOT“, 4er-Set

barrel mug 4 pcs.  
taza, set de 4  
gobelet, set de 4



	Ø cm	↑ cm	litr.	Farbe / Colour		pcs.
93342	4,5	4,5	0,05		copper-antique	4
93343	4,5	4,5	0,05		copper-look	4
93344	4,5	4,5	0,05		stainless-antique	4





**Becher „COOL“**

barrel mug  
taza  
gobelet



**Edelstahlbecher, Kupfer-Look, hochglanzpoliert**  
stainless steel cup, copper look, mirror polished  
taza de acero inoxidable, estilo cobre, pulido brillante  
gobelet en acier inox, aspect cuivre, poli brillant

	Ø cm	↑ cm	ltr.	Farbe / Colour	
93371	7,5	10,5	0,35		copper-look



**Becher „COOL“**

barrel mug  
taza  
gobelet



**Edelstahlbecher, Gunmetal-Look, hochglanzpoliert**  
stainless steel cup, gunmetal look, mirror polished  
taza de acero inoxidable, estilo gunmetal, pulido brillante  
gobelet en acier inox, aspect gunmetal, poli brillant

	Ø cm	↑ cm	ltr.	Farbe / Colour	
93372	7,5	10,5	0,35		gunmetal-look



**Becher „COOL“**

barrel mug  
taza  
gobelet



**Edelstahlbecher, Antik-Edelstahl-Look**  
stainless steel cup, stainless antique look  
taza de acero inoxidable, acero estilo antiguo  
gobelet en acier inox, acier style antique

	Ø cm	↑ cm	ltr.	Farbe / Colour	
93373	7,5	10,5	0,35		stainless-antique

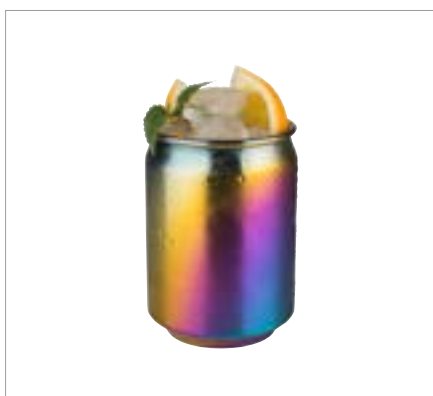

**Becher „COOL“**

barrel mug  
taza  
gobelet



**Edelstahlbecher, Regenbogen-Look**  
stainless steel cup, rainbow look  
taza de acero inoxidable, estilo arco iris  
gobelet en acier inox, look arc-en-ciel

	Ø cm	↑ cm	ltr.	Farbe / Colour	
93374	7,5	10,5	0,35		rainbow-look



**Becher „BEER MUG“**

barrel mug  
taza  
gobelet



	Ø cm	↑ cm	ltr.	Farbe / Colour	
93364	8,5	13	0,50		copper-antique
93365	8,5	13	0,50		stainless-antique

93364

93365

## PINEAPPLE MUGS



mit Deckel  
with lid  
ohne Strohalm  
without straw

### Becher „PINEAPPLE“

barrel mug  
taza  
gobelet

Glasbecher mit Edelstahl Deckel

glass cup with stainless steel lid

taza de cristal con tapa en acero inoxidable

gobelet en verre avec couvercle en acier inox



	Ø cm	↑ cm	ltr.
93375	8,5	17,5	0,35



mit Deckel  
with lid  
ohne Strohalm  
without straw

### Becher „PINEAPPLE“

barrel mug  
taza  
gobelet

Edelstahlbecher, Kupfer-Look

stainless steel cup, copper look

taza de acero inoxidable, cobre

gobelet en acier inox, cuivre



	Ø cm	↑ cm	ltr.	Farbe / Colour
93334	9	19	0,5	 copper-look



mit Deckel  
with lid  
ohne Strohalm  
without straw

### Becher „PINEAPPLE“

barrel mug  
taza  
gobelet

Edelstahlbecher, Gold-Look

stainless steel cup, gold look

taza de acero inoxidable, dorada

gobelet en acier inox, doré



	Ø cm	↑ cm	ltr.	Farbe / Colour
93335	9	19	0,5	 gold-look



93399

93400

### Gläserchiene

glass rack  
rack de copas  
rack porte-verres



aus 6 mm Draht, Metall verchromt, Wand- und Deckenmontage möglich

6 mm chrome plated wire, can be mounted under a shelf or on the wall

alambre cromado de 6 mm, puede instalarse bajo una estantería o en la pared

fil chromé de 6 mm, à installer sous une étagère ou contre un mur



	cm	↑ cm	for glasses	Farbe / Colour
93398	29,5 x 32	6	12	 chrome
93399	29,5 x 32	6	12	 black
93400	45,0 x 32	6	20	 chrome



# JULEP MUGS



## Becher „JULEP MUG“ barrel mug taza gobelet



	Ø cm	↑ cm	ltr.	Farbe / Colour
93336	8	11,5	0,40	copper-antique-hammered
93337	8	11,5	0,40	copper-hammered
93338	8	11,5	0,40	stainless-antique-hammered



## Becher „JULEP MUG“ barrel mug taza gobelet



	Ø cm	↑ cm	ltr.	Farbe / Colour
93327	8,5	10	0,35	copper-antique
93328	8,5	10	0,35	copper-look
93329	8,5	10	0,35	stainless



## Snackspender snack dispenser dispensador de snacks distributeur de snacks



**Behälter aus Glas, Schraubdeckel aus Edelstahl, Öffnung oval 3,5 x 2,5 cm**  
glass container, stainless steel screw cap, opening oval 3,5 x 2,5 cm  
recipiente de cristal, tapón de rosca de acero inoxidable, apertura ovalada 3,5 x 2,5 cm  
récipient en verre, couvercle à visser en acier inox, ouverture ovale 3,5 x 2,5 cm

	Ø cm	↑ cm	ltr.	Farbe / Colour
40516	8,5	15,5	0,35	gold-look
40517	8,5	15,5	0,35	gunmetal-look



# MINI FEUERZANGEN-SETS

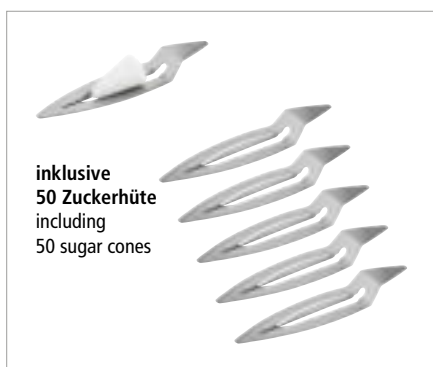

inklusive  
50 Zuckerhüte  
including  
50 sugar cones

## Mini Feuerzangen-Set I

mini fire punch bowl set  
mini set para ponche caliente  
mini set pour punch



bestehend aus: 6 Mini Feuerzangen / 50 Mini Zuckerhüte

consisting of: 6 mini fire tongs / 50 mini sugar cones  
compuesto por: 6 mini pinzas para el fuego / 50 mini conos de azúcar  
composé de: 6 mini-pinces à feu / 50 mini-cônes à sucre

	cm	↑ cm
65070	14,5 x 3,5	1,5



inklusive 50 Zuckerhüte  
including 50 sugar cones

2 Stk.  
2 pcs.

2 Stk.  
2 pcs.

## Mini Feuerzangen-Set II

mini fire punch bowl set  
mini set para ponche caliente  
mini set pour punch



bestehend aus:

2 Edelstahlbecher, Kupfer-Look / 2 Mini Feuerzangen / 50 Mini Zuckerhüte

consisting of:  
2 stainless steel cups, copper look / 2 mini fire tongs / 50 mini sugar cones  
compuesto por:  
2 tazas de acero inoxidable, cobre / 2 mini pinzas para el fuego / 50 mini conos de azúcar  
composé de:  
2 tasses en acier inox, cuivre / 2 mini-pinces à feu / 50 mini-cônes à sucre

	∅ cm	↑ cm	litr.
65071	9	9	0,45

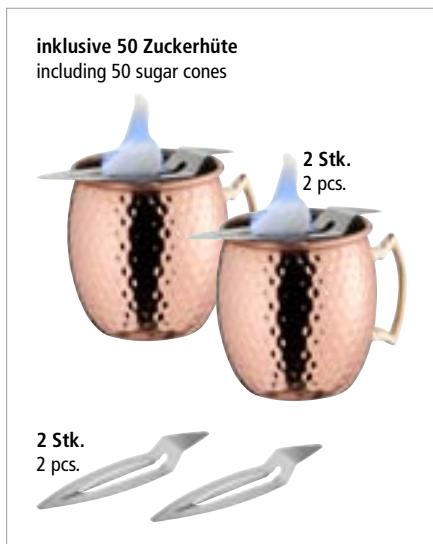

inklusive 50 Zuckerhüte  
including 50 sugar cones

2 Stk.  
2 pcs.

2 Stk.  
2 pcs.

## Mini Feuerzangen-Set II

mini fire punch bowl set  
mini set para ponche caliente  
mini set pour punch



bestehend aus:

2 Edelstahlbecher, Kupfer-Look / 2 Mini Feuerzangen / 50 Mini Zuckerhüte

consisting of:  
2 stainless steel cups, copper look / 2 mini fire tongs / 50 mini sugar cones  
compuesto por:  
2 tazas de acero inoxidable, cobre / 2 mini pinzas para el fuego / 50 mini conos de azúcar  
composé de:  
2 tasses en acier inox, cuivre / 2 mini-pinces à feu / 50 mini-cônes à sucre

	∅ cm	↑ cm	litr.
65072	9	10	0,5

## SHAKERS



## Shaker „CLASSIC“

shaker  
coctelera  
shaker



3-teiliges Set: Edelstahlbecher, Siebaufsatz, Deckel, hochglanzpoliert

3 pieces: stainless steel mug, strainer, lid, mirror polished

set de 3: taza de acero inoxidable, colador, tapa, pulido brillante

set de 3: gobelet en acier inox, tamis, couvercle, poli brillant

	Ø cm	↑ cm	ltr.
36010	8,5	20	0,5
36011	9,0	23	0,7



## Shaker „CLASSIC“

shaker  
coctelera  
shaker



3-teiliges Set: Edelstahlbecher, Siebaufsatz, Deckel, Kupfer-Look, hochglanzpoliert

3 pieces: stainless steel mug, strainer, lid, copper look, mirror polished

set de 3: taza de acero inoxidable, colador, tapa, cobre, pulido brillante

set de 3: gobelet en acier inox, tamis, couvercle, cuivre, poli brillant

	Ø cm	↑ cm	ltr.	Farbe / Colour
93211	8,5	20	0,5	copper-look
93212	9,0	23	0,7	copper-look



## Shaker „CLASSIC“

shaker  
coctelera  
shaker



3-teiliges Set: Edelstahlbecher, Siebaufsatz, Deckel

3 pieces: stainless steel mug, strainer, lid

set de 3: taza de acero inoxidable, colador, tapa

set de 3: gobelet en acier inox, tamis, couvercle

	Ø cm	↑ cm	ltr.	Farbe / Colour
93366	9,0	23	0,7	stainless-antique
93326	9,0	23	0,7	copper-antique

## SHAKERS



### Parisian Shaker

shaker  
coctelera  
shaker



**2-teiliges Set, Edelstahlbecher, mattiert**

2 pieces, stainless steel cup, matt polished  
set de 2, taza de acero, pulido mate  
set de 2, gobelet en acier, poli mat

	Ø cm	↑ cm	ltr.
93179	9,5	24	0,7



### Boston Shaker

boston shaker  
coctelera boston  
shaker boston



**2-teiliges Set: Becher, 700 ml + Glas, 400 ml**

2 pcs.: beaker, 700 ml + glass, 400 ml  
set de 2: vaso coctelero, 700 ml+ vaso vidrio 400 ml  
set de 2: bol mélangeur, 700 ml + bol en verre 400 ml

	Ø cm	↑ cm	ltr.	Farbe / Colour
93140	9	30	0,7 / 0,4	stainless-steel
93350	9	30	0,7 / 0,4	stainless-antique
93325	9	30	0,7 / 0,4	copper-antique
93201	9	30	0,7 / 0,4	copper-look

Ersatzglas / spare glass / vaso de recambio / verre de rechange

	Ø cm	↑ cm	ltr.
93138	8,5	14,5	0,4



### Boston Shaker

boston shaker  
coctelera boston  
shaker boston



**2-teiliges Set: Becher, 700 ml, gummiert, rutschfest + Glas, 400 ml**

2 pcs.: beaker, 700 ml, rubberized, anti-slip + glass, 400 ml  
set de 2: vaso coctelero con goma exterior 700 ml + vaso de vidrio 400 ml  
set de 2: bol mélangeur inox extérieur plastifié couleur 700 ml + bol en verre 400 ml

	Ø cm	↑ cm	ltr.	Farbe / Colour
93139	9	30	0,7	

Ersatzglas / spare glass / vaso de recambio / verre de rechange

	Ø cm	↑ cm	ltr.
93138	8,5	14,5	0,4

# JIGGERS



**Barmaß**  
jigger  
medidor jigger  
mesure double jigger



**schnelles und genaues Abmessen von Spirituosen, mit Füllstrich**  
quick and exact measuring of spirits, with fill line  
medida rápida y exacta de licores, con línea de llenado  
mesure exact et rapide des spiritueux, avec ligne de remplissage

	Ø cm	↑ cm	ltr.	Farbe / Colour	
93351	4,5	9	2 / 4		stainless-steel-polished
93354	4,5	9	2 / 4		stainless-antique



**Barmaß**  
jigger  
medidor jigger  
mesure double jigger



**schnelles und genaues Abmessen von Spirituosen, mit Füllstrich**  
quick and exact measuring of spirits, with fill line  
medida rápida y exacta de licores, con línea de llenado  
mesure exact et rapide des spiritueux, avec ligne de remplissage

	Ø cm	↑ cm	ltr.	Farbe / Colour	
93353	4,5	9	2 / 4		copper-look
93352	4,5	9	2 / 4		copper-antique



**Barmaß**  
jigger  
medidor jigger  
mesure double jigger



**schnelles und genaues Abmessen von Spirituosen, mit Füllstrich**  
quick and exact measuring of spirits, with fill line  
medida rápida y exacta de licores, con línea de llenado  
mesure exact et rapide des spiritueux, avec ligne de remplissage

	Ø cm	↑ cm	ltr.	Farbe / Colour	
93164	4,5	9	1,5 / 2,5 / 3,5 / 5		stainless-steel-polished
93355	4,0	11	1,5 / 2,5 / 3,5 / 5		stainless-antique



**Barmaß**  
jigger  
medidor jigger  
mesure double jigger



**schnelles und genaues Abmessen von Spirituosen, mit Füllstrich**  
quick and exact measuring of spirits, with fill line  
medida rápida y exacta de licores, con línea de llenado  
mesure exact et rapide des spiritueux, avec ligne de remplissage

	Ø cm	↑ cm	ltr.	Farbe / Colour	
93165	4,5	9	1,5 / 2,5 / 3,5 / 5		copper-look
93324	4,0	11	1,5 / 2,5 / 3,5 / 5		copper-antique

# JIGGERS



**Barmaß**  
jigger  
medidor jigger  
mesure double jigger



hochglanzpoliert, schnelles und genaues Abmessen von Spirituosen, mit Füllstrich  
mirror polished, quick and exact measuring of spirits, with fill line  
pulido brillante, medida rápida y exacta de licores, con línea de llenado  
poli miroir, mesure exact et rapide des spiritueux, avec ligne de remplissage

	∅ cm	↑ cm	cl.
93356	5	9	1 / 1,5 / 2 / 3 / 4 / 6



**Barmaß**  
jigger  
medidor jigger  
mesure double jigger



hochglanzpoliert, schnelles und genaues Abmessen von Spirituosen, mit Füllstrich  
mirror polished, quick and exact measuring of spirits, with fill line  
pulido brillante, medida rápida y exacta de licores, con línea de llenado  
poli miroir, mesure exact et rapide des spiritueux, avec ligne de remplissage

	∅ cm	↑ cm	cl.
93357	3,5	7,5	3 / 5



**Barmaß**  
jigger  
medidor jigger  
mesure double jigger



hochglanzpoliert, schnelles und genaues Abmessen von Spirituosen, mit Füllstrich  
mirror polished, quick and exact measuring of spirits, with fill line  
pulido brillante, medida rápida y exacta de licores, con línea de llenado  
poli miroir, mesure exact et rapide des spiritueux, avec ligne de remplissage

	∅ cm	↑ cm	cl
93121	4,0 / 3,5	8,5	2 / 4
93112	4,5 / 4,0	8,5	2,5 / 5



**Barmaß**  
jigger  
medidor jigger  
mesure double jigger



hochglanzpoliert, schnelles und genaues Abmessen von Spirituosen, mit Füllstrich  
mirror polished, quick and exact measuring of spirits, with fill line  
pulido brillante, medida rápida y exacta de licores, con línea de llenado  
poli miroir, mesure exact et rapide des spiritueux, avec ligne de remplissage

	∅ cm	↑ cm	cl
93120	4,5 / 3,5	7,0	2 / 4



**Barmaß**  
jigger  
medidor jigger  
mesure double jigger



hochglanzpoliert, schnelles und genaues Abmessen von Spirituosen, mit Füllstrich  
mirror polished, quick and exact measuring of spirits, with fill line  
pulido brillante, medida rápida y exacta de licores, con línea de llenado  
poli miroir, mesure exact et rapide des spiritueux, avec ligne de remplissage

	∅ cm	↑ cm	cl
93116	6 / 5	6	2 / 4

# BAR SPOONS

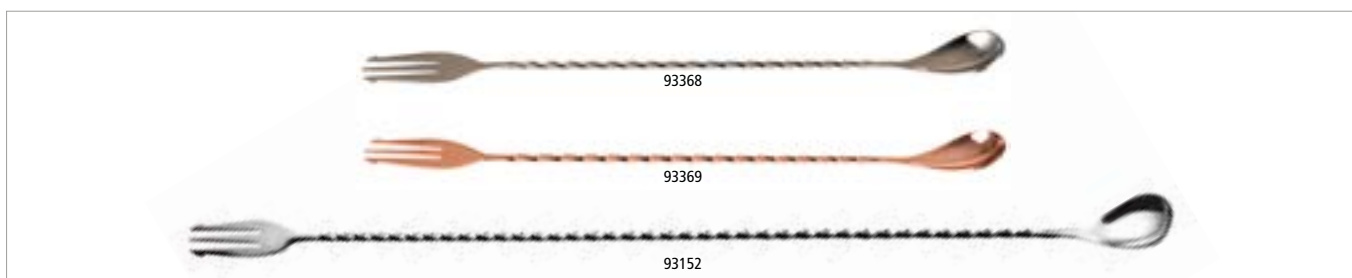

**Barlöffel / -gabel**  
bar spoon  
cucharilla de cóctel trident  
cuillère de bar trident



	→ cm	Farbe / Colour	
93368	30		stainless steel
93369	30		copper-look
93152	50		stainless steel

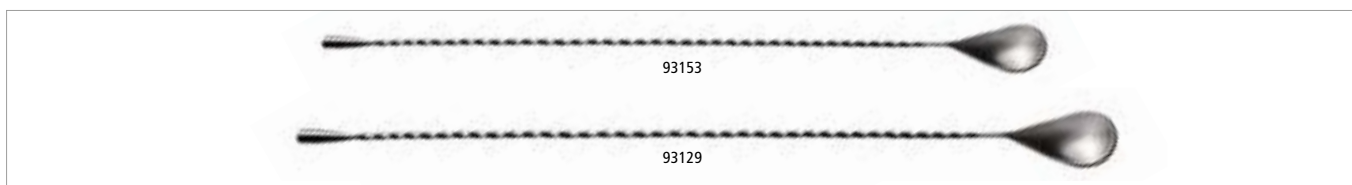

**Barlöffel**  
bar spoon  
cucharilla de cóctel  
cuillère à cocktail



	→ cm	Farbe / Colour	
93153	40		stainless steel
93129	44		stainless steel

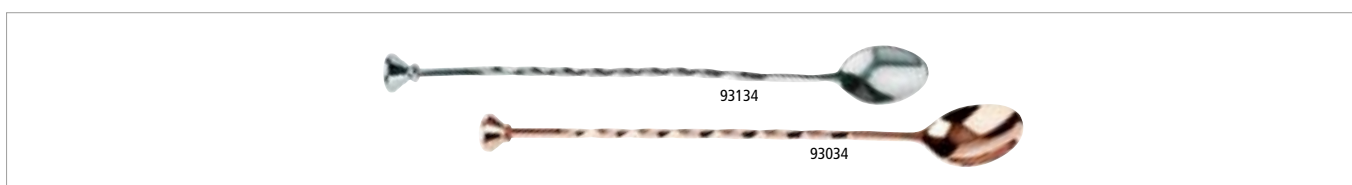

**Barlöffel**  
bar spoon  
cucharilla de cóctel  
cuillère à cocktail



	→ cm	Farbe / Colour	
93134	27		stainless steel
93034	27		copper-look



# BAR STRAINERS



## Barsieb

bar strainer  
colador de cóctel  
tamis cocktail



Spiralfeder hält Eiswürfel beim Abseihen zurück, Feder kann zur Reinigung entnommen werden, passend für alle Gläser und Shaker

coil spring keeps ice cubes in shaker, spring can be taken off for cleaning, suitable for all glasses and shakers

con muelle para mantener los cubitos en la coctelera, el muelle se desmonta para limpiar, se adapta a todos los tipos de vasos y cocteleras

avec ressort pour garder les glaçons dans le shaker, ressort démontable pour lavage, s'adapte à tous types de verres mélangeurs et shakers

	Ø cm	Griff / handle cm	Farbe / Colour	
93347	9	9		copper-antique
93348	9	9		copper-look
93349	9	9		stainless-antique
93312	9	9		stainless steel



Einhandgebrauch  
single-handed use

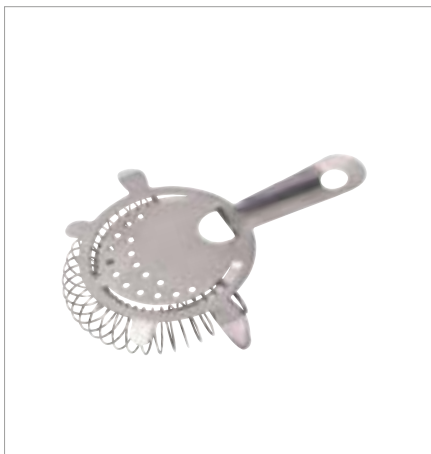

## Barsieb

bar strainer  
colador de cóctel  
tamis cocktail



hochglanzpoliert, Spiralfeder hält Eiswürfel beim Abseihen zurück, Feder kann zur Reinigung entnommen werden, passend für alle Gläser und Shaker

mirror polished, coil spring keeps ice cubes in shaker, spring can be taken off for cleaning, suitable for all glasses and shakers

pulido brillante, con muelle para mantener los cubitos en la coctelera, el muelle se desmonta para limpiar, se adapta a todos los tipos de vasos y cocteleras

poli brillant, avec ressort pour garder les glaçons dans le shaker, ressort démontable pour lavage, s'adapte à tous types de verres mélangeurs et shakers

	Ø cm	Griff / handle cm
93300	8	6



## Julep Barsieb „PRO“

julep strainer  
colador de cóctel  
tamis cocktail



hochglanzpoliert, Einhandgebrauch

mirror polished, single-handed use

pulido brillante, uso con una sola mano

poli brillant, utilisation d'une seule main



	Ø cm	Griff / handle cm
93313	7,5	9





**Barsieb**  
bar strainer  
colador de cóctel  
tamis cocktail



	Ø cm	↑ cm	Griff / handle cm
93318	8,5	5	11,5



**Schneidebrett „BAR“**  
cutting board  
table de corte  
planche à découper



**HDPE, mit Safrinne, mit Antirutschfüßchen**  
HDPE, with juice groove and non-slip feet  
HDPE, con ranura para líquidos y pies antideslizantes  
HDPE, avec rigole et pieds antidérapants

	cm	↑ cm
93306	30 x 20	2
93307	50 x 30	2



**Cocktailmesser „ORANGE“**  
bar knife  
cuchillo para cóctel  
couteau cocktail



**mit 2 Zinken zum Aufspießen von Zitrusseiben**  
with 2 prongs to pick up slices of lemon  
con 2 dientes para pinchar las rodajas de limón, etc.  
avec 2 dents pour les rondelles de citron et autres décorations

	→ cm
88846	21



**Dekoriermesser „ORANGE“**  
decorating knife „cannelé“  
cuchillo acanalador  
couteau canneléur



**gezahnte Klinge aus geschärftem Edelstahl**  
serrated sharpened blade, stainless steel  
hoja de sierra afilada, acero inoxidable  
lame inox microdentée

	→ cm
88843	19



**Zutatenbehälter**  
condiment holder  
dispensador de especias  
boîte à fruits et ingrédients



**500 ml Inhalt pro Fach, 6 Fächer, inklusive Deckel (gefrostet) zur Lagerung**  
6 chambers á 500 ml, including lid for storing  
6 compartimentos de 500 ml., incluye tapa para el almacenaje  
6 compartiments de 500 ml chacun, avec couvercle pour le stockage

	cm	↑ cm
93171	50 x 16	10

**Ersatzbehälter / replacement container / recipiente de recambio / récipient de remplacement**

	cm	↑ cm	fits to
93176	14 x 7,5	7,5	93171



# MUDDLERS



**Stößel**  
muddler  
mortero  
pilon muddler



**mit griffigem Ende, zum Auspressen von Früchten und Zerstoßen von Würfelzucker**  
with handy end, to press fruits or pound lump sugar  
con un acabado en relieve para exprimir frutas y machacar azucarillos  
avec relief grillagé pour presser les fruits ou le sucre en morceaux

	Ø cm	→ cm		Farbe / Colour	€
93358	3,5	20,5	stainless steel		
93360	3,5	20,5	copper-look		
93361	3,5	20,5	stainless-antique		
93362	3,5	20,5	copper-antique		



**Stößel**  
muddler  
mortero  
pilon muddler



**grober Stößel, zum Auspressen von Früchten und Zerstoßen von Würfelzucker**  
coarse notched, to press fruits or pound lump sugar  
mortero grueso con muescas para exprimir frutas y machacar azucarillos  
muddler grand format avec bout relief étoile pour presser les fruits ou le sucre en morceaux

	Ø cm	→ cm	Farbe / Colour
93181	2,5	21	
93182	4	24	



**Stößel**  
muddler  
mortero  
pilon muddler



**aus Buchenholz, mit griffigem Ende, zum Auspressen von Früchten und Zerstoßen von Würfelzucker**  
beech wood, with handy end, to press fruits or pound lump sugar  
madera de haya, acabado relieve para prensar frutas o azucar  
bois de hêtre, avec relief grillagé pour presser les fruits ou le sucre en morceaux

	Ø cm	→ cm	Farbe / Colour
93180	2,5	21	

# LIME AND LEMON SQUEEZERS



## Limetten- / Zitronenpresse

lime- / lemon squeezer  
 exprimidor de limón / lima  
 presse citron

2 Pressringe für Zitrone und Limette

2 squeezing rings for lemon and lime

2 anillos exprimidores para limón y lima

2 anneaux à presser pour le citron et le lime



	cm	↑ cm
93214	21 x 7	5



## Limettenpresse

lime squeezer  
 prensa de limón  
 presse citron



	cm	↑ cm
93189	21 x 7	5



## Zitruspresse

citrus squeezer  
 exprimidor cítricos  
 presse-citron

hochglanzpoliert, 2-teilig

mirror polished, 2 pcs.

pulido brillante, 2 piezas

poli brillant, 2 pièces



	Ø cm	↑ cm	ltr.
71431	12 / 17	10,5	0,35

# ICE CUBE MAKERS



**Eiswürfel | ice cube**  
4 x 4 x 4 cm

**Eiswürfelform mit Deckel, 2er Set**  
ice cube maker with lid, 2 pcs.  
molde para cubitos de hielo con tapa, set de 2  
moule à glaçons avec couvercle, set de 2

**2 Eiswürfelformen für je 9 Eiswürfel**  
2 ice cube moulds for 9 ice cubes each  
2 moldes de cubitos de hielo para 9 cubitos cada uno  
2 moules à glaçons pour 9 glaçons chacun

SILIKON  
SILICON

	cm	↑ cm	ice cubes	pcs.
36102	15,5 x 15,5	5,5	4 x 4 x 4	2

Die Eiswürfel lassen sich leicht auslösen  
the ice cubes are easy to release

**Eiswürfel | ice cube**  
4 x 2,5 x 3 cm

**Eiswürfelform mit Deckel, 2er Set**  
ice cube maker with lid, 2 pcs.  
molde para cubitos de hielo con tapa, set de 2  
moule à glaçons avec couvercle, set de 2

**2 Eiswürfelformen für je 21 Eiswürfel**  
2 ice cube moulds for 21 ice cubes each  
2 moldes de cubitos de hielo para 21 cubitos cada uno  
2 moules à glaçons pour 21 glaçons chacun

PP  
POLYPROPYLENE

	cm	↑ cm	ice cubes	pcs.
36103	25 x 15	4	4 x 2,5 x 3	2

**Eiskugel | ice ball**  
Ø 6 cm

**Eiskugelformer**  
ice ball former  
molde de cubitos de hielo esféricos  
moule à glaçons en boules

**2-teilig, 3 Kugeln à 100 ml, einfach mit Wasser füllen und gefrieren lassen**  
3 bowls à 100 ml, simply fill with water and allow to freeze  
3 bolas de 100 ml, simplemente llenar con agua y dejar congelar  
3 boules à 100 ml, simplement remplir avec de l'eau et mettre à congeler

PP  
POLYPROPYLENE

	cm	↑ cm	ice balls
12990	23,5 x 8,5	6,5	Ø 6



**Eisbox**  
icebox  
cubitera  
seau à glaçons



**Innenbehälter dient als Tropfeinsatz, hält die Eiswürfel bis zu 5 Stunden in ihrer Form**  
inner container serves as drainer, ice bucket keeps the ice cubes in shape for up to 5 hours  
contenedor interior sirve como inserto de goteo, mantiene los cubitos de hielo en forma hasta 5 horas  
récipient intérieur sert d'égouttoir, maintient les glaçons dans leur forme jusqu'à 5 heures

	cm	↑ cm	litr.	
93220	27 x 27	15	5	max. 300 ice cubes



**Eisbox**  
icebox  
cubitera  
seau à glaçons



**Innenbehälter dient als Tropfeinsatz, hält die Eiswürfel bis zu 5 Stunden in ihrer Form**  
inner container serves as drainer, ice bucket keeps the ice cubes in shape for up to 5 hours  
contenedor interior sirve como inserto de goteo, mantiene los cubitos de hielo en forma hasta 5 horas  
récipient intérieur sert d'égouttoir, maintient les glaçons dans leur forme jusqu'à 5 heures

	cm	↑ cm	litr.	
93200	20 x 20	17	3,4	max. 150 ice cubes



**Eisbox**  
icebox  
cubitera  
seau à glaçons



**Innenbehälter dient als Tropfeinsatz, hält bis zu 5 Stunden die Eiswürfel in ihrer Form**  
inner container serves as drainer, keeps the ice cubes in shape for up to 5 hours  
contenedor interior sirve como inserto de goteo, mantiene los cubitos de hielo en forma hasta 5 horas  
récipient intérieur sert d'égouttoir, maintient les glaçons dans leur forme jusqu'à 5 heures

	Ø cm	↑ cm	litr.	
36033	18,5	20	3	max. 150 ice cubes
36037	27	20	6	max. 300 ice cubes



**Eiseimer-Set mit Eiszange**  
ice bucket set with tong  
cubitera clásica con pinza  
seau à glaçons classique avec pince



**mit Abtropfgitter, isolierter Kunststoffeinsatz, Zange lässt sich im Deckel verstauen, für max. 50 Eiswürfel, hält die Eiswürfel bis zu 5 Stunden in ihrer Form**  
with drainer, insulated plastic insert, tongs can be stored in the lid, for max. 50 ice cubes, keeps the ice cubes in shape for up to 5 hours  
con escurridor, inserto de plástico aislado, la pinza se puede guardar en la tapa, para un máximo de 50 cubitos de hielo, mantiene los cubitos de hielo en forma hasta 5 horas  
avec égouttoir, insert en plastique isolé, la pince peut être rangée dans le couvercle, pour max. 50 glaçons, maintient les glaçons dans leur forme jusqu'à 5 heures

	Ø cm	↑ cm	litr.
36015	14	22	1,3

## ICE BUCKETS



### Eiseimer-Set mit Eiszange

ice bucket set with tong  
cubitera clásica con pinza  
seau à glaçons classique avec pince

für max. 45 Eiswürfel, hält die Eiswürfel bis zu 5 Stunden in ihrer Form

max. 45 ice cubes, keeps the ice cubes in shape for up to 5 hours

para un máximo de 45 cubitos de hielo, mantiene los cubitos de hielo en forma hasta 5 horas  
pour max. 45 glaçons, maintient les glaçons dans leur forme jusqu'à 5 heures



	Ø cm	↑ cm	ltr.
36013	12	14	1



3-teiliges Set  
3 pcs.



### Eiszerkleinerer

Ice crusher  
picadora de hielo  
broyeur à glaçons

glasklar, mit Edelstahl-Messer

clear, stainless steel cutters  
cuchillas de acero inoxidable  
couteaux inox



	cm	↑ cm
36017	12 x 12	24



### Eisschaufel

ice scoop  
pala de hielo  
pelle à glaçons



	cm	→ cm	ltr.
93192	10 x 6	29	0,7



### Eisschaufel

ice scoop  
pala de hielo  
pelle à glaçons

gelocht, ideal zum Befüllen von schlanken Gläsern

perforated, ideal to fill narrow glasses

perforada, ideal para llenar vasos estrechos

perforée, idéale pour verser les glaçons dans des verres étroits



	Ø cm	→ cm
93191	5	19,5



**Eiszange**

ice tongs  
pinzas para hielo  
pince de la glace

**hochglanzpoliert, mit Befestigungsclip**

mirror polished, with fastening clip  
pulido brillante, con clip de fijación  
poli brillant, avec clip de fixation



	→ cm	Farbe / Colour
75853	20	stainless steel
75854	20	copper-look
75855	20	gunmetal-look



Zange kann an einer Schale befestigt werden  
tongs can be attached to a bowl

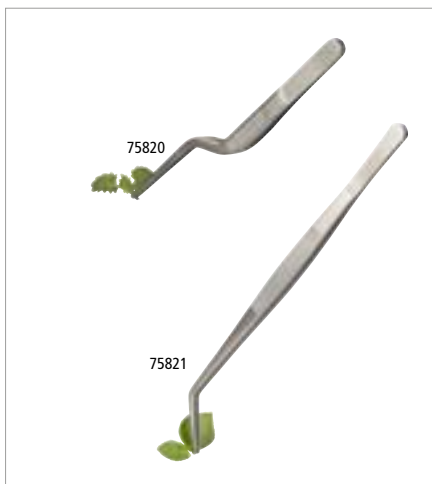

**Pinzettenzange**

fine tong / tweezer  
pinza de emplatat  
pince à dresser

**hochglanzpoliert, geriffelte Grifffläche, schwere Qualität**

mirror polished, ribbed handle, heavy gauge  
pulido brillante, mango cómodo ranurado, alta calidad  
poli brillant, manche rainuré antiglisse, qualité extra



	→ cm
75820	16
75821	30



**Eiszange**

ice cube tong  
pinza para cubitos de hielo  
pince à glaçons

**hochglanzpoliert, fugenlos**

mirror polished, seamless  
pulido brillante, de una sola pieza  
poli brillant, d'une seule pièce



	cm	→ cm
75805	5 x 2	17,5



**Eiszange**

ice tong  
pinza para cubitos de hielo  
pince à glaçons

**matt poliert, mit griffigem Ende, ideal für Eiswürfel und Obstscheiben**

matt polished, with handy end, ideal for ice cubes and fruit slices  
pulido mate, forma ergonómica ideal para cubitos de hielo y láminas de fruta  
poli mat, forme ergonomique idéale pour glaçons et fruits tranchés



	cm	→ cm
93190	2 x 1,5	20



# STRAWS



## Trinkhalme 11er Set

straws, 11 pcs. set  
pajas, set de 11 pz.  
pailles, set de 11 pc.



**11-teiliges Set: 10 Trinkhalme aus Edelstahl + Reinigungsbürste**

11 pcs. set: 10 drinking straws made of stainless steel + cleaning brush  
set de 11: 10 pajas de acero inoxidable + cepillo de limpieza  
set de 11: 10 pailles en acier inox + brosse de nettoyage

	Ø mm	→ cm	Farbe / Colour	
93391	8	15,0		copper-look
93392	8	15,0		gunmetal-look
93393	8	15,0		rainbow-look
93380	6	21,5		copper-look
93381	6	21,5		gunmetal-look
93382	6	21,5		rainbow-look
93383	8	21,5		copper-look
93384	8	21,5		gunmetal-look
93385	8	21,5		rainbow-look

Ersatzbürste / replacement brush / cepillo de recambio / brosse de rechange

	Ø mm	→ cm
93395	8	15
93386	8	20



## Trinkhalme 7er Set

straws, 7 pcs. set  
pajas, set de 7 pz.  
pailles, set de 7 pc.



	Ø mm	→ cm	pcs.
93394	10	15	7
93390	10	21	7







**Barmatte**

drip mat  
tapete escurridor  
tapis de bar

aus weichem Kunststoff, zum Abtropfen von Gläsern etc.  
soft plastic, to store and drain glasses  
plástico blando para escurrir vasos  
plastique souple, pour l'égouttage des verres



	cm	↑ cm	Farbe / Colour	
93168	60 x 8	1		mit Vertiefung
93166	30 x 15	1		ohne Vertiefung
93173	52 x 8	1		ohne Vertiefung
93169	60 x 8	1		ohne Vertiefung
93167	45 x 31	1		ohne Vertiefung

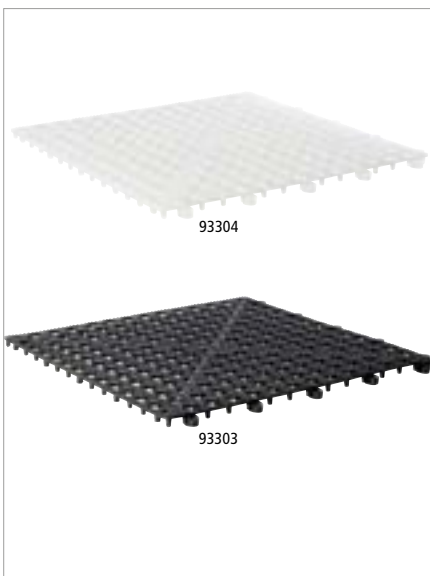

**Abtropfmatte**

drip mat  
esterilla escurridora  
tapis égouttoir

erweiterbar durch Klick-Verbindung  
expandable  
las placas de fijan con clips  
avec clips de fixation



	cm	↑ cm	Farbe / Colour
93304	33 x 33	1,5	
93303	33 x 33	1,5	



**Glasumranderrimber**

glass rimmer  
ribeteador de vasos  
bordeur à verres „rimmer“

Schwamm für Limettensaft, 2 Fächer für Zucker und Salz  
with sponge for lime juice, 2 cases for sugar and salt  
con esponja para zumo de lima, 2 compartimentos para azucar y sal  
avec éponge et 2 compartiments pour sucre et sel



	cm
93175	20 x 7,5



**Bar Caddy**

bar caddy  
organizador de bar  
organisateur „bar caddy“

Ordnungshilfe für Trinkhalme, Rührer, Servietten, Streichhölzer, etc.  
to organize straws, stirrers, napkins, matches, etc.  
para organizar pajitas, cucharillas, servilletas, cerillas, etc.  
pour bien organiser les pailles, agitateurs, cuillers, serviettes et autres accessoires



	cm	↑ cm
93174	24 x 15	11

## CONFERENCE BOTTLE COOLERS



00621

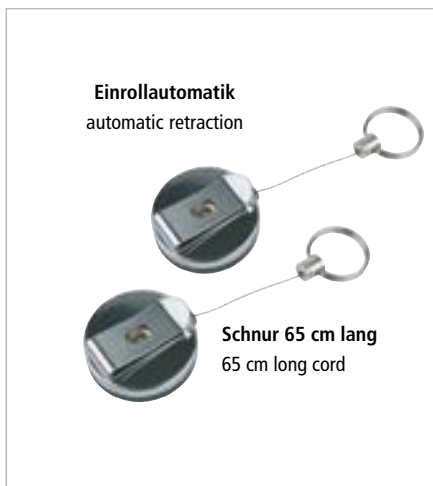

**Einrollautomatik**  
automatic retraction

**Schnur 65 cm lang**  
65 cm long cord

### Flaschenkühler „CONFERENCE“

conference bottle cooler

enfriador múltiple

rafraîchisseur

**inkl. Kühllakku, Flaschenöffner, Kronkorkenschale,**  
**mit 6 Öffnungen Ø 6,7 cm für 0,25 - 0,5 Liter-Flaschen**

incl. bottle cooler, bottle opener, small cap bowl,  
with 6 holes Ø 6,7 cm for 0,25 to 0,5 liter bottle

con acumulador de frío, abridor, recuperador de chapas,  
6 plazas Ø 6,7 cm, para botellas de 25 a 50 cl

avec accumulateur de froid, décapsuleur, bol récupérateur  
de capsules, 6 places Ø 6,7 cm, pour bouteilles de 25 à 50 cl



	Ø cm	↑ cm	Farbe / Colour
00620	23	15	■
00621	23	15	■

**Kühllakku / cooler / acumulador de frío / accumulateur de froid**

	Ø cm	↑ cm	Farbe / Colour
00615	7,5	11,5	■

**Kronkorkenschale / cap bowl / cuenco para chapas / bol récupérateur de capsules**

	Ø cm	↑ cm	Farbe / Colour
00618	6,5	3	■
00619	6,5	3	■

**Flaschenöffner / bottle opener / abridor / décapsuleur**

	Ø cm	→ cm
00617	1	13,5



### Staubkappen, 2er Set

dust & fly cap, 2 pcs.

tapón antipolvo

bouchon anti-poussières et anti-insectes

**schützt vor Staub und Insekten**

protects for dust and insects

para proteger de la suciedad e insectos

pour protéger de la poussière et des insectes



	Ø cm	↑ cm	Farbe / Colour	pcs.
93161	4	8	■	2

### Schlüsselschnur, 2er Set

key cord, 2 pcs.

llavero enrollable

porte-clés avec câble à enroulement

**Befestigung mit Klammer am Gürtel, starke Rückzugfeder**

to fix at waistbelt, strong pull-back spring

se fija en el cinturón, cable retrocede automáticamente

à fixer à la ceinture, enroulage automatique



	Ø cm	↑ cm
93170	4	2



**Dosier- & Vorratsflasche**

pouring container  
botella „store & pour“  
bouteille „store & pour“



4-teilig: Behälter + Flaschenhals + Schraubdeckel + Ausgießer Ø 11 mm mit Luftzufuhr für gezieltes Ausgießen, zum Dosieren und Aufbewahren

4 pcs. set: for storage, mixing and serving drinks, nozzle Ø 11 mm

set de 4 piezas: para almacenar y servir mezclas y bebidas, agujero de Ø 11 mm

se compose de 4 pièces: idéal pour servir et pour conserver les boissons, embout Ø 11 mm

	Ø cm	↑ cm	ltr.	Farbe / Colour
93144	9	33	0,85	
93145	9	33	0,85	
93146	9	33	0,85	
93147	9	33	0,85	
93148	9	33	0,85	



abnehmbarer Boden dient als Deckel  
removable bottom serves as a lid



93308 200 ml

93309

**Spritzflasche inklusive Ausgießer**

squeeze bottle with nozzle  
botella exprimible con dosificador  
flacon pulvérisateur avec bec verseur



ideal für Bitter-Liköre, Essig, Öl

perfect for bitter liqueur, vinegar, oil

perfecto para amargo licor, vinagre, aceite

pour amaro liqueure, vinaigre, huile

	cm	↑ cm	ltr.
93308	6 x 5	20	0,2

Ausgießer passend für Spritzflasche / nozzle suitable for squeeze bottle / dosificador apto para botella exprimible / bec verseur approprié pour flacon pulvérisateur

	Ø cm	↑ cm
93309	2,5	5,5



93141 0,5 ltr.

93101 1,0 ltr.

**Rührglas mit Lippe**

mixing glass with lip  
vaso mezclador vertedor con pico  
verre mélangeur avec bec verseur



schwere Qualität

heavy quality

alta calidad

qualité renforcée

	Ø cm	↑ cm	ltr.
93141	9	16	0,5
93101	11,5	19	1,0

## POURERS



**Permanent-Ausgießer, 6er Set**  
 free flow pourer, 6 pcs.  
 vertedor contínuos set 6 piezas  
 set de 6 bouchons verseurs continus



	↑ cm	pcs.
93110	11	6



**Permanent-Ausgießer, 6er Set**  
 free flow pourer, 6 pcs.  
 vertedor contínuos set 6 piezas  
 set de 6 bouchons verseurs continus



	↑ cm	pcs.
93114	8	6



**Sekt-Verschluss, 2er Set**  
 stopper, 2 pcs.  
 set de 2 taponos  
 set de 2 bouchons



**matt poliert, innen Gummi Arabicum**  
 matt polished, inside rubber arabicum, with inscription  
 pulido mate, interior goma arábica con inscripción  
 poli maté, intérieur gomme arabique

	Ø cm	↑ cm	pcs.
93160	4	5,5	2



**Permanent-Ausgießer, 6er Set**  
 free flow pourer, 6 pcs.  
 vertedor contínuos set 6 piezas  
 set de 6 bouchons verseurs continus



**à 2 Stück: blau, rot, gelb**  
 2 pcs of each colour: blue, red, yellow  
 2 piezas de cada color: azul, rojo, amarillo  
 2 par couleur: bleu, rouge, jaune

	Ø cm	↑ cm	pcs.
93111	3	7,5	6



**Reinigungsbürste für Ausgießer**  
 pourer cleaning brush  
 cepillo de limpieza para picos vertedores  
 brosse lave-bouchons doseurs



	→ cm
93102	16,5



**Kellnermesser „PROFI“**

waiter's corkscrew  
sacacorchos de camarero  
tire-bouchons



leichtgängige Teflon-Spirale, mehrstufige Klapphebelfunktion, am Fuß angebrachtes Messer  
easy moving teflon coil, 2-stage opening system, knife at the bottom end  
mecha de teflón, sistema de apertura en 2 golpes, con cuchillo en la parte superior  
mèche téflon, ouverture en 2 étapes, couteau dans la partie supérieure

→ cm

93302 11,5



**Kellnermesser**

waiter's corkscrew  
sacacorchos de camarero  
tire-bouchons



leichtgängige Teflon-Spirale, mehrstufige Klapphebelfunktion, am Kopf angebrachtes Messer  
easy moving teflon coil, 2-stage opening system, knife at the top end  
mecha de teflón, sistema de apertura en 2 golpes, con cuchilla en la parte superior  
mèche téflon, ouverture en 2 étapes, couteau dans la partie supérieure

→ cm

93301 12



**Kellner-Flaschenöffner**

waiter's barblade  
abridor camarero  
décapsuleur



**matt poliert / matt polished / pulido mate / poli mat**

→ cm

93122 18

00617 13,5



**mit Gummierung**  
with rubber coating

**Kellner-Flaschenöffner**

waiter's barblade  
abridor camarero  
décapsuleur



**mit Gummierung**  
with rubber coating  
con revestimiento de goma  
avec revêtement en caoutchouc

→ cm

93125 11



**Kronkorkenöffner**

bottle cap opener  
abridor de chapas de pared  
décapsuleur mural



**für die Wandmontage, aus massivem Metall, inklusive 2 Schrauben**  
for wall fastening, massive metal, including 2 screws  
para fijación en la pared, metal macizo, incluye 2 tornillos  
massif, à fixer au mur, y compris 2 vis

cm                      ↑ cm

93124 7 x 8 3

# BARISTA

*Life begins after coffee*



10334

## Milch-/Universalkanne

non stick jug  
jarra antiadherente  
pichet antiadhésif

**PTFE-antihafbeschichtet, perfekt für die Herstellung von Milchschaum**

PTFE coated, for baristas frothing hot milk  
revestimiento PTFE, ideal para espume de leche  
revêtement PTFE, idéal pour faire mousser le lait



	Ø cm	↑ cm	ltr.
10334	8,0	10,0	0,35
10335	9,0	11,5	0,60
10336	10,5	13,0	0,80



10329

## Milch- / Universalkanne

milk / water jug  
jarra leche / agua  
pichet à eau / lait

**außen hochglanzpoliert, innen matt poliert, mit Maßskalierung innen**

outside mirror polished, inside matt polished, with dimension scaling inside  
exterior pulido brillante, interior pulido mate, con escala de dimensiones en el interior  
extérieur poli brillant, intérieur poli mat, avec une échelle de dimension à l'intérieur



	Ø cm	↑ cm	ltr.
10328	8,0	10,0	0,35
10329	9,0	11,5	0,6
10330	10,5	13,0	0,8
10331	12,0	16,5	1,3
10332	13,5	18,0	2,0



10350

## Milch- / Universalkanne „VEGAN“

milk / water jug  
jarra leche / agua  
pichet à eau / lait

**außen hochglanzpoliert, innen matt poliert, mit Gravur „VEGAN“**

outside mirror polished, inside matt polished, with engraving „VEGAN“  
exterior pulido brillante, interior pulido mate, con grabado „VEGAN“  
extérieur poli brillant, intérieur poli mat, avec gravure „VEGAN“



	Ø cm	↑ cm	ltr.
10350	9,0	11,5	0,6
10351	10,5	13,0	0,8

NEW



10361

### Milch- / Universalkanne

milk / water jug  
jarra leche / agua  
pichet à eau / lait



**außen weiß pulverbeschichtet, innen matt poliert**

outside white powder coated, inside matt polished  
exterior recubrimiento de polvo blanco, interior pulido mate  
extérieur revêtement en poudre blanc, intérieure poli mat

	Ø cm	↑ cm	ltr.
10360	8,0	10,0	0,35
10361	9,0	10,0	0,50
10362	9,5	11,5	0,75



**mit Gravur am Boden**  
with engraving on the bottom



10323

### Kaffeekanne

coffee pot  
cafetera  
pichet à café



**hochglanzpoliert, mit Klappdeckel**

mirror polished, with hinged cover  
pulido brillante, tapa con bisagra  
poli brillant, couvercle à charnière

	Ø cm	↑ cm	ltr.
10323	8,0	11,5	0,35
10322	9,0	14,0	0,6
10325	10,5	15,5	0,9
10326	12,0	18,5	1,5
10327	13,5	20,0	2,0

NEW



**verstellbar durch Verschieben des Clips**  
adjustable by sliding the clip

### Thermometer für Milchkännchen

thermometer for milk / water jug  
termómetro para jarra leche / agua  
thermomètre pour pichet à eau / lait



**mit Clip, höhenverstellbar, Temperaturbereich 20°C bis 100°C, Graduierung 2°C**

with clip, height adjustable, temperature range 20°C to 100°C, graduation 2°C  
con clip, regulable en altura, rango de temperatura de 20°C a 100°C, graduación 2°C  
avec clip, réglable en hauteur, plage de température 20°C à 100°C, graduation 2°C

	Ø cm	↑ cm
10355	4,0	13,5



**Anwendungsbeispiel**  
application example



### Mini-Milchkanne „SNACKHOLDER“ 4er Set

mini milk can, 4 pcs.  
lechera en formato mini, set de 4  
pot à lait mini, set de 4



	Ø cm	↑ cm	ltr.	pcs.
40640	4,5	5	0,08	4



**Milchkännchen / Sahnegießer, 4er Set**

milk/cream jugs, 4 pcs.  
pack de 4 jarritas para leche o crema  
pack de 4 crémiers

hochglanzpoliert, für Kaffeesahne, mit Griff, Inhalt à 25 ml  
mirror polished, for coffee-cream, with handle, capacity à 25 ml  
pulido brillante, para crema de café, con asa, capacidad 25 ml  
poli brillant, avec anse, 25 ml



	Ø cm	↑ cm	ltr.	pcs.
10321	3,5	3,5	0,025	4



**Milchkännchen / Sahnegießer**

milk / cream jug  
jarra de leche/ crema  
pichet à eau ou lait



	Ø cm	↑ cm	ltr.
10318	4	4	0,05
10319	5	5	0,09
10320	6	6	0,15



**Allzweckgießer**

pourer  
bote vertedor universal  
pot verseur universel  
für Honig, Kaffeesahne, etc., Schraubdeckel  
for honey, cream, etc., screw cap  
para miel, crema, etc., tapa de rosca  
pour le miel, le lait, la crème, etc., bouchon à vis



	Ø cm	↑ cm	ltr.
00765	8,5	13,5	0,3

Ersatzglasbehälter / spare glas-container / contenedor de repuesto / récipient verre de rechange

00768



**Allzweckgießer**

pourer  
dosificador  
doseur  
für Honig, Kaffeesahne, etc., Schraubdeckel  
for honey, cream, etc., screw cap  
para miel, crema, etc., tapa de rosca  
pour le miel, le lait, la crème, etc., bouchon à vis



	Ø cm	↑ cm	ltr.
40488	8	12,5	0,25



**Milch- und Zucker-Set**

bowl  
cuenco  
bol

5-teilig: Tablett, Milchkanne, Zuckerdose mit Deckel, Löffel, Akazienholz, Edelstahl PTFE beschichtet, schwarz

5 pcs.: tray, milk jug, sugar bowl with lid, spoon, acacia wood, stainless inox PTFE coated, black

set de 5: bandeja, jarra de leche, azucarero con tapa, cuchara, madera de acacia, acero inoxidable revestimiento PTFE, negro

set de 5: plateau, pichet à lait, sucrier avec couvercle, cuillère, bois d'acacia, acier inox revêtement PTFE, noir



	cm	↑ cm
00634	19 x 10	10,5





### Zuckerkugel

sugar pot  
azucarero  
sucrier

hochglanzpoliert, mit Rolldeckel

mirror polished, rolltop cover  
pulido brillante, tapa abatible  
poli brillant, couvercle abattant



	Ø cm	↑ cm
00033	13,5	15



170 ml

### Zuckerdosierer

sugar dispenser  
azucarero  
sucrier

matt poliert, Deckel mit Bajonettverschluss / matt polished, lid with bayonet catch / pulido mate, tapa con cierre de bayoneta / poli mat, couvercle avec fermeture à baïonnette



	Ø cm	↑ cm	ltr.
10316	5	15	0,17



40509 200 ml

40508 200 ml

### Zuckerdosierer

sugar dispenser  
azucarero  
sucrier

Schraubdeckel, mit Dosierrohr / screw cap, with dosing tube / tapa de rosca y tubo dosificador / bouchon à vis et tube doseur



	Ø cm	↑ cm	ltr.
40509	6	14,5	0,2
40508	6,5	14,5	0,2



300 ml

### Zuckerdosierer

sugar dispenser  
azucarero  
sucrier

Schraubdeckel, mit Dosierrohr / screw cap, with dosing tube / tapa de rosca y tubo dosificador / bouchon à vis et tube doseur



	Ø cm	↑ cm	ltr.
00766	8,5	15	0,3

Ersatzglasbehälter / spare glass-container / contenedor de repuesto / récipient verre de rechange

00768



320 ml

### Zuckerdosierer

sugar dispenser  
azucarero  
sucrier

Schraubdeckel, mit Dosierrohr / screw cap, with dosing tube / tapa de rosca y tubo dosificador / bouchon à vis et tube doseur



	Ø cm	↑ cm	ltr.
40506	7,5	17,0	0,32



250 ml

**Zuckerdosierer**

sugar dispenser  
azucarero  
sucrier



Schraubdeckel, mit Dosierrohr / screw cap, with dosing tube / tapa de rosca y tubo dosificador / bouchon à vis et tube doseur

	Ø cm	↑ cm	ltr.
40486	8	15	0,25



40490 150 ml

40494 250 ml

**Zuckerdosierer**

sugar dispenser  
azucarero  
sucrier



Schraubdeckel, mit Dosierrohr / screw cap, with dosing tube / tapa de rosca y tubo dosificador / bouchon à vis et tube doseur

	Ø cm	↑ cm	ltr.
40490	8,5	12	0,15
40494	8,0	15	0,25

Ersatzglasbehälter / spare glas-container / contenedor de repuesto / récipient verre de rechange

	fits to
40498	40490
40499	40494



40487  
320 ml

40510  
350 ml

**Zuckerdosierer**

sugar dispenser  
azucarero  
sucrier



Schraubdeckel mit Klappe, mit Dosierklappe / screw cap, with dosing flap / tapa de rosca, con tubo dosificador / bouchon à vis, avec couvercle doseur

	Ø cm	↑ cm	ltr.
40487	7,5	13,5	0,32

Zuckerdosierer „OLD FASHIONED“ / sugar dispenser / azucarero / sucrier

	Ø cm	↑ cm	ltr.
40510	7,5	14	0,35



**Teebrühsieb**

snap mesh tea ball  
infusor de té, pinza con malla  
boule à thé avec pince



matt poliert, mit feinem Sieb, aufklappbar / matt polished, with fine mesh, hinged / pulido mate, con malla fina, con bisagra / poli mat, maille fine, avec charnière

	Ø cm	→ cm
74750	4,5	15,5



**Zitronenschnitzpresse**

lemon slice squeezer  
pinza exprimelimon  
pinza presse citron



hochglanzpoliert, zum Auspressen von Zitronenscheiben / mirror polished, to press lemon slices / pulido brillante, para rodajas de limón / poli brillant, pour citrons en rondelle

	cm
71430	8 x 7

## TEAPOTS



NEW



10995 0,8 ltr.



10996 0,8 ltr.

mit Teesieb / with tea strainer

## Teekanne „ASIA“

teapot  
tetera  
théière

aus Gusseisen, innen emailliert, abnehmbarer Deckel, mit Teesieb aus Edelstahl

made of cast iron, enamelled inside, removable lid, with tea strainer made of stainless steel

hierro fundido, interior esmaltado, tapa extraíble, con colador de té de acero inoxidable

en fonte, émaillé à l'intérieur, couvercle amovible, avec une passoire à thé en acier inox

	cm	↑ cm	ltr.	Farbe / Colour
10995	17 x 14	17	0,8	■
10996	17 x 14	17	0,8	■



10991 0,8 ltr.



10992 0,8 ltr.

mit Teesieb / with tea strainer

## Teekanne „ASIA“

teapot  
tetera  
théière

aus Gusseisen, innen emailliert, mit abnehmbarem Deckel,

inklusive Teesieb aus Edelstahl, ideal für 2-3 Tassen. Geeignet für alle Herdarten.

made of cast iron, enamelled inside, with removable lid, incl. tea strainer made of stainless steel, ideal for 2-3 cups. Suitable for all types of stoves.

hierro fundido, interior esmaltado, con tapa extraíble, incl. colador de té de acero inoxidable, ideal para 2-3 tazas. Apta para todas las placas de cocina.

en fonte, émaillé à l'intérieur, avec couvercle amovible, y compris une passoire à thé en acier inox, idéale pour 2-3 tasses. Convient à tous les types de feux (gaz, vitro ou induction).

	cm	↑ cm	ltr.	Farbe / Colour
10991	19,5 x 18	15	0,8	■
10992	19,5 x 18	15	0,8	■



0,3 ltr.

ohne Teesieb / without tea strainer

## Teekanne „ASIA“

teapot  
tetera  
théière

aus Gusseisen, innen emailliert, mit abnehmbarem Deckel, ohne Teesieb aus Edelstahl

made of cast iron, enamelled inside, with removable lid, without tea strainer made of stainless steel

hierro fundido, interior esmaltado, con tapa extraíble, sin colador de té de acero inoxidable

en fonte, émaillé à l'intérieur, avec couvercle amovible, sans une passoire à thé en acier inox

	cm	↑ cm	ltr.	Farbe / Colour
10990	12,5 x 11	12,5	0,3	■



30130



30131



30132



30133



30140



30141



30142

Tablett „VINTAGE“

tray  
bandeja  
plateau

Antik-Edelstahl-Look  
stainless steel antique look  
acero estilo antiguo  
acier style antique



	cm	↑ cm	
30130	26,0 x 13,5	1,5	rectangular
30131	34,0 x 18,0	1,5	rectangular
30132	38,0 x 26,5	1,5	rectangular
30133	25,5 x 16,0	3,0	rectangular
30140	20,0 x 14,5	1,0	oval
30141	26,5 x 19,5	1,0	oval
30142	29,0 x 22,0	1,0	oval

passende Schälchen / fitting bowls / cuencos adecuados / bols apropiés



	Ø cm	↑ cm	litr.
40655	7,5	5,5	0,17
40656	7,5	10	0,35



Wachspapier „SNACKHOLDER“ / greaseproof paper squares  
papel alimenticio para cucurucho / papier alimentaire pour cornet



	cm	pcs.	
40670	42 x 25	500	Motiv: Zeitung



30130



30132



30141

Servierbeispiel  
presentation example

**Serviertablett „KAFFEEHAUS“**

tray  
bandeja  
plateau

**matt poliert, Rand eingerollt**

matt polished, rolled edge

acabado pulido efecto pulido mate, borde redondeado

effet poli mat, bord rond



	cm	↑ cm
30119	23 x 23	1,5
30118	21,5 x 13	1,5

**Serviertablett „KAFFEEHAUS“**

tray  
bandeja  
plateau

**matt poliert, oval, Rand eingerollt**

matt polished, oval, rolled edge

pulido mate, oval, borde redondeado

poli mat, ovale, bord rond

**für Zucker und Sahne / for sugar and cream / para azúcar y crema / pour le sucre et la crème**

	cm	↑ cm
30111	20,0 x 14,5	0,5

**für eine Tasse / for one cup / para una taza / pour une tasse**

	cm	↑ cm
30112	26,5 x 19,5	0,5

**für zwei Tassen / for two cups / para dos tazas / pour deux tasses**

	cm	↑ cm
30113	29,0 x 22,0	0,5

**Serviertablett „KAFFEEHAUS“**

tray  
bandeja  
plateau

**hochglanzpoliert, oval, Rand eingerollt**

mirror polished, oval, rolled edge

pulido brillante, ovalado, borde redondeado

poli brillant, ovale, bord rond

**für Zucker und Sahne / for sugar and cream / para azúcar y crema / pour le sucre et la crème**

	cm	↑ cm
30115	20,0 x 14,5	0,5

**für eine Tasse / for one cup / para una taza / pour une tasse**

	cm	↑ cm
30116	26,5 x 19,5	0,5

**für zwei Tassen / for two cups / para dos tazas / pour deux tasses**

	cm	↑ cm
30117	29,0 x 22,0	0,5



# TRAYS



## Serviertablett „KAFFEEHAUS“

tray  
bandeja  
plateau  
matt poliert, oval  
matt polished, oval  
pulido mate, oval  
poli mat, ovale



	cm	↑ cm
30126	25,5 x 19,5	2



## Serviertablett „KAFFEEHAUS“

tray  
bandeja  
plateau  
hochglanzpoliert, stabiler Rand eingerollt  
mirror polished, stable edge rolled in  
pulido brillante, borde estable enrollado  
poli brillant, bord stable enroulé



	cm	↑ cm
30148	Ø 27	1,5
30149	30 x 15,5	1,5

passende Hauben / cover / campana / cloche



	cm	↑ cm	suitable for
11055	Ø 23	12,0	30148
11056	26 x 12	10,0	30149



Servierbeispiel  
presentation example



## Serviertablett „KAFFEEHAUS“

tray  
bandeja  
plateau  
Innenfläche ziseliert, Rand eingerollt  
chiselled inner surface, rolled edge  
superficie interior cincelada, borde redondeado  
surface intérieure ciselée bord rond



	cm	VE / unit
30114	30 x 22	48



## Serviertablett „KAFFEEHAUS“

tray  
bandeja  
plateau



	cm	↑ cm	Farbe / Colour
84251	26,0 x 20,0	1,5	■
84253	28,5 x 21,5	1,5	■

**Tablett „BISTRO“**

tray  
bandeja  
plateau

**rutschfest, mit 2 Griffmulden und Stapelrand**

non-slip, two open handles, stackable edge

anti-deslizante, 2 asas

antidérapant, 2 anses



	Ø cm	↑ cm	Farbe / Colour
84045	35,5	4,5	■



00510

**Serviertablett „HAPPY HOUR“**

tray  
bandeja  
plateau

**rutschfeste Oberfläche**

non-slip surface

superficie anti-deslizante

surface antidérapante



	Ø cm	↑ cm	Farbe / Colour
00510	32	1,5	■
00511	38	1,5	■
00515	43	1,5	■



00500

**Bierglasträger „NON-SLIP“**

beer rack

bandeja para cerveza

porte verre à bière

**rutschfeste Oberfläche**

non-slip surface

superficie anti-deslizante

surface antidérapante



	Ø cm	↑ cm	Farbe / Colour
00500	36	3,5	■

	cm	↑ cm	Farbe / Colour
00506	28 x 20	1,5	■



00548

**Tablett „GASTRO“**

tray  
bandeja  
plateau

**rutschfeste Oberfläche**

non-slip surface

superficie anti-deslizante

surface antidérapante



	Ø cm	↑ cm	Farbe / Colour
00547	27,5	2	■
00548	35,5	2	■
00549	40,5	2	■

## TRAYS



### Tablett

tray  
bandeja  
plateau

**rutschfest, Mahagonifurnier**

non-slip, woodform, mahogany  
antideslizante  
antidérapant



	Ø cm	↑ cm
00528	31,0	3,5
00529	35,5	3,5



### Tablett

tray  
bandeja  
plateau

**rutschfest, Holzdekor-Laminat**

non-slip, coated wood  
antideslizante  
antidérapant



	cm	↑ cm
00521	26 x 20	1
00522	29 x 21	1



### Tablett

tray  
bandeja  
plateau

**rutschfest, Holzdekor-Laminat**

non-slip, coated wood  
antideslizante  
antidérapant



	cm	↑ cm
00524	43,5 x 31,5	1,5
00525	52,0 x 39,0	1,5
00526	60,5 x 42,5	1,5



### Serviertablett „NON-SLIP“

tray non-slip  
bandeja antideslizante  
plateau antiglisse

**rutschfeste Oberfläche**

non-slip surface  
superficie antideslizante  
surface antidérapante



	cm	↑ cm	GN	Farbe / Colour
00502	53 x 32,5	1,5	1/1	■
00508	46 x 36,0	2		■



# FAST FOOD TRAYS



00535



00536



00537



00538



00534



00539

**Fast Food-Tablett**  
 snack tray  
 bandeja autoservicio y snacks  
 plateau self-service et snacks



	cm	↑ cm	GN	Farbe / Colour
00530	35 x 27,0	2		
00535	41 x 30,5	2		
00540	45 x 35,5	2		
00552	53 x 32,5	2	1/1	

	cm	↑ cm	GN	Farbe / Colour
00531	35 x 27,0	2		
00536	41 x 30,5	2		
00541	45 x 35,5	2		
00553	53 x 32,5	2	1/1	

	cm	↑ cm	GN	Farbe / Colour
00532	35 x 27,0	2		
00537	41 x 30,5	2		
00542	45 x 35,5	2		
00554	53 x 32,5	2	1/1	

	cm	↑ cm	GN	Farbe / Colour
00533	35 x 27,0	2		
00538	41 x 30,5	2		
00543	45 x 35,5	2		
00555	53 x 32,5	2	1/1	

	cm	↑ cm	Farbe / Colour
00534	35 x 27,0	2	

	cm	↑ cm	Farbe / Colour
00539	35 x 27,0	2	



stapelbar  
 stackable



**Rechnungstablett**

bill presenter  
porta cuenta  
porte-addition

**mit Klemme für Rechnung**  
with clip for bill  
con clip para la nota  
avec clip pour la note



	cm	↑ cm
30108	20 x 12	1,5



**Rechnungstablett**

bill presenter  
porta cuenta  
porte-addition

**mit Klemme für Rechnung**  
with clip for bill  
con clip para la nota  
avec clip pour la note



	cm	↑ cm
30110	17 x 11	1



**Tischkrümelentferner**

crumber  
recogemigas  
ramasse-miettes

**geschliffene Edelstahlkante, matt poliert, einfache Handhabung**  
flat grinded stainless steel edge, matt polished, easy to handle  
geschliffene Edelstahlkante, pulido mate, fácil de usar, mango hueco  
geschliffene Edelstahlkante, poli mat, manche creux, simple à utiliser



	Ø cm	↑ cm
00581	19,5 x 4,5	1



71400

**Rezeptionsglocke**

ring bell  
timbre  
sonnette



	Ø cm	↑ cm	Farbe / Colour
71400	8,5	6,0	■
71433	10,0	6,5	■

## ASHTRAYS



## Windaschenbecher

ashtray  
cenicero  
cendrier



Metall verchromt, Glas gefrostet, mit Bajonettverschluss

metal chrome plated, glass frosted, bayonet lock

metal cromado, opaco mate, cierre de bayoneta

métal chromé, mat, verrouillage par baïonnette

	Ø cm	↑ cm	Farbe / Colour
00582	9,5	8	
00583	9,5	8	
00584	9,5	8	
00585	9,5	8	



## Windaschenbecher

ashtray  
cenicero  
cendrier



Metall verchromt, Glas gefrostet, mit Bajonettverschluss

metal chrome plated, glass frosted, bayonet lock

metal cromado, opaco mate, cierre de bayoneta

métal chromé, mat, verrouillage par baïonnette

	Ø cm	↑ cm	Farbe / Colour
00560	9,5	8	
00561	9,5	8	
00562	9,5	8	
00563	9,5	8	
00564	9,5	8	





**Drehaschenbecher „PUSH“**

ashtray  
cenicero  
cendrier



**Deckel mit Drehmechanismus, mit Bajonettverschluss**  
with rotary button, bayonet lock  
con botón giratorio, cierre de bayoneta  
tourne par pression sur le bouton, verrouillage par baïonnette

	Ø cm	↑ cm
00568	9,5	11



Drehmechanismus  
rotary button



**Drehaschenbecher „KLASSIKER“**

ashtray  
cenicero  
cendrier giratoire



**Deckel mit Drehmechanismus**  
with rotary button  
con botón giratorio  
tourne par pression sur le bouton

	Ø cm	↑ cm	Farbe / Colour
00054	13,0	10,5	
00056	10,5	11	

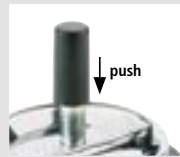

Drehmechanismus  
rotary button



**Windaschenbecher**

ashtray  
cenicero  
cendrier



**Deckel hochglanzpoliert, Behälter matt poliert, mit Windschutzdeckel**  
lid mirror polished, container matt polished, with windcover  
con tapa antiviento pulida brillante y contenedor pulido efecto pulido mate  
couverture anti-vent brillant, corps poli mat poli maté

	Ø cm	↑ cm
00052	12	5,5



Klappmechanismus  
rotary button



**Windaschenbecher „ELEMENT“**

ashtray  
cenicero  
cendrier



**möbelschonende Unterseite**  
non-scratching undersurface  
base anti rayaduras  
avec revêtement antirayures

	Ø cm	↑ cm
000570	10,5	5,0



00091

Windaschenbecher

ashtray  
cenicero  
cendrier

**matt poliert, mit Windschutzdeckel**  
matt polished, with windcover  
pulido mate apilable, tapa para el viento  
poli mat, empilable, couvercle anti-vent



	Ø cm	↑ cm
00090	10	4,5
00091	12	4,5



stapelbar  
stackable



83488

Windaschenbecher

ashtray  
cenicero  
cendrier



	Ø cm	↑ cm	Farbe / Colour
83488	11,5	5	white
83489	11,5	5	black



83611

Windaschenbecher

ashtray  
cenicero  
cendrier



	Ø cm	↑ cm	Farbe / Colour
83610	10	4,0	white
83612	12	4,5	white
83611	10	4,0	black
83613	12	4,5	black



Windaschenbecher „SMOKY“

ashtray  
cenicero  
cendrier

**mit abnehmbarem Deckel**  
with removable lid  
con tapa extraible  
avec couvercle amovible



	Ø cm	↑ cm	Farbe / Colour
00586	8,5	11,5	schwarz / black
00578	8,5	11,5	verzinkt / galvanised

## ASHTRAYS



### Aschenbecher

ashtray  
cenicero  
cendrier



	Ø cm	↑ cm	Farbe / Colour
83616	9,5	4,5	■



### Aschenbecher

ashtray  
cenicero  
cendrier



**matt poliert, hochwertige schwere Ausführung**

matt polished, high quality, heavy gauge  
pulido pulido mate, alta calidad, apilable  
poli mat, empilable, belle qualité

	Ø cm	↑ cm
00048	8	3
00050	10	3



### Aschenbecher, 3er Set

ashtray, 3 pcs.  
set de 3 cenicero  
set de 3 cendriers



	Ø cm	↑ cm	Farbe / Colour	pcs.
00576	8	3	■	3



### Standascher „DIABOLO“

standing ashtray  
cenicero de pie  
cendrier sur pied



**für den Innen- und Außenbereich, inklusive 1,5 kg Sand, eine Ascheschale für die Sandbefüllung und ein Metallsieb**

for in,- outdoor use, included a bag of sand and a metal sieve

uso en interior o exterior, incluye una bolsa de arena y embudo de metal

usage en intérieur ou extérieur, livré avec un sac de sable et entonnoir métal

	Ø cm	↑ cm
00574	40	60



vielseitig nutzbar  
versatile



zerlegbar und stapelbar  
dismountable and stackable



## Tretbeutelhalter

pedal bin  
soporte a pedal  
poubelle à pédale

geeignet für Müllbeutel bis 120 ltr., 110 x 70 cm

suitable for bags up to 120 ltr., 110 x 70 cm

apto para bolsas hasta 120 l., medidas sin bolsa 110 x 70 cm

apte pour sacs de 120 l., dim. sans sac 110 x 70 cm

	cm	↑ cm
00580	59 x 43	96



Gummilippe 55 cm breit, Abstand zwischen Gummilippe und Bodenblech 82 cm



leichte Bedienung, Trittmechanismus  
easy handling, step on bin

2 Lenkrollen mit Feststellern  
2 wheels with brakes

NEW

# Der nachhaltige Mehrwegbecher – made in Germany



eco-friendly



Das Ribbendesign isoliert die Hitze – kein „Verbrennen“ der Finger möglich

The rib design insulates the heat - no „burning“ of the fingers possible

Mehrwegbecher individuell mit Ihrem Logo/Namen herstellbar ab 500 Stck. – sprechen Sie uns an!

Reusable cups can be individually produced with your logo/name. From 500 pieces - please contact us!

- ✓ aufsteckbarer Deckel mit Trinköffnung
- ✓ 100% recyclebar
- ✓ spülmaschinengeeignet
- ✓ stapelbar mit und ohne Deckel
- ✓ schwappsicher

- clip-on lid with drinking opening
- 100% recyclable
- dishwasher safe
- stackable with and without lid
- slosh-/leak-proof

NEW



## To Go Mehrwegbecher

To Go reusable cup  
vaso reutilizable To Go  
tasse réutilisable To Go  
**Becher (ohne Deckel)**  
cup (without cover)  
vaso (sin tapa)  
tasse (sans couvercle)



	Ø cm	↑ cm	ltr.	Farbe / Colour	VE / unit
66910	8,5	13,5	0,4		48
66911	8,5	13,5	0,4		48
66912	8,5	13,5	0,4		48
66913	8,5	13,5	0,4		48

### Deckel / cover / tapa / couvercle

	Ø cm	↑ cm	Farbe / Colour	VE / unit
66914	8,5	2,5		48
66915	8,5	2,5		48
66916	8,5	2,5		48
66917	8,5	2,5		48



# DRINKING BOTTLE



## Trinkflasche drinking bottle cantimplora gourde

EDELSTAHL  
STAINLESS  
INOX  
18/8

HOLZ  
WOOD

die doppelwandige Vakuumflasche aus Edelstahl hält Heißes 12 Stunden heiß und Kaltes 24 Stunden kalt, 100% auslaufsicher

the double-walled stainless steel vacuum bottle keeps hot drinks hot for 12 hours and cold drinks cold for 24 hours, 100% leak proof

la cantimplora al vacío de acero inoxidable de doble pared mantiene las bebidas calientes durante 12 horas y las frías durante 24 horas, 100% transporte sin salpicaduras

la gourde à vide en acier inoxydable à double paroi permet de conserver les boissons chaudes pendant 12 heures et les boissons froides pendant 24 heures, 100% transport sans éclaboussures

	Ø cm	↑ cm	ltr.
66905	7,5	24,5	0,5



## Trinkflasche drinking bottle cantimplora gourde

EDELSTAHL  
STAINLESS  
INOX  
18/8

HOLZ  
WOOD

die doppelwandige Vakuumflasche aus Edelstahl hält Heißes 12 Stunden heiß und Kaltes 24 Stunden kalt, 100% auslaufsicher

the double-walled stainless steel vacuum bottle keeps hot drinks hot for 12 hours and cold drinks cold for 24 hours, 100% leak proof

la cantimplora al vacío de acero inoxidable de doble pared mantiene las bebidas calientes durante 12 horas y las frías durante 24 horas, 100% transporte sin salpicaduras

la gourde à vide en acier inoxydable à double paroi permet de conserver les boissons chaudes pendant 12 heures et les boissons froides pendant 24 heures, 100% transport sans éclaboussures

	Ø cm	↑ cm	ltr.
66906	7,5	29,5	0,75



...immer dabei



mit Schraubverschluss  
with screw cap

inkl. Ersatzdichtung  
incl. spare gasket

500 ml

750 ml

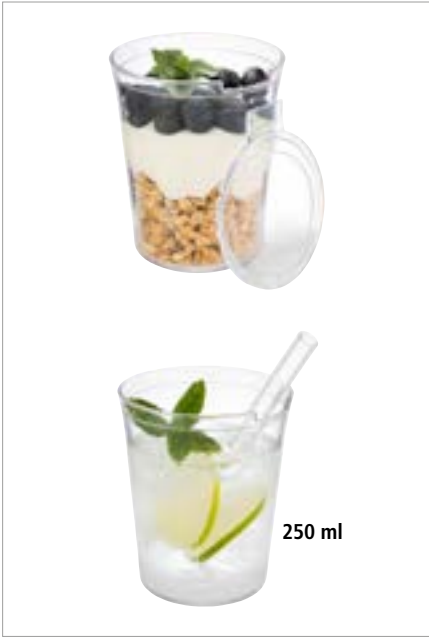

250 ml

**Becher Set „SUPER CUP“, 8er Set**

barrel mug set, 8 pcs.  
vasos, set de 8  
gobelets, set de 8

**Set bestehend aus 8 Bechern + 8 Deckeln**  
set consists of 8 barrel mugs + 8 lids  
set compuesto por 8 vasos + 8 tapas  
set composé de 8 gobelets + 8 couvercles



**IDEAL**  
FÜR  
„TAKE AWAY“

	Ø cm	↑ cm	ltr.	pcs.
10506	8	10	0,25	8



mit Stapelnocke  
with stacking cam



rutschfester Deckel  
non-slip lid



Servierbeispiel Deckel  
presentation example cover



30357

30358

**Lunchbag, 2er Set**

lunch bag, 2 pcs.  
bolsa de almuerzo, set de 2  
sac à lunch, set de 2

**70% Naturfaser und 30% Kunstharz, mit Klettverschluss**

70% natural fibre and 30% synthetic resin, with velcro fastener

70% fibra natural y 30% resina sintética, con cierre de velcro

70% de fibres naturelles et 30% de résine synthétique, avec fermeture velcro



	cm	↑ cm	pcs.
30357	16 x 10	32	2
30358	25 x 15	30	2



30358

Präsentationsmöglichkeit  
presentation example



# Lunchbox



## Lunchbox „M“

lunchbox  
fiambrella  
boîte à lunch



**Edelstahlbox mit Silikondichtung inkl. Trennsteg, auslaufsicher**

stainless steel box with silicone seal incl. divider, leak-proof

caja de acero inoxidable con junta de silicona y divisor extraíble, transporte sin salpicaduras

boîte en acier inox avec joint en silicone et diviseur amovible, transport sans éclaboussures

	cm	↑ cm	ltr.
66900	18,5 x 13,5	6,5	0,8



## Lunchbox „L“

lunchbox  
fiambrella  
boîte à lunch



**Edelstahlbox mit Silikondichtung inkl. Trennsteg, auslaufsicher**

stainless steel box with silicone seal incl. divider, leak-proof

caja de acero inoxidable con junta de silicona y divisor extraíble, transporte sin salpicaduras

boîte en acier inox avec joint en silicone et diviseur amovible, transport sans éclaboussures

	cm	↑ cm	ltr.
66901	20,5 x 14,5	6,5	1,1



## Lunchbox „XL“

lunchbox  
fiambrella  
boîte à lunch



**Edelstahlbox mit Silikondichtung inkl. Trennsteg, auslaufsicher**

stainless steel box with silicone seal incl. divider, leak-proof

caja de acero inoxidable con junta de silicona y divisor extraíble, transporte sin salpicaduras

boîte en acier inox avec joint en silicone et diviseur amovible, transport sans éclaboussures

	cm	↑ cm	ltr.
66902	22,5 x 16,5	6,5	1,4



mit zwei Verschlüssen  
with 2 clasps

66900

0,8 ltr.



66901

1,1 ltr.



66902

1,4 ltr.



herausnehmbarer Trennsteg  
removable divider

auslaufsicher | leak-proof







# Servier- & Küchenhelfer

serving items & kitchentools

herramientas de cocina

outils de cuisine

BANQUET.....	438
PROFI.....	440
CLASSIC.....	441
STOP TOOLS.....	442
POLYAMIDE KITCHENTOOLS.....	444
TONGS.....	446
TWEEZERS.....	452
DELICATESSEN SPOONS.....	453
SPOONS   WOOD.....	454
ORANGE.....	456
BLUE.....	459
CUTTERS   WHISKS.....	462
STRAINERS.....	463
CONFECTIONARY KITCHENTOOLS.....	466
MEASURING CUPS.....	467
STIRRING CUPS   MOUSSE RINGS.....	468
DARIOL MOULDS   CAKE SETTING RINGS   DISPLAY TRAYS...	469
BUCKETS   SCOOPS.....	470
FUNNELS.....	471
SQUEEZERS   BRUSHES   BREADING SETS.....	472
BILL RAILS   KNIFE RACKS   TEAR-OFF-DISPENSERS.....	473
KITCHEN TOOLS.....	474
SQUEEZE BOTTLES.....	475
DISPENSERS   EGG BOXES.....	477
PIZZA.....	478

# BANQUET



Die Vorlegeserie BANQUET ist die passende Ergänzung zum Servieren am Buffet. Durch die mattierte Oberfläche und das gebogene Griffende wird BANQUET praktischen und optischen Ansprüchen gerecht.

The series BANQUET is the perfect addition for serving at the buffet. Due to the matt surface and the curved handle, BANQUET meets practical and optical requirements.

La serie BANQUET es la adición perfecta para servir en el buffet. Debido a la superficie mate y al mango curvado, BANQUET cumple con requisitos prácticos y ópticos.

La série BANQUET est l'ajout parfait pour servir au buffet. Grâce à la surface mate et la poignée incurvée, BANQUET répond aux exigences pratiques et optiques.



## Salat- / Servierlöffel „BANQUET“ salad spoon / serving spoon cuchara para ensalada / cuchara de servicio cuillère à salade / cuillère de service



	cm	Griff / handle cm
00588	6 x 5	17
00590	7,5 x 6	21



## Salatgabel „BANQUET“ salad fork tenedor de servicio para ensalada fourchette de service pour la salade



	cm	Griff / handle cm
00589	6 x 5	17
00591	7,5 x 6	21

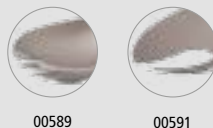

## Schöpflöffel „BANQUET“ ladle cucharón louche



	cm	Griff / handle cm
00595	8,5 x 7,5	24



**Chafing Dish Löffel „BANQUET“**

serving spoon  
cuchara para servir  
cuillère de service



	cm	Griff / handle cm	
00592	11 x 6,5	24	
00593	11 x 6,5	24	geschlitzt / slotted



00593



**Dressinglöffel „BANQUET“**

dressing spoon  
cuchara de aliño  
cuillère à vinaigrette



	cm	Griff / handle cm
00594	6 x 4	30



**Pfannenwender „BANQUET“**

turner  
espátula  
spatule



	cm	Griff / handle cm
00587	10 x 7,5	21



**Fleischgabel „BANQUET“**

meat fork  
tenedor de carne  
fourchette à viande



	cm	Griff / handle cm
00596	8 x 2,5	13



**Serviergabel „BANQUET“**

fork  
tenedor de servicio  
fourchette de service



	cm	Griff / handle cm
00597	9 x 4	21



**Tortenheber „BANQUET“**

cake lifter  
pala de tartas  
pelle à gâteau  
eine Kante gezahnt  
one edge serrated  
un borde serrado  
denté sur un côté



	cm	Griff / handle cm
00598	14 x 6	13

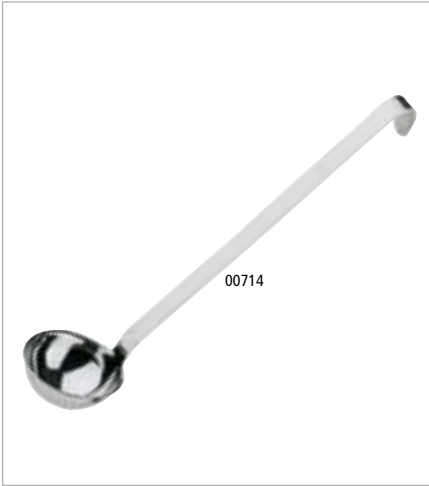

Schöpflöffel „PROFI“

ladle  
cacillo  
louche



	Ø cm	Griff / handle cm	litr.
00711	6	28	0,050
00712	7	30	0,080
00713	8	32	0,125
00714	9	33	0,150
00715	10	35	0,250
00716	11	36	0,300



Schaumlöffel „PROFI“

skimmer  
espumadera  
écumoire



	Ø cm	Griff / handle cm
00721	10	34
00722	12	37
00723	14	40



Wender „PROFI“

turner  
espátula  
spatule



	cm	Griff / handle cm
00730	10 x 11,5	38



Servierlöffel „PROFI“

serving spoon  
cuchara de servicio  
cuillère de service



	cm	Griff / handle cm	
00671	11 x 7	29	geschlitzt / slotted
00672	11 x 7	29	



Spaghettilöffel „PROFI“

spaghetti spoon  
cuchara de espaguetis  
cuillère à spaghettis



	cm	Griff / handle cm
00673	10 x 7	29





**Servierlöffel „CLASSIC“**

servicing spoon  
cuchara de servicio  
cuillère de service



hochglanzpoliert, perforiert, Löcher Ø 4 mm, ergonomisch profilierter Hohl-Griff  
mirror polished, perforated, holes Ø 4 mm, ergonomic designed handle  
pulido brillante agujeros de Ø 4 mm, asa ergonómica  
brillant, trous Ø 4 mm, manche ergonomique

	cm	Griff / handle cm
75903	9,5 x 7	23,5



**Salatlöffel „CLASSIC“**

salad spoon  
cuchara para ensalada  
cuillère à salade



hochglanzpoliert, ergonomisch profilierter Hohl-Griff  
mirror polished, ergonomic designed handle  
pulido brillante, asa ergonómica  
poli brillant, manche ergonomique

	cm	Griff / handle cm
75902	8 x 6	21,5
75904	9,5 x 7	23,5



**Suppenkelle „CLASSIC“**

soup ladle  
cucharón de sopa  
louche de service



hochglanzpoliert, ergonomisch profilierter Hohl-Griff  
mirror polished, ergonomic designed handle  
pulido brillante, asa ergonómica  
poli brillant, manche ergonomique

	Ø cm	Griff / handle cm	litr.
75907	7	23	0,06
75908	9	24	0,1



**Saucengießlöffel „CLASSIC“**

sauce / gravy ladle  
cucharón de salsa  
cuillère à sauce



hochglanzpoliert, ergonomisch profilierter Hohl-Griff, fugenlos  
mirror polished, ergonomic designed handle, seamless  
pulido brillante, asa ergonómica, sin soldadura  
poli brillant, manche ergonomique, monobloc (sans soudure)

	cm	Griff / handle cm	litr.
75906	7 x 5,5	22	0,02



**Tortenheber „CLASSIC“**

cake lifter  
pala de tartas  
pelle à gâteau



hochglanzpoliert, mit einer gezahnten Kante, ergonomisch profilierter Hohl-Griff  
mirror polished, one edge serrated, ergonomic designed handle  
pulido brillante, canto dentado, mango ergonómico  
poli brillant, bord microdenté, manche ergonomique

	cm	Griff / handle cm
75900	8 x 5	10,5
75912	5 x 1	12

# STOP-TOOLS

Die STOP-Funktion verhindert, dass Gabel oder Löffel in das Gefäß rutschen.

The smart STOP-function prevent forks and spoon not to slip into the vessel.

La función STOP evita que los cubiertos se caigan dentro del recipiente.

La fonction STOP empêche les couverts de glisser dans le récipient.



## Servierlöffel

serving spoon  
cuchara para servir  
cuillère à servir



**Materialdicke 2,5 mm, ergonomischer, rutschfester Griff**  
material thickness: 2,5 mm, ergonomic antislip handle  
grosor: 2,5 mm, mango ergonómico antideslizante  
épaisseur : 2,5 mm, poignée ergonomique antidérapante

	cm	Griff / handle cm
00834	10 x 7,5	17



## Servierlöffel geschlitzt

slotted spoon  
cuchara para servir ranurada  
cuillère à servir rainurée



**Materialdicke 2,5 mm, ergonomischer, rutschfester Griff**  
material thickness: 2,5 mm, ergonomic antislip handle  
grosor: 2,5 mm, mango ergonómico antideslizante  
épaisseur : 2,5 mm, poignée ergonomique antidérapante

	cm	Griff / handle cm
00833	10 x 7,5	17



## Schöpflöffel

ladle  
cucharón  
louche



**Materialdicke 2,5 mm, ergonomischer, rutschfester Griff**  
material thickness: 2,5 mm, ergonomic antislip handle  
grosor: 2,5 mm, mango ergonómico antideslizante  
épaisseur : 2,5 mm, poignée ergonomique antidérapante

	Ø cm	Griff / handle cm
00832	9	17



## Fleischgabel

meat fork  
tenedor de carne  
fourchette à viande



**Materialdicke 2,5 mm, ergonomischer, rutschfester Griff**  
material thickness: 2,5 mm, ergonomic antislip handle  
grosor: 2,5 mm, mango ergonómico antideslizante  
épaisseur : 2,5 mm, poignée ergonomique antidérapante

	cm	Griff / handle cm
00831	10,5 x 4	17

**Servierlöffel geschlitzt**

slotted spoon

cuchara para servir ranurada

cuillère à servir rainurée

**ergonomischer, rutschfester Griff**

ergonomic antislip handle

mango ergonómico antideslizante

poignée ergonomique antidérapante



cm

Griff / handle cm

00664

11 x 7

25

**Servierlöffel**

serving spoon

cuchara para servir

cuillère à servir

**ergonomischer, rutschfester Griff**

ergonomic antislip handle

mango ergonómico antideslizante

poignée ergonomique antidérapante



cm

Griff / handle cm

00662

11 x 7

25

**Schöpflöffel**

ladle

cucharón

louche

**ergonomischer, rutschfester Griff**

ergonomic antislip handle

mango ergonómico antideslizante

poignée ergonomique antidérapante



cm

Griff / handle cm

ltr.

00670

9 x 8

25

0,10

**Wender**

turner

espátula

spatule

**ergonomischer, rutschfester Griff**

ergonomic antislip handle

mango ergonómico antideslizante

poignée ergonomique antidérapante



cm

Griff / handle cm

00668

10 x 8

25

**Fleischgabel**

meat fork

tenedor de carne

fourchette à viande

**ergonomischer, rutschfester Griff**

ergonomic antislip handle

mango ergonómico antideslizante

poignée ergonomique antidérapante



cm

Griff / handle cm

00666

10 x 3,5

25

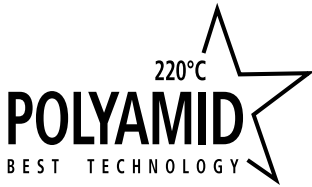

Das Profimaterial Polyamid besteht aus Nylon und Fiberglas. Hitzebeständig bis 220°C, extra hochwertige Profi-Qualität, gut geeignet für antihafbeschichtete Pfannen, ergonomischer Griff.

Polyamide is made of nylon and fiberglass. Heat-resistant up to 220°C, extra high quality, perfect for non-stick-coated pots and pans, ergonomic handle.

Poliamide de nylon y fibra de vidrio. Brevemente al calor hasta 220°, calta calidad profesional, ideal para sartenes antiadherentes, mango ergonómico.

Polyamide de nylon et fibre de verre, haute résistance brièvement à la chaleur jusque 220°C, qualité professionnelle, idéal pour les poêles antiadhérentes, manche ergonomique.



**Bratenwender**  
turner  
espátula  
spatule



	cm	Griff / handle cm
00603	11 x 9,5	23



**Pfannenwender**  
turner  
espátula  
spatule



	cm	Griff / handle cm
00600	11,5 x 9,5	23



**Pfannenwender**  
turner  
espátula  
spatule



	cm	Griff / handle cm
00604	15 x 7,5	15



**Pfannenwender**  
turner  
espátula  
spatule



	cm	Griff / handle cm
88642	13,5 x 9	18



**Pfannenwender**  
turner  
espátula  
spatule



	cm	Griff / handle cm
88640	13 x 6,5	15



**Servierlöffel**  
 serving spoon  
 cuchara de servicio  
 cuillère de service



	cm	Griff / handle cm	
88608	12 x 7	23	
00607	12 x 7	23	perforiert



**Schaumlöffel**  
 skimmer  
 espumadera  
 écumoire



	Ø cm	Griff / handle cm
00602	11,5	23



**Schöpflöffel**  
 ladle  
 cucharón  
 louche



	Ø cm	Griff / handle cm	ltr.
00606	9	23	0,1



**Toastzange**  
 sandwich tongs  
 pinzas para sandwich  
 pince à toasts



	cm	Griff / handle cm
00601	11 x 8	18



**Salatzange**  
 salad tongs  
 pinzas para ensalada  
 pince à salade



	cm	Griff / handle cm
00605	10 x 6	23



**Spaghettizange**  
 spaghetti tongs  
 pinzas para espaguetis  
 pince à spaghettis



	cm	Griff / handle cm
88637	9 x 9	15



**Salatzange „TIDLOS“**

salad tong  
pinza ensalada  
pince à salade

hochglanzpoliert, einseitig geschlitzt  
mirror polished, slotted on one side  
pulido brillante, agujereada en un lado  
poli brillant, perforée d'un seul côté



cm → cm  
75842 5 x 2 22



**Pastazange „TIDLOS“**

pasta tongs  
pinza espaguetis  
pince à spaghettis

hochglanzpoliert, beidseitig geschlitzt  
mirror polished, slotted on both side  
pulido brillante, agujereada en 2 lados  
poli brillant, perforéedes 2 côtés



cm → cm  
75843 8 x 5,5 22,5



**Spargelzange „TIDLOS“**

asparagus tongs  
pinzas para espárragos  
pince à asperges

hochglanzpoliert / mirror polished / pulido brillante / poli brillant



cm → cm  
75844 7 x 11 24,5



**Gebäckzange „TIDLOS“**

pastry tongs  
pinza para pasteles  
pince à gâteaux

hochglanzpoliert / mirror polished / pulido brillante / poli brillant



cm → cm  
75840 6,5 x 4,5 21



**Servierzange „TIDLOS“**

serving tongs  
pinza universal  
pince universelle

hochglanzpoliert / mirror polished / pulido brillante / poli brillant



cm → cm  
75841 7 x 4,5 21



**Salatzange**  
 salad serving tong  
 pinza de ensalada  
 pince à servir la salade

**hochglanzpoliert, einfache Handhabung**  
 mirror polished, convenient handling  
 pulido brillante, manejo cómodo  
 poli brillant, manipulation aisée



	cm	→ cm
00685	7,0 x 4,5	25



**Universalzange**  
 all - purpose tong  
 pinzas multiusos  
 pince multi-usages

**hochglanzpoliert, einfache Handhabung**  
 mirror polished, convenient handling  
 pulido brillante, manejo cómodo  
 poli brillant, manipulation aisée



	cm	→ cm
00688	7,0 x 4,5	25



**Brot- und Gebäckzange**  
 bread and pastry tong  
 pinza para pan y bollería  
 pince à pain ou viennoiseries

**hochglanzpoliert, einfache Handhabung**  
 mirror polished, convenient handling  
 pulido brillante, manejo cómodo  
 poli brillant, manipulation aisée



	cm	→ cm
00686	7,0 x 4,5	25



**Brot- und Gebäckzange**  
 bread and pastry tong  
 pinza para pan y bollería  
 pince à pain ou viennoiseries

**hochglanzpoliert, einfache Handhabung**  
 mirror polished, convenient handling  
 pulido brillante, manejo cómodo  
 poli brillant, manipulation aisée



	cm	→ cm
00687	7,0 x 4,5	25



**Universalzange**  
all-purpose tong  
pinza universal  
pince universelle



	cm	→ cm	Farbe / Colour	€
75825	7 x 5	22,5	vintage-look	
75830	7 x 5	25	mirror polished	
75831	7 x 5	25	gold-look	
75832	7 x 5	25	copper-look	



**Universalzange**  
all-purpose tong  
pinza universal  
pince universelle



**hochglanzpoliert, mit Befestigungsclip**  
mirror polished, with fastening clip  
pulido brillante, con clip de fijación  
poli brillant, avec clip de fixation

	→ cm	Farbe / Colour
75850	19,5	mirror polished
75851	19,5	copper-look
75852	19,5	gunmetal-look



**Zange kann an einer Schale befestigt werden**  
tongs can be attached to a bowl



**Eiszange**  
ice tongs  
pinzas para hielo  
pince de la glace



**hochglanzpoliert, mit Befestigungsclip**  
mirror polished, with fastening clip  
pulido brillante, con clip de fijación  
poli brillant, avec clip de fixation

	→ cm	Farbe / Colour
75853	20	mirror polished
75854	20	copper-look
75855	20	gunmetal-look

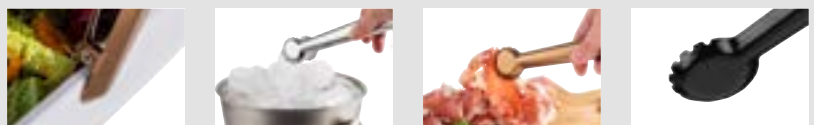

**Zange kann an einer Schale befestigt werden**  
tongs can be attached to a bowl





**Salatzange**

salad tong  
pinza ensalada  
pince à salade



hochglanzpoliert, beidseitig geschlitzt / mirror polished, slotted on both side  
pulido brillante, agujereada en 2 lados / poli brillant, perforéedes 2 côtés

	cm	→ cm
75801	5 x 2	24



**Universalzange**

all-purpose tong  
pinza universal  
pince universelle



Edelstahl, Antik-Edelstahl-Look / Vintage-Look

stainless steel, stainless antique look  
acero inoxidable, acero estilo antiguo  
acier inox, acier style antique

	cm	→ cm	Farbe / Colour
75823	5,5 x 5,0	20,0	vintage-look
75824	7,0 x 5,0	22,5	vintage-look



**Vorspeisenzange „BANQUET“**

appetizer tong  
pinza para aperitivos  
pince à apéritif



Vorderteil poliert, Stiel mattiert

front part: high-shiny, handle: matt-finish  
parte delantera pulida, asa mate  
partie avant polie, poignée matte

	cm	→ cm
75822	4,5 x 3,5	20



ideal für Vorspeisen  
ideal for starters



**Spaghettizange**

spaghetti tong  
pinza espaguetis  
pince à spaghetti



hochglanzpoliert, fugenlos

mirror polished, seamless  
pulido brillante, sin soldaduras  
poli brillant, monobloc

	cm	→ cm
75810	6 x 3	19



**Aufschnitt- / Allzweckzange**

sausage tong  
pinza salchichas  
pince à saucisses

hochglanzpoliert, fugenlos  
mirror polished, seamless  
pulido brillante, sin soldadura  
poli brillant, monobloc



	cm	→ cm
75806	3 x 2,5	16



**Allzweckzange**

multipurpose tong  
pinza multi-usos  
pince universelle multi-usages

hochglänzend, mit Feder und Verschlusschieber, dekorative Greiferform  
mirror polished, with spring and retaining clip, decorative gripper form  
pulido brillante, con muelle y cierre deslizante, gancho con forma decorativa  
poli brillant, avec mécanisme de verrouillage, forme de pince décorative



	cm	→ cm
88643	4 x 3	24
88644	4 x 3	30
88645	4 x 3	40



**Universalzange**

all - purpose tong  
pinza universal  
pince universelle

hochglanzpoliert, einseitig geschlitzt  
mirror polished, slotted on one side  
pulido brillante, agujereada en un lado  
poli brillant, perforée d'un seul côté



	cm	→ cm
75800	5 x 2	24



**Gebäckzange**

pastry tong  
pinza para pasteles  
pince à gâteaux

hochglanzpoliert, fugenlos, extra schwere Qualität  
mirror polished, seamless, extra heavy gauge  
pulido brillante, sin soldadura, alta calidad, resistente  
poli brillant, monobloc, qualité extra, robuste



	cm	→ cm
75807	8,5 x 4	27,5

**Gebäck- / Tortenzange**

pastry tong  
pinza para pasteles  
pince à gâteaux

hochglanzpoliert, fugenlos  
mirror polished, seamless  
pulido brillante, sin soldadura  
poli brillant, monobloc



	cm	→ cm
75803	7 x 3,5	17,5

**Gebäckzange**

pastry tong  
pinza para pasteles  
pince à gâteaux

hochglanzpoliert, perforiert  
mirror polished, perforated  
pulido brillante, perforado  
poli brillant, perforée



	cm	→ cm
75804	6,5 x 3	19,5

**Eisportionierer**

ice cream scoop  
cuchara para helado  
cuillère à glace

hochglanzpoliert, mit Edelstahlfeder (physikalisch bedingt nicht korrosionsbeständig)  
mirror polished, spring steel, spring is not stainless  
pulido brillante, muelle de acero especial, no resistente al óxido  
poli brillant, ressort acier spécial, non résistant à l'oxydation

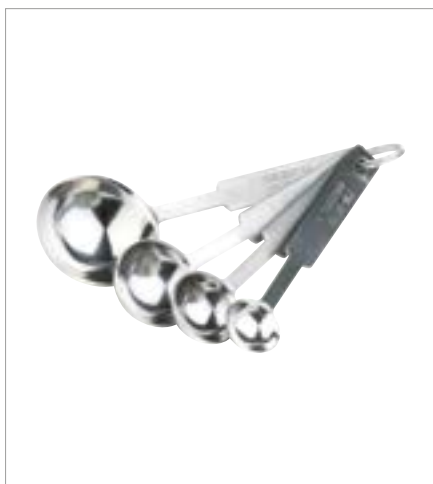

	Ø cm	→ cm	ltr.
71006	6,5	23,5	1/12
71005	6,0	22,5	1/16
71004	5,5	22,0	1/20
71003	5,0	22,0	1/24
71002	5,0	21,5	1/30
71001	4,5	21,0	1/36

**Messlöffelsatz**

set measuring spoon  
juego de cucharas medidoras  
jeu de cuillère à mesure

Löffel hochglanzpoliert, Stiele matt poliert, Skalierung:  
1 Esslöffel, 1 Teelöffel, 1/2 Teelöffel, 1/4 Teelöffel

bowl mirror polished, handles matt polished, measures:  
table spoon, tea spoon, 1/2 tea spoon, 1/4 tea spoon

bol medidor brillante, mango mate medidas:

1 cuchara de sopa, 1 cuchara de té, 1/2 cuchara de té, 1/4 cuchara de té

corps brillant, manche mat, mesures:

1 cuillerée à soupe, 1 cuillerée à thé, 1/2 cuillère à thé, 1/4 de cuillère à thé



	cm
75600	14 x 4,5

## TWEEZERS



### Pinzettenzange

fine tong / tweezer  
pinza de emplatar  
pinçe à dresser

**hochglanzpoliert, geriffelte Grifffläche, schwere Qualität**

mirror polished, ribbed handle, heavy gauge

pulido brillante, mango cómodo ranurado, alta calidad

poli brillant, manche rainuré antiglisse, qualité extra

EDELSTAHL  
STAINLESS  
INOX  
18/0



→ cm

75820

16



### Pinzettenzange

fine tong / tweezer  
pinza de emplatar  
pinçe à dresser

**hochglanzpoliert, geriffelte Grifffläche, schwere Qualität**

mirror polished, ribbed handle, heavy gauge

pulido brillante, mango cómodo ranurado, alta calidad

poli brillant, manche rainuré antiglisse, qualité extra

EDELSTAHL  
STAINLESS  
INOX  
18/0



→ cm

75821

30



### Pinzettenzange

fine tong / tweezer  
pinza de emplatar  
pinçe à dresser

**hochglanzpoliert, geriffelte Grifffläche, schwere Qualität**

mirror polished, ribbed handle, heavy gauge

pulido brillante, mango cómodo ranurado, alta calidad

poli brillant, manche rainuré antiglisse, qualité extra

EDELSTAHL  
STAINLESS  
INOX  
18/0



→ cm

75809

30



### Pinzettenzange

fine tong / tweezer  
pinza de emplatar  
pinçe à dresser

**hochglanzpoliert, geriffelte Grifffläche, abgerundete Spitzen vorne, schwere Qualität**

mirror polished, ribbed handle, rounded on the tops, heavy gauge

pulido brillante, mango cómodo ranurado, alta calidad, puntas redondeadas

poli brillant, manche rainuré antiglisse, qualité extra, pointes arrondies

EDELSTAHL  
STAINLESS  
INOX  
18/0



→ cm

75808

14,5



**Gourmetlöffel/-gabel, 6er Set**

tapas spoon / fork, 6 pcs.  
cuchara / tenedor de tapas, set de 6  
cuillère / fourchette à tapas, set de 6

**kann als Löffel oder Gabel verwendet werden**

can be used as a spoon or fork  
puede utilizarse como cuchara o tenedor  
peut être utilisé comme une cuillère ou une fourchette



	→ cm	pcs.
00699	10	6



**Feinkost- / Olivenlöffel, 6er Set**

delicatessen / olives spoon, 6 pcs.  
cuchara gourmet / para aceitunas, set de 6  
cuillère gourmet / à olives, set de 6

**gelocht**  
perforated  
perforadas  
perforées



	cm	→ cm	pcs.	Farbe / Colour
88598	6 x 9	27	6	■



**Feinkostlöffel, 6er Set**

delicatessen spoon, 6 pcs.  
cuchara gourmet, set de 6  
cuillère gourmet, set de 6

**aus Kunststoff**  
plastic  
plástico  
plastique



	Ø cm	→ cm	pcs.	Farbe / Colour
88627	6	23	6	■
88628	6	23	6	■



**Dressinglöffel**

dressing spoon  
cuchara de aliño  
cuillère à sauce

**aus Kunststoff**  
plastic  
plástico  
plastique



	Ø cm	→ cm	ltr.	Farbe / Colour
88636	6	34	0,05	■
88609	6	34	0,05	■



**Salatbesteck „OLIVE“, 2er Set**

spoon, 2 pcs.  
cuchara, set de 2  
cuillère, set de 2

aus Olivenholz

olive wood  
madera de olivo  
en bois d'olivier



	cm	→ cm
00841	9,5 x 8,5	17,0
00842	7,5 x 6,0	22,5



Anwendungsbeispiel  
application example



Anwendungsbeispiel  
application example



**Löffel „OLIVE“**

spoon  
cuchara  
cuillère

aus Olivenholz, ideal für Reis, Gemüse...

olive wood, ideal for rice, vegetables...  
madera de olivo, ideal para arroz, verduras...  
en bois d'olivier, idéal pour le riz, les légumes...



	cm	→ cm
00840	9,5 x 8,5	17,0



**Schaufel „OLIVE“**

scoop  
pala  
pelle

aus Olivenholz, ideal für Gewürze, Körner etc.

olive wood, ideal for spices, grains etc.  
madera de olivo, ideal para especias, granos etc.  
en bois d'olivier, idéal pour les épices, céréales, etc.



	→ cm
01020	13,5





**Löffel „OLIVE“, 2er Set**

spoon, 2 pcs.  
cuchara, set de 2  
cuillère, set de 2

aus Olivenholz, ideal für Gewürze  
olive wood, ideal for spices  
madera de olivo, ideal para especias  
en bois d'olivier, idéal pour les épices



	→ cm	pcs.
01018	14	2



**Honiglöffel „OLIVE“**

honey spoon  
cuchara de miel  
cuillère à miel

aus Olivenholz  
olive wood  
madera de olivo  
en bois d'olivier



	→ cm
01019	15



**Löffel „ACACIA“**

spoon  
cuchara  
cuillère

aus Akazienholz, ideal für Reis, Gemüse...  
acacia wood, ideal for rice, vegetables...  
madera de acacia, ideal para arroz, verduras...  
bois d'acacia, idéal pour le riz, les légumes...



	cm	→ cm
00599	9 x 6,5	23,5



**Schaufel**

scoop  
pala  
pelle

aus geöltem Eichenholz, mit Kunstlederband, ideal für Gewürze, Körner etc.  
made of oiled oak wood, with leatherette strap, ideal for spices, grains etc.  
de madera de roble aceitada, con correa de polipiel, ideal para especias, granos etc.  
en bois de chêne huilé, avec bracelet en simili-cuir, idéal pour les épices, céréales, etc.



	cm	↑ cm
01026	25,5 x 6	4,5



Anwendungsbeispiel  
application example



**Kugelausstecher - doppelt „ORANGE“**

melon baller - double  
vaciador doble de bola  
moule à boule double



zum Formen von Kugeln aus Obst, Gemüse oder Butter, Edelstahl mit geschärften Rändern  
to form balls out of fruits, vegetables, butter, etc., stainless steel with sharpened edge  
para hacer bolas con frutas, verduras, mantequilla, etc. acero inoxidable con borde afilado  
pour faire des boules de fruits, légumes, beurre, etc. inox, bord affûté

	∅ cm	→ cm
88810	2,2 + 2,5	16,5
88811	2,2 + 3,0	17



**Fadenschneider / Zester „ORANGE“**

decorator / zester  
cuchillo de decoración cincelador  
couteau zesteur



zum Abziehen von feinsten Schalenstreifen, ideal zum Dekorieren von Torten und Desserts  
to peel off very fine stripes of paring, these stripes are ideal to decorate desserts, cakes, etc.  
para pelar tiras muy finas, ideal para decorar postres, tartas, etc.  
pour couper en lanières fines, idéal pour la décoration de gâteaux et desserts, etc.

	∅ cm	→ cm
88823	0,2 + 0,5	14,5



**Ziseliermesser „ORANGE“**

canele / decorating knife  
cuchillo de decoración cincelador acanalado  
couteau zesteur cannelé



zum Einritzen von Linien und Mustern in hartschaliges Obst und Gemüse, Edelstahl mit geschärften Rändern  
to score lines or design in hard fruits and vegetables, stainless steel with sharpened edge  
para dibujar líneas en frutas o verduras de piel dura, acero inoxidable con borde afilado  
pour découper des lignes et motifs sur fruits et légumes à peau dure ou pour peler les zestes des citrons ou oranges, inox, bord affûté

	→ cm
88826	15



**Sparschäler „ORANGE“**

peeler  
pelador  
peleur



für Links- und Rechtshänder geeignet, mit zwei starren Klingen aus extra geschärftem + gehärtetem Edelstahl  
useable left- and right handed, with 2 inflexible blades made out off sharpened, extra hardened stainless steel  
para diestros y zurdos, con 2 cuchillas rígidas inox afiladas y muy resistentes  
pour gauchers ou droitiers, 2 lames rigides affûtés en inox extra-résistant

	→ cm
88827	17



**Pendelschäler „ORANGE“**

swivel peeler  
pelador reversible  
éplucheur droitier/gaucher

für Links- und Rechtshänder, ideal für das Schälen von Tomaten, mit 2 beweglichen Klingen

suitable for right and left handed, ideal to peel tomatoes, with 2 flexibles blades

apto para diestros y zurdos, ideal para pelar tomates, con 2 hojas flexibles

pour gauchers ou droitiers, idéal pour peler les tomates, 2 lames flexibles



→ cm

88850

16,5

**Cocktailmesser „ORANGE“**

bar knife  
cuchillo para cóctel  
couteau cocktail

mit 2 Zinken zum Aufspießen von Zitrusseiben

with 2 prongs to pick up slices of lemon

con 2 dientes para pinchar las rodajas de limón, etc.

avec 2 dents pour les rondelles de citron et autres décorations



→ cm

88846

21

**Pizzateigschneider „ORANGE“**

pizza cutter  
cortador de pizza  
roulette à pizza

zum einfachen Zerteilen von Pizza

to cut pizza easily

para cortar pizza fácilmente

pour une coupe facile de la pizza



∅ cm → cm

88829

6

18,5

**Pendelschäler „ORANGE“**

swivel peeler  
pelador lama pivotante  
peleur lame pivotante

zum schnellen und sparsamen Schälen von Obst und Gemüse, mit beweglicher Klinge

to peel fruits and vegetables with flexible blade

para pelar frutas y verduras con hoja flexible

pour couper des fruits et légumes avec lame flexible



→ cm

88834

17

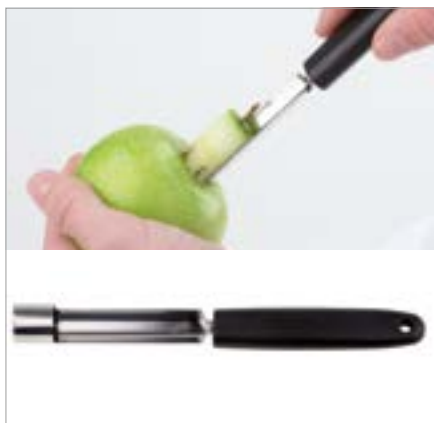
**Apfelentkerner „ORANGE“**

apple corer  
descorazonador de manzana  
vide-pomme

durch leichtes Drehen kann das Kerngehäuse von Äpfeln, Birnen und anderen Früchten sorgsam herausgeholt werden, Edelstahl mit geschärften Rändern

with a light turn cores of apples, pears and other fruits

can be cut off easily, stainless steel with sharpened edge

para descorazonar muy fácilmente manzanas, peras y otras frutas

pour évider facilement les pommes, poires ou autres fruits



∅ cm → cm

88836

2,2

21



**Austernöffner „ORANGE“**

oyster knife  
 abre ostras  
 couteau à huîtres



zum einfachen Aufbrechen von Austern, mit Fingerschutz, Edelstahl mit geschärften Rändern  
 to open oysters easily, with guard, stainless steel with sharpened edge  
 para abrir ostras fácilmente con protección para los dedos, acero inoxidable con punta afilada  
 pour ouvrir facilement les huîtres avec protection pour les doigts, inox, pointe affûtée

→ cm

88839 14,5



**Austernmesser „ORANGE“**

oyster knife  
 abre ostras  
 couteau à huîtres



Edelstahlklinge zum Einstechen in die Schale, mit Fingerschutz

to open oysters easily, with guard  
 para abrir ostras fácilmente con protección para los dedos  
 pour ouvrir facilement les huîtres avec protection pour les doigts

→ cm

88840 15



**Dekoriermesser „ORANGE“**

decorating knife „cannelé“  
 cuchillo acanalador  
 couteau cannelé



gezahnte Klinge aus geschärftem Edelstahl  
 serrated sharpened blade, stainless steel  
 hoja de sierra afilada, acero inoxidable  
 lame inox microdentée

→ cm

88843 19



**Käsehobel „ORANGE“**

cheese slicer  
 rebanador de queso  
 couteau tranche-fromage



zum Schneiden von dünnen Käsescheiben

to cut thin slices of cheese  
 para cortar lonchas finas de queso  
 pour couper de fines tranches de fromage

→ cm

88853 21,5



### Streichpalette „BLUE“

spatula  
espátula  
spatule



**flexible Edelstahlklinge, rutschfester Griff, hitzebeständig**

flexible blade stainless steel, non-slip handle, heat-resistant

hoja flexible acero inoxidable mango polipropileno termoresistente anti-deslizante

lame inox flexible, manche antiglisse en polypropilène thermorésistant

	cm	→ cm
88920	35 x 5	48,5
88921	30,5 x 4,5	43,5
88922	25 x 4	38,0
88923	20 x 3	33,5



### Winkelpalette „BLUE“

spatula  
espátula  
spatule



**flexible Edelstahlklinge**

flexible blade stainless steel

hoja flexible acero inoxidable

lame inox flexible

	cm	→ cm
88928	17 x 5	30



### Gebäckpalette „BLUE“

pastry spatuala  
paleta pastelera  
spatule pâtissière



**flexible Edelstahlklinge**

flexible blade stainless steel

hoja flexible acero inoxidable

lame inox flexible

	cm	→ cm
88932	17 x 7,5	29,5



### Wender „BLUE“

turner  
espátula  
spatule



**flexible Edelstahlklinge**

flexible blade stainless steel

hoja flexible acero inoxidable

lame inox flexible

	cm	→ cm
88933	15 x 6	27,5



**Winkelpalette „BLUE“**

turner  
espátula  
spatule

**flexible Edelstahlklinge**  
flexible blade stainless steel  
hoja flexible acero inoxidable  
lame inox flexible



	cm	→ cm
88935	34 x 5	47,5
88937	24 x 4	36
88938	18,5 x 3	32



**Wender „BLUE“**

turner  
espátula  
spatule

**flexible Edelstahlklinge**  
flexible blade stainless steel  
hoja flexible acero inoxidable  
lame inox flexible



	cm	→ cm
88939	24 x 7,5	37,5



**Wender „BLUE“**

turner  
espátula  
spatule

**perforiert, flexible Edelstahlklinge**  
perforated, flexible blade stainless steel  
hoja flexible inox agujereada  
lame ajourée inox flexible



	cm	→ cm
88940	24,5 x 7,5	37,5



**Wender „BLUE“**

turner  
espátula para plancha  
spatule

**flexible Edelstahlklinge**  
flexible blade stainless steel  
hoja flexible acero inoxidable  
lame inox flexible



	cm	→ cm
88941	20 x 7,5	33
88942	15 x 9	28



**Spachtel / Schaber „BLUE“**

scraper  
 espátula plancha  
 spatule coudée spéciale grill  
**starre Edelstahlklinge**  
 rigid blade stainless steel  
 hoja rígida acero inoxidable  
 lame inox rigide



	cm	→ cm
88929	11 x 10	25



**Spachtel / Fettabstecher „BLUE“**

scraper  
 espátula plancha  
 spatule coudée spéciale grill  
**starre Edelstahlklinge**  
 rigid blade stainless steel  
 hoja rígida de acero inoxidable  
 lame rigide inox



	cm	→ cm
88946	17 x 10	30
88947	15 x 7,5	28



**Aufstrichmesser „BLUE“**

sandwich knife  
 cuchillo para untar  
 couteau à tartiner  
**flexible Edelstahlklinge**  
 flexible blade stainless steel  
 hoja flexible acero inoxidable  
 lame inox flexible



	cm	→ cm
88948	8,5 x 3	18,5



**Teigschaber / Abstecher „BLUE“**

dough scraper  
 corta pasta  
 coupe-pâte  
**starre Edelstahlklinge**  
 rigid blade stainless steel  
 hoja rígida de acero inoxidable  
 lame rigide inox



	cm
88930	15,5 x 8



**Pizzaschneider „BLUE“**

pizza cutter  
cortador de pizza  
coupe-pizza

ergonomischer Griff  
ergonomic handle  
mango ergonómico  
manche ergonomique



	Ø cm	→ cm
88949	10	20



**Eierschneider**

egg cutter  
corta huevos  
coupe-oeufs

zum Längs- und Querteilen von hart gekochten Eiern  
to cut hard-boiled eggs  
corta a rodajas un huevo duro  
en rondelles



	cm	↑ cm
88099	14,5 x 8	2,5



**Hummerbrecher**

lobster cracker  
pinza bogavante  
pince à homard



	cm
74201	14 x 5,5



**Schneebeesen**

whisk  
batidor  
fouet



	Drähte / wires	→ cm
00744	8	28
00745	8	33
00746	8	38
00747	8	43
00740	8	48

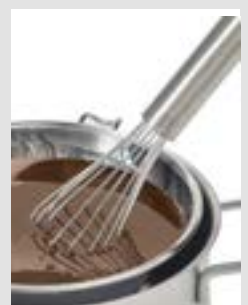



**Passiersieb**

strainer  
colador  
passoire



**feines Siebgewebe mit ca. 6 Löchern pro 1 cm<sup>2</sup>**

fine mesh with 6 holes per 1 cm<sup>2</sup>

malla fina con 6 agujeros por 1 cm<sup>2</sup>

toile fine avec 6 trous pour 1 cm<sup>2</sup>

	Ø cm	→ cm
88618	30,0	60,0
88639	33,5	62,5



**Passiersieb**

strainer  
colador  
passoire



**feines Siebgewebe mit ca. 6 Löchern pro 1 cm<sup>2</sup>**

fine mesh with 6 holes per 1 cm<sup>2</sup>

malla fina con 6 agujeros por 1 cm<sup>2</sup>

toile fine avec 6 trous pour 1 cm<sup>2</sup>

	Ø cm	→ cm
74700	14	30
74701	16	32
74702	18	34
74703	20	36
74705	24	41
74706	26	43



**Passiersieb**

strainer  
colador  
passoire



**mit Doppelnetz, Netz außen: ca. 2 Löcher pro 1 cm, Netz innen: ca. 5 Löcher pro 1 cm**

with double mesh, outer mesh about 2 holes per cm, inner mesh about 5 holes per cm

con malla doble, malla exterior aprox. 2 agujeros /cm, interior aprox. 5 agujeros /cm

avec double étamine, extérieure env. 2 trous/cm, intérieure environ 5 trous/cm

	Ø cm	→ cm
74721	19,5	41,0
74722	24,5	56,5



## STRAINERS

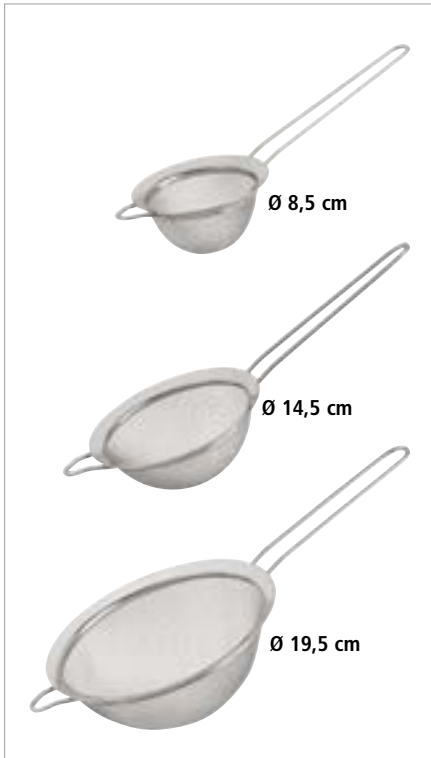

### Passiersieb, 3er Set

strainer, 3 pcs.  
colador, set de 3  
passoire, set de 3



3-teiliges Set bestehend aus 3 Sieben:

Ø 8,5 cm, L: 22,5 cm / Ø 14,5 cm, L: 32 cm / Ø 19,5 cm, L: 38,5 cm

set of 3 consisting of 3 sieves:

Ø 8,5 cm, L: 22,5 cm / Ø 14,5 cm, L: 32 cm / Ø 19,5 cm, L: 38,5 cm

set de 3 que consta de 3 tamices:

Ø 8,5 cm, L: 22,5 cm / Ø 14,5 cm, L: 32 cm / Ø 19,5 cm, L: 38,5 cm

set de 3 composé de 3 tamis :

Ø 8,5 cm, L: 22,5 cm / Ø 14,5 cm, L: 32 cm / Ø 19,5 cm, L: 38,5 cm

	Ø cm	→ cm
74707	8,5/14,5/19,5	22,5/33/38,5



3 teilig  
3 pcs. set



### Barsieb

bar strainer  
colador de cóctel  
tamis cocktail



	Ø cm	↑ cm	Griff / handle cm
93318	8,5	5	11,5



### Gazespitzsieb

conical strainer with wire gauze  
colador chino de malla  
chinois renforcé avec maille fine



hochglanzpoliert, mit rundem Hohlgriff, ca. 9 Löcher pro 1 cm<sup>2</sup>

mirror polished, 9 holes per 1 cm<sup>2</sup>

pulido brillante, mango hueco, 9 agujeros por 1 cm<sup>2</sup>

poli brillant, manche creux, 9 trous pour 1 cm<sup>2</sup>

	Ø cm	↑ cm	Griff / handle cm
88717	25	19	24



### Spitzsieb

conical strainer  
colador cónico  
chinois



mit Lochung Ø 1,5 mm, auch in der Kegelspitze, mit Flachstiel, mit Stützstiel zum Einhaken in den Topfrand

with Ø 1,5 mm holes (including the tip), with flat handle, with supporting hook

con agujeros finos de Ø 1,5 mm (incluída la punta), con mango plano y gancho

perforations fines 1,5 y compris à la pointe, manche plat et crochet

	Ø cm	↑ cm	Griff / handle cm
00771	23	18	16,5





**Seiher**  
strainer  
colador  
passoire



	Ø cm	↑ cm
74708	28,5	10



**Seiher**  
strainer  
colador  
passoire



**mit 2 Muschelgriffen**  
with 2 shell shaped grips  
con dos asas  
à 2 anses moulées

	Ø cm	↑ cm
00780	36	19



**Pommes-Frites-Seiher**  
fry dripping tray  
escurridor de fritos  
égouttoir à friture



**herausnehmbarer Locheinsatz, mit Handgriff**  
removable drainer, with handle  
fondo de colador desmontable, con asa  
fond démontable, avec poignée

	Ø cm	↑ cm
00785	39	19



**Salzstreuer**  
salt shaker  
salero  
salière



**Pommes-Frites Streuer mit Schraubkappe**  
for french fries, cover to screw  
para patatas fritas, tapa de rosca  
pour les frites, couvercle à visser

	Ø cm	↑ cm	
00772	8	17	stainless steel
00779	8	17	aluminium



**Back- / Frittierlöffel**  
skimmer / spider  
espumadera para fritos  
écumoire à friture



**elektropoliert, sehr stabile Ausführung**  
electro polished, heavy gauge  
electro pulido, alta calidad  
poli électrolythique, qualité extra

	Ø cm	→ cm
74402	16	48
74404	20	54



**Wasserbadschüssel**  
 bain marie bailing bowl  
 cazo para baño maría  
 récipient bain-marie



**hochglanzpoliert, mit Drahtgriff Ø 5 mm**  
 mirror polished, with wire handle Ø 5 mm  
 pulido brillante, mango varilla Ø 5 mm  
 poli brillant, manche fil épaisseur Ø 5 mm

	Ø cm	↑ cm	Griff / handle cm	litr.
74731	18	9	15	1,5



**Anwendungsbeispiel, Topf ≥ 20 cm**  
 Application Example, pot ≥ 20 cm



**Saucen- und Fondantrichter**  
 sauce and confectionary funnel  
 embudo para salsa y confitería  
 entonnoir à sauce et confiserie



**ergonomischer Griff, Maßskalierung innen, mit 3 Düsen Ø 4, 5, 6 mm, inklusive Ständer und Auffangschale**

ergonomic handle, scaling inside, with 3 different nozzles Ø 4, 5, 6 mm, including wire rack a. dripping dash  
 mango ergonómico, escalado interior, con 3 boquillas, Ø 4, 5, 6 mm, incl. pie de alambre y bandeja recoge gotas  
 manche ergonomique, mise à l'échelle à l'intérieur, 3 douilles de Ø 4, 5 et 6 mm, inclut pied avec ramasse-gouttes

	Ø cm	↑ cm	litr.
77338	21	31,5	1,5



**Anwendungsbeispiel**  
 application example

**Maßskalierung innen**  
 scaling inside



**Gemüsehobel, Mandoline**  
 mandolin  
 mandolina  
 mandoline



**mit 7 verschiedenen Klingen (Breite 10 cm), Anti-Rutsch-Gestell, Schutzabdeckung**  
 with 7 interchangeable blades (width 10 cm), non-slip folding stand, safety guard  
 con 7 cuchillas intercambiables (corte 10 cm), pie plegable anti-deslizante, carro de seguridad  
 7 peignes interchangeables (largeur 10 cm), pied repliable anti-glisse, chariot

	cm	↑ cm
88688	40,5 x 12	5 / 25

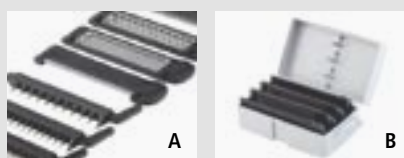

**A 7 verschiedene Klingen**  
 7 interchangeable blades  
**B Praktische Transportbox**  
 Practical transport box



**Messbecher**  
graduated jug  
jarra graduada  
pichet gradué



**außen hochglanzpoliert, innen matt poliert, mit Maßskalierung außen**  
outside mirror polished, inside matt polished, with stamped liter scale  
exterior pulido brillante, interior pulido mate con escalado en litros  
extérieur poli brillant, intérieur poli mat, graduation en litres

	Ø cm	↑ cm	ltr.
30045	10	14	1

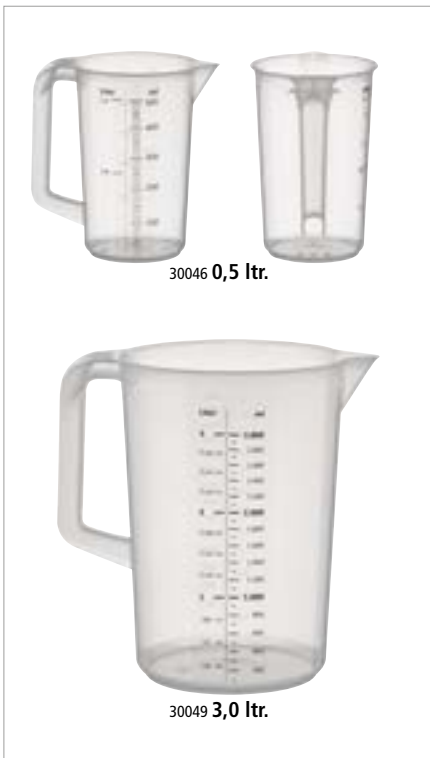

**Messbecher „PRO“**  
measuring cup  
jarra graduada  
pichet gradué



**mit geschlossenem Griff, mit geprägter Maßskalierung außen, l- und ml-Liter-Einteilung**  
with closed handle, with stamped printed liter and ml scale  
con asa cerrada, con escala estampada de litros y ml  
avec poignée fermée, avec échelle en litres et ml imprimée et tamponnée

	Ø cm	↑ cm	ltr.
30046	9	14	0,5
30047	12	16,5	1,0
30048	15	20,5	2,0
30049	17	23,5	3,0
30057	20	25,5	5,0



**einfaches Eingießen**  
easy pouring



**Messbecher „STACKABLE“**  
measuring cup  
jarra graduada  
pichet gradué



**mit offenem Griff und geprägter Maßskalierung außen, platzsparend stapelbar**  
with open handle and embossed dimension scaling on the outside, space-saving stackable  
con asa abierta y escala de dimensiones en relieve en el exterior, apilable para ahorrar espacio  
avec une poignée ouverte et une échelle de dimensions en relief à l'extérieur, empilable et peu encombrante

	Ø cm	↑ cm	ltr.
30059	7	12	0,25
30061	9	14	0,5
30062	12	16,5	1,0
30063	15	20,5	2,0



**offener Griff**  
open handle

**einfaches Eingießen**  
easy pouring

**stapelbar**  
stackable



1 ltr.

inkl. Spritzschutz / incl. splash guard

**Rührbecher mit Deckel**

stirring cup with lid  
vaso agitador con tapa  
tasse à remuer avec couvercle



**inklusive Spritzschutz und geprägter Maßskalierung außen, platzsparend stapelbar**

included splash guard with open handle and embossed dimension scaling on the outside, space-saving stackable

protección contra salpicaduras incluida con asa abierta y escala de dimensiones en relieve en el exterior, apilable para ahorrar espacio

protection contre les éclaboussures incluse avec une poignée ouverte et une échelle de dimensions en relief à l'extérieur, empilable et peu encombrante

	Ø cm	↑ cm	ltr.
30058	12,5	16	1,0



**Griff mit Daumenmulde**  
handle with thumb recess



**mit Silikonring**  
with silicone ring



**Schaumspeisering**

mousse ring  
aro redondo para semifríos  
cercle à mousse rond

**matt poliert, fugenlos**  
matt polished, seamless  
pulido mate, sin soldadura  
poli mat, sans soudure



	Ø cm	↑ cm
00098	6	4,5
00099	7	4,5
00092	8	4,5
00093	10	4,5
00094	12	4,5



00110

**Schaumspeiseringe, 5er Set**

mousse ring, 5 pcs.  
juego aros para emplatar o para semifríos  
jeu de cercles à mousse inox, ronds

**5-teilig: 4 Formen + 1 Verdichter, matt poliert, fugenlos**  
5 pcs. set: 4 shapes and 1 pusher, matt polished, seamless

juego de 5 piezas: 4 aros redondos y 1 pulsador, para dar forma, satinado sin soldadura  
jeu de 5 pièces: 4 cercles et 1 poussoir. Idéal pour dressage sur assiette ou mousse, poli mat, sans soudure



	Ø cm	↑ cm	pcs.
00110	6	4,5	5
00113	8	4,5	5



**Dariolformen, 2er Set**

dariol moulds, 2 pcs.  
juego 2 flaneras  
jeu de 2 moules à flan

hochglanzpoliert  
mirror polished  
pulido brillante  
poli brillant



	Ø cm	↑ cm	ltr.	pcs.
00106	6,5	4,5	0,1	2



**Tortenring**

cake setting ring  
aro de tarta  
cercle à gâteaux

stufenlos verstellbar, ohne Griff  
adjustable, without handle  
ajustables, sin asa  
ajustables, sans poignée



	Ø cm	↑ cm
00040	16,5 - 32	7



Anwendungsbeispiel  
application example



**Backform**

baking pan  
marco pastelero  
forme à gateaux

stufenlos verstellbar, aus flexiblem Edelstahl  
adjustable, made of flexible stainless steel  
ajustable, de acero inoxidable flexible  
ajustable, en acier inox flexible



	cm	↑ cm
00042	19 x 28 - 34 x 54	5



Anwendungsbeispiel  
application example



**Ausstellblech / Thekenblech**

display tray  
bandeja pastelera  
plaque pâtissière

hitzebeständig bis 230°C  
heat-resistant up to 230°C  
resistente al calor hasta 230 °C  
résistant à la chaleur jusqu'à 230°C



	cm	↑ cm
13377	40 x 25	2
13378	48 x 32	2
13379	60 x 40	2



**Profi-Eimer**

bucket  
cubo  
seau



mit Ausgießer und geprägter Maßskalierung innen  
with spout and embossed dimension scaling inside  
con pico y escala de medición en relieve en el interior  
avec bec verseur et échelle de mesure en relief à l'intérieur

	Ø cm	↑ cm	ltr.	Farbe / Colour
30075	28,5	28,5	10,5	White
30076	33,0	32,0	17,0	White
30077	28,5	28,5	10,5	Black
30078	33,0	32,0	17,0	Black



mit Griff  
with handle



Maßskalierung innen  
dimension scaling inside



Auslaufnase für sicheres Handling  
discharge nose for safe handling



**Mehlschaufel „PRO“**

scoop  
pala  
pelle à farine



stehende Schaufel, auch für Flüssigkeiten geeignet  
standing scoop, also applicable for liquids  
pala, ápto también para líquidos  
adaptée pour poudres et liquides

	cm	↑ cm	ltr.	Farbe / Colour
00610	25 x 9	4,5	0,25	White
00611	31 x 12	5,5	0,5	White
00612	35 x 13	6	0,7	White



**Schaufel „ECO“**

scoop  
pala  
pelle



stabil und bruchsicher  
stable and unbreakable  
estable e irrompible  
stable et incassable

	→ cm	ltr.
00694	18	0,110
00695	24	0,230
00696	31	0,470
00697	33	0,725



Zum schnellen und zielgerichteten Abfüllen von Lebensmitteln  
for fast and targeted filling of foodstuffs



30065 Ø 6 cm

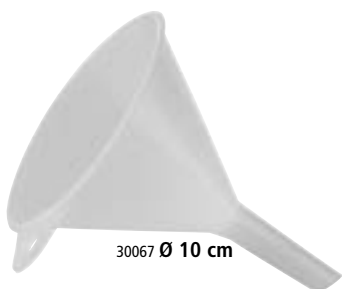

30067 Ø 10 cm



30068 Ø 12 cm



mit Sieb  
with strainer

30070 Ø 17 cm



mit Sieb  
with strainer

30071 Ø 21 cm

Trichter „PROFI“

funnel  
embudo  
entonnoir

mit Öse  
with eyelet  
con ojal  
avec œillet



	Ø cm	Ø mm Durchlass	
30065	6	8	
30066	8	11	
30067	10	12	
30068	12	12	
30069	14	15	
30070	17	17	mit Sieb / with strainer
30071	21	20	mit Sieb / with strainer



erleichtert das Einfüllen  
facilitates filling

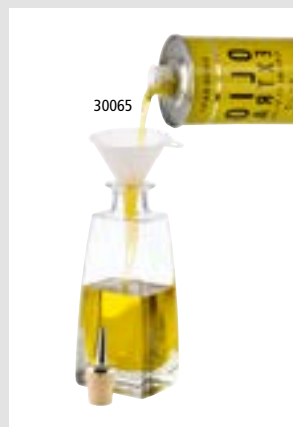

Anwendungsmöglichkeit  
applicability



mit einsetzbarem Sieb  
with insertable strainer



mit einsetzbarem Sieb  
with insertable strainer



**Limetten- / Zitronenpresse**

lime- / lemonpress  
 exprimidor de limón / lima  
 presse citron

**2 Pressringe für Zitrone und Limette**

2 squeezing rings for lemon and lime  
 2 anillos exprimidores para limón y lima  
 2 anneaux à presser pour le citron et le lime



	cm	↑ cm
93214	21 x 7	5



**Limettenpresse**

lime press  
 prensa de limón  
 presse citron



	cm	↑ cm
93189	21 x 7	5



**Zitruspresse**

citrus squeezer  
 exprimidor cítricos  
 presse-citron

**hochglanzpoliert, 2-teilig**

mirror polished, 2 pcs.  
 pulido brillante, 2 piezas  
 poli brillant, 2 pièces



	Ø cm	↑ cm	ltr.
71431	12 / 17	10,5	0,35



**Pinsel**

brush  
 brocha  
 pinceau pâtissier

**weißgebleichte, naphthalinfreie Borsten, temperaturbeständig von -40°C bis +95°C**

bleached bristles, heat-resistant from -40°C to +95°C  
 cerdas blanqueadas, resistencia térmica -40°C hasta +95°C  
 soies blanchies sans naphthaline, résistance de -40°C à +95°C



	cm	→ cm
77350	4 x 1	23,5



**Panierstation, 3-teilig**

breading set, 3 pcs. set  
 estación de empanado, set de 3  
 station de panure, set de 3

**zum Panieren von Fleisch, Gemüse, Käse etc.**

for breading meat, vegetables, cheese etc.  
 para empanar carne, verduras, queso, etc.  
 pour paner la viande, les légumes, le fromage etc.



	cm	↑ cm
66904	45,5 x 18	2,5







**Bonspieß**  
bill spike  
pinchanotas  
pique-bons



**Spieße aus flexiblem Kunststoff, mit stumpfen Enden zur Unfallverhütung**  
spikes made of flexible plastic, with blunt ends to prevent accidents  
pinchos de plástico flexible  
piques en plastique flexible

	cm	↑ cm
88855	9 x 5,5	10,5



**Bonleiste**  
bill rail  
portafichas  
barre porte-bons



**matt poliert, mit Kugel-Greifsystem, zur Wandmontage geeignet, auch mit Magneten nutzbar**  
matt polished, small balls hold the bills, suited for wall fastening, can also be used with magnets  
pulido mate, con sistema de bolas para colgar las notas para fijar en la pared, puede usarse con imán  
poli mat, avec billes pour fixer sans effort tous types de fiches et papiers, peut se fixer sur plaque aimantée

	cm	↑ cm
88900	40 x 8	2
88901	50 x 8	2
88902	60 x 8	2



**Magnet-Messerhalter**  
magnetic knife rack  
barra magnética para cuchillos  
barre aimantée pour couteaux



**mit 2 Magnetschienen und Haken, aus massivem Kunststoff, zur Wandmontage geeignet, Lieferung ohne Deko**  
with 2 magnet racks and hooks, strong plastic, suited for wall fastening  
con 2 railes magnéticos y ganchos, plástico macizo, fijación en pared  
avec 2 rails aimantés et crochets, plastique robuste, fixation murale

	→ cm
88911	45
88912	60



**Folien-Abreißvorrichtung**  
clingfilm tear-off-dispenser  
dispensador de film  
dérouleur de film



**mit Abreißkante / Säge-Messer, für Endlosfolie, als Tischgerät oder Wandgerät verwendbar**  
with saw, for endless rolls, can be fixed on the wall  
con sierra para rollo de film continuo, se puede fijar en la pared  
avec lame dentée pour rouleau de film, peut être fixé au mur

	cm	↑ cm	
88288	34 x 16	9	für Folienbreite 30 cm / for film width 30 cm para film ancho 30 cm / pour film largeur 30 cm
88287	49 x 16	9	für Folienbreite 45 cm / for film width 45 cm para film ancho 45 cm / pour film largeur 45 cm



**Schneidbrettständer**

cutting board rack  
soporte para tablas  
rack pour planches à découper

**für 6 Schneidbretter bis 25 mm Stärke, Lieferung ohne Deko**  
for 6 chopping boards up to 25 mm thickness  
para 6 tablas de corte de 25 mm  
pour 6 planches de 25 mm



	cm	↑ cm
88903	27 x 31	28



**Eiswaffel-Ständer**

cornet stand  
soporte cucuruchos  
support à cornets

**matt poliert, mit 4 Löchern, 2 x Ø 31 mm + 2 x Ø 26 mm**  
matt polished, with 4 holes, 2 x Ø 31 mm + 2 x Ø 26 mm  
pulido mate, con 4 agujeros 2 x Ø 31 mm + 2 x Ø 26 mm  
poli mat, 4 trous - 2 x Ø 31 mm + 2 x Ø 26 mm



	cm	↑ cm
11881	27,5 x 9,5	9



**Eisportionierer**

ice cream scoop  
cuchara para helado  
cuillère à glace

**hochglanzpoliert, mit Edelstahlfeder (physikalisch bedingt nicht korrosionsbeständig)**  
mirror polished, spring steel, spring is not stainless  
pulido brillante, muelle de acero especial, no resistente al óxido  
poli brillant, ressort acier spécial, non résistant à l'oxydation



	Ø cm	→ cm	ltr.
71006	6,5	23,5	1/12
71005	6,0	22,5	1/16
71004	5,5	22,0	1/20
71003	5,0	22,0	1/24
71002	5,0	21,5	1/30
71001	4,5	21,0	1/36

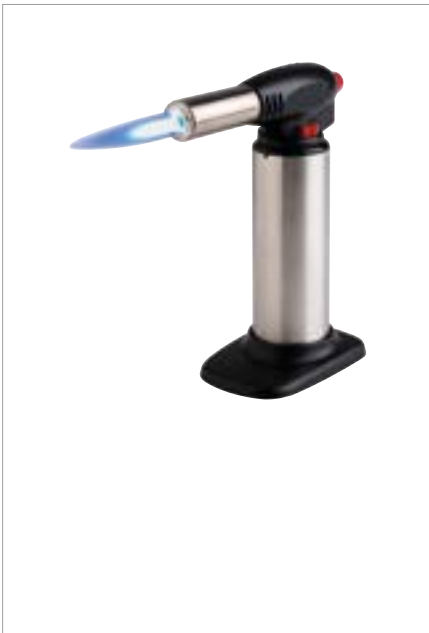

**Flambierbrenner**

chefs blow torch  
soplete de cocina para flambear  
chalumeau de cuisine

**mit handelsüblichem Feuerzeuggas auffüllbar, Flamme einstellbar bis ca. 1300° C, Brenndauer von mindestens 60 Minuten**

to be filled with commercial lighter gas, flame adjustable up to approx. 1300° C, burning time of at least 60 minutes

rellenable con gas de mechero comercial, llama ajustable hasta 1300 ° C, tiempo de combustión de al menos 60 minutos

rempli avec gaz pour briquet commercial, flamme réglable jusqu'à 1300 ° C, temps de combustion d'au moins 60 minutes



	Ø cm	↑ cm
77315	4,5	16,5



Anwendungsbeispiel  
application example

# SQUEEZE BOTTLES



## Quetschflasche

squeeze bottle  
bote dosificador flexible  
bouteille verseuse souple



mit Schraubdeckel und Verschlusskappe, ideal für Dressing und Saucen

with tight-screw and cap, ideal for dressing and sauce

con tapa de rosca y tapón, ideal para aliño y salsas

avec couvercle à visser et bouchon de fermeture, idéal pour vinaigrette et sauces

	Ø cm	↑ cm	ltr.	Farbe / Colour
93259	8	26,5	1,025	White
93260	8	26,5	1,025	Yellow
93261	8	26,5	1,025	Red



große „Öffnung“  
big „mouth opening“



## Quetschflasche

squeeze bottle  
bote dosificador flexible  
bouteille verseuse souple



mit Schraubdeckel und Verschlusskappe, ideal für Dressing und Saucen

with tight-screw and cap, ideal for dressing and sauce

con tapa de rosca y tapón, ideal para aliño y salsas

avec couvercle à visser et bouchon de fermeture, idéal pour vinaigrette et sauces

	Ø cm	↑ cm	ltr.	Farbe / Colour
93155	6,5	24	0,65	Yellow
93156	6,5	24	0,65	Red
93157	6,5	24	0,65	White



## Quetschflasche „MINI“, 4er Set

squeeze bottle, 4 pcs.  
bote dosificador flexible, 4 pz.  
bouteille verseuse souple, 4 pc.



mit Schraubdeckel und Verschlusskappe, ideal für Dressing und Saucen

with tight-screw and cap, ideal for dressing and sauce

con tapa de rosca y tapón, ideal para aliño y salsas

avec couvercle à visser et bouchon de fermeture, idéal pour vinaigrette et sauces

	Ø cm	↑ cm	ltr.	pcs.
93225	3,0	8,5	0,03	4
93226	3,5	9,5	0,05	4

## SQUEEZE BOTTLES



### Quetschflasche, 6er Set

squeeze bottle, 6 pcs.  
bote dosificador flexible, set de 6  
bouteille verseuse souple, set de 6



mit Schraubdeckel und Verschlusskappe, ideal für Dressing und Saucen

with tight-screw and cap, ideal for dressing and sauce

con tapa de rosca y tapón, ideal para aliño y salsas

avec couvercle à visser et bouchon de fermeture, idéal pour vinaigrette et sauces

	Ø cm	↑ cm	ltr.	Farbe / Colour	pcs.
93250	5	18,0	0,26		6
93251	5	18,0	0,26		6
93252	5	18,0	0,26		6
93253	7	20,0	0,49		6
93254	7	20,0	0,49		6
93255	7	20,0	0,49		6
93256	7	26,5	0,76		6
93257	7	26,5	0,76		6
93258	7	26,5	0,76		6



mit Verschlusskappe  
with cap



große „Öffnung“  
big „mouth opening“



### Quetschflasche „NON DRIP“

squeeze bottle  
bote dosificador flexible  
bouteille verseuse souple



mit Schraubdeckel und Verschlusskappe, ideal für Dressing und Saucen

with tight-screw and cap, ideal for dressing and sauce

con tapa de rosca y tapón, ideal para aliño y salsas

avec couvercle à visser et bouchon de fermeture, idéal pour vinaigrette et sauces

	Ø cm	↑ cm	ltr.	Farbe / Colour
93270	5,5	21,0	0,35	
93271	5,5	21,0	0,35	
93272	5,5	21,0	0,35	
93273	7,0	25,5	0,75	
93274	7,0	25,5	0,75	
93275	7,0	25,5	0,75	



mit Skalierung  
with scaling



tropffrei  
non drip



### Quetschflasche

squeeze bottle  
bote dosificador flexible  
bouteille verseuse souple



ideale Größe, um Speiseteller mit Saucen zu verzieren, mit Verschlusskappe

ideal size to garnish plates with sauces, with cap

tamaño ideal para decorar platos con salsas, con tapón

taille idéale pour décorer assiettes avec des sauces, avec bouchon

	Ø cm	↑ cm	ltr.
93154	5	16	0,2
93163	6	21	0,35



### Dosierspender

dispenser  
dispensador de salsa  
doseur à sauce



	cm	↑ cm	ltr.	GN
93280	17,6 X 16,2	27	2,6	1/6

### Dosierpumpe, Hubvolumen 30 ml

dosing pump / riser tube, swept volume 30 ml  
bomba de salsa, sola, cada dosis 30 ml  
pompe à sauce, 30 ml par dose



	cm	↑ cm	ltr.	
93281	12,5 X 4,5	26	0,30	fits to 93280



### Dosierpumpe

dosing pump / riser tube  
bomba de salsa, sola  
pompe à sauce



**Hubvolumen 30 ml**  
swept volume 30 ml  
cada dosis 30 ml  
30 ml par dose

	∅ cm	↑ cm
88271	4,5	40



### Eier-Box

eggs box  
caja para huevos  
boîte à oeufs



**mit luftdichtem Deckel, für 4 Lagen à 30 Eier, Lieferung inkl. 8 Lagen, Größe Lage: 28 x 28 cm**  
with airtight cover, capacity: 4 trays of 30 eggs, delivery with 8 trays, size of tray: 28 x 28 cm  
capacidad para 4 bandejas de 30 huevos, tapa hermética, se entrega con 8 bandejas, formato bandejas 28 x 28 cm, apto para lavavajillas  
pour 4 plateaux de 30 oeufs chacun, apte pour 4 plateaux plats, couvercle hermétique, livré avec 8 plateaux, dimension plateau 28x28 cm, lavable en lave-vaisselle

	cm	↑ cm	GN
82419	35,4 x 32,5	20	2/3



### Aufsteller „ACHTUNG RUTSCHGEFAHR“

stand  
letrero  
panneau



	cm	↑ cm	Farbe / Colour
71421	30 x 63	63	Yellow

# Pizzaform



9 sizes



## Pizzaform

pizza dish  
molde de pizza  
moule à pizza



**Blaublech, nicht beschichtet, lange Lebensdauer, hitzebeständig bis 360 °C**  
metal sheet, without coating, long endurance, heat resistant up to 360 °C  
chapa azul, sin revestimiento, larga vida útil, resistente al calor hasta 360 °C  
métal, sans revêtement, longue durée de vie, à la chaleur jusqu'à 360 °C

	∅ cm	↑ cm
73502	16 - 18	2,5
73505	22 - 24	2,5
73506	24 - 26	2,5
73507	26 - 28	2,5
73508	28 - 30	2,5
73509	30 - 32	2,5
73510	34 - 36	2,5
73511	38 - 40	2,5
73513	48 - 50	3,0



stapelbar  
stackable



## Backhandschuhe

baking mittens  
manoplas de panadero  
gants de boulanger

**Leder, gefüttert, Einheitsgröße, mit Stulpen, extrem hitzebeständig bis 250°C**  
leather, inner lining, one size, with cuffs, extremely heat resistant up to 250°C  
cuero interior forrado, talla única, resiste a temperaturas hasta 250°C  
cuir intérieur doublé, taille unique, résiste à maxi 250°C

	→ cm
88090	45



### Gestell für Pizzaformen

rack for pizza pans  
rejilla para pizzas  
support pour moules à pizza



**Edelstahlgestell zusammenklappbar für Pizzaformen Ø 28 cm, Abstand zwischen den Ebenen 5,5 cm**

foldable stainless steel rack for pizza dishes ø 28 cm, distance between the levels 5.5 cm  
rejilla plegable de acero inoxidable para moldes de pizza de Ø 28 cm, distancia entre los niveles 5,5 cm  
support en acier inox pliable pour les moules à pizza de Ø 28 cm, distance entre les niveaux 5,5 cm

	cm	↑ cm
73515	26 x 25	26



Backofen geeignet  
suitable for oven

Pizzaform für Ø 28 cm  
pizza dish for Ø 28 cm

**Pizzaform**  
pizza dish  
molde de pizza  
moule à pizza

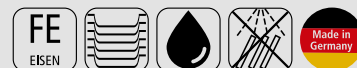

	Ø cm	↑ cm	mm
73507	26 / 28	2,5	1



### Pizzaschaufel

pizza peel  
pala de pizza  
pelle à pizza



	cm	→ cm
88080	35 x 30,5	90
88081	35 x 30,5	130



**Teig- und Pizzaballenbehälter**  
 dough and pizza ball container  
 recipiente para masa y bolas de pizza  
 récipient à pâte et boules à pizza



**Innenmaß 56,5 x 36,5 cm, H: 6,5 cm**  
 inner dimension 56,5 x 36,5 cm, H: 6,5 cm  
 medida interior 56,5 x 36,5 cm, H: 6,5 cm  
 dimension intérieure 56,5 x 36,5 cm, H: 6,5 cm

	cm	↑ cm	ltr.
82440	60 x 40	7	13



**stapelbar**  
 stackable

**passender Deckel / fitting lid / tapa adecuada / couvercle approprié**

	cm	↑ cm
82441	60 x 40	1



**Pizzaform**  
 pizza dish  
 molde de pizza  
 moule à pizza



**Blaublech, rechteckig, Rand umgelegt, hitzebeständig bis 360 °C**  
 blue steel baking sheet, rectangular, heat resistant up to 360 °C  
 chapa azul rectangular, borde plgado, resistente al calor hasta 360 °C  
 métal, rectangulaire, bord plié, à la chaleur jusqu'à 360 °C

	cm	↑ cm
88256	60 x 40	2,5



**Pizzaschneider „BLUE“**  
 pizza cutter  
 cortador de pizza  
 coupe-pizza



**ergonomischer Griff**  
 ergonomic handle  
 mango ergonómico  
 manche ergonomique

	Ø cm	→ cm
88949	10	20



**Teigschaber / Abstecher „BLUE“**  
 dough scraper  
 corta pasta  
 coupe-pâte



**starre Edelstahlklinge**  
 rigid blade stainless steel  
 hoja rígida de acero inoxidable  
 lame rigide inox

	cm
88930	15,5 x 8



**Mehlschaufel „PRO“**

scoop  
pala  
pelle à farine

**stehende Schaufel, auch für Flüssigkeiten geeignet**

standing scoop, also applicable for liquids

pala, ápto también para líquidos

adaptée pour poudres et liquides



	cm	↑ cm	ltr.	Farbe / Colour
00610	25 x 9	4,5	0,25	—
00611	31 x 12	5,5	0,5	—
00612	35 x 13	6	0,7	—

**Saucengießlöffel „CLASSIC“**

sauce / gravy ladle  
cucharón de salsa  
cuillère à sauce

**hochglanzpoliert, ergonomisch profilierter Hohl-Griff, fugenlos**

mirror polished, ergonomic designed handle, seamless

pulido brillante, asa ergonómica, sin soldadura

poli brillant, manche ergonomique, monobloc (sans soudure)



	cm	Griff / handle cm	ltr.
75906	7 x 5,5	22	0,02

**Pinsel**

brush  
brocha  
pinceau pâtissier

**weißgebleichte, naphtalinfreie Borsten, temperaturbeständig von -40°C bis +95°C**

bleached bristles, heat-resistant from -40°C to +95°C

cerdas blanqueadas, resistencia térmica -40°C hasta +95°C

soies blanchies sans naphtaline, résistance de - 40°C à + 95°C



	cm	→ cm
77350	4 x 1	23,5

**Schüssel**

bowl  
ensaladera  
saladier  
glasklar

crystal clear

cristalina

transparent



	Ø cm	↑ cm	ltr.	Farbe / Colour
30260	32,5	10	4	—
30263	40	12	8	—

**Korkuntersetzer**

cork mat  
salvamanteles  
dessous-de-plat liège

**ideal für Servier- und Eisenpfannen**

ideal for iron pan

ideal para servir en sartenes de chapa

idéal pour présenter les poêles forgées sur table



	Ø cm	↑ cm
73750	24	2





# Hauben & Zubehör

covers & accessories  
campanas & accesorios  
cloches & accessoires

GN COVERS.....	484
GN ROLLTOP COVERS.....	487
ROLLTOP COVERS.....	488
SUPER DOME.....	489
PLATE COVERS.....	490
COVERS.....	491
LIDS.....	493
COOLERS.....	496
TO GO CUP.....	497

# QUALITÄTSHAUBEN

11042  
GN 1/1

11041  
GN 1/2



11043 GN 1/3



11044 GN 2/4



11041 GN 1/2



11042 GN 1/1

## GN Abdeckhaube

GN cover  
GN cubierta  
GN cloche



passend für GN Tablett, glasklarer Kunststoff, nahezu bruchfest

suitable for GN trays, clear plastic, nearly unbreakable

apto para bandejas GN, plástico transparente, muy resistente a la rotura

pour bacs et plateaux GN, plastique transparent, très résistant à la casse

	cm	↑ cm	* mm	GN
11043	32,5 x 17,6	10,5	3	1/3
11044	53,0 x 16,2	10,5	3	2/4

	cm	↑ cm	* mm	GN
11041	32,5 x 26,5	9,5	3	1/2
11042	53,0 x 32,5	9,5	3	1/1



stapelbar  
stackable



## GN 1/1 Haube „HOCHSTAPLER“

GN 1/1 cover  
GN 1/1 campana  
GN 1/1 cloche



glasklarer Kunststoff, Tablett fixiert sich auf der Haube - kein Rutschen möglich, nahezu bruchfest

clear plastic, tray fixes itself on the cover and can not slip off, nearly unbreakable

plástico transparente, la bandeja se fija a la tapa para que no se deslice, muy resistente a la rotura

en plastique transparent, le plat se fixe sur le dessous de la cloche pour ne pas glisser, très résistant à la casse

	cm	↑ cm	GN	fits to
11305	53 x 32,5	9	1/1	11295, 11300



## GN Kuppelhaube

GN cover  
GN cúpula  
GN cloche bombée

glasklarer Kunststoff, Griff aus Zinkdruckguss

crystal clear plastic, die-cast zinc knob

plástico transparente, asa de zinc fundido a presión

plastique transparente, poignée en zinc moulé sous pression

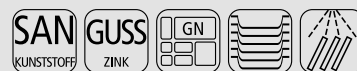

	cm	↑ cm	GN	
11021	33 x 28	17	1/2	geschlossen / totally closed cerrada / toalemt fermée
11022	33 x 28	17	1/2	mit Front-Ausschnitt / one long side cut out gran apertura frontal grande ouverture frontale
11026	54 x 33	20	1/1	geschlossen / totally closed cerrada / toalemt fermée
11027	54 x 33	20	1/1	mit Front-Ausschnitt / one long side cut out gran apertura frontal grande ouverture frontale
11028	54 x 33	20	1/1	mit seitlichem Ausschnitt one small side cut out pequeña apertura lateral petite ouverture latérale





**GN Kuppelhaube**

GN cover  
GN cúpula  
GN cloche bombée



glasklarer Kunststoff, Griff aus Zinkdruckguss

crystal clear plastic, die-cast zinc knob

plástico transparente, asa de zinc fundido a presión

plastique transparente, poignée en zinc moulé sous pression

	cm	↑ cm	GN	
11070	54 x 33	20	1/1	geschlossen / totally closed cerrada / totalmente fermée
11071	54 x 33	20	1/1	mit Front-Ausschnitt / one long side cut out gran apertura frontal grande ouverture frontale
11072	54 x 33	20	1/1	mit seitlichem Ausschnitt one small side cut out pequeña apertura lateral petite ouverture latérale
11073	33 x 28	17	1/2	geschlossen / totally closed cerrada / totalmente fermée
11074	33 x 28	17	1/2	mit Front-Ausschnitt / one long side cut out gran apertura frontal grande ouverture frontale



**GN 1/1 Haube**

GN 1/1 cover  
GN 1/1 campana  
GN 1/1 cloche



klappbar, passend für GN 1/1-Behälter, GN 1/1-Tabletts, etc., nahezu bruchfest

suitable for GN 1/1 chafing dish, GN 1/1 trays, GN 1/1 pans

plegable, para cubetas GN 1/1, bandejas GN 1/1 etc., muy resistente a la rotura

pliable, pour bacs GN 1/1, plateaux GN 1/1 etc., très résistant à la casse

	cm	↑ cm	GN
11013	53,0 x 32,5	6	1/1



klappbar  
adjustable



**GN 1/1 Rolltophaube**

GN 1/1 rolltop cover  
GN 1/1 campana rolltop  
GN 1/1 cloche rolltop



patentiert, passend für GN-Behälter, -Tablets, etc., leichtgängig auf- und zuklappbar 90°  
patented, suitable for GN trays, solid quality, 90° opening  
patentada, para cubetas GN, bandejas GN, etc. fácil de abrir y cerrar 90°  
brevetée, pour bacs GN, plateaux GN, etc. s'ouvre et se ferme facilement à 90°

	cm	↑ cm	GN
11075	53,0 x 32,5	19	1/1



**GN Rolltophaube**

GN rolltop cover  
GN campana rolltop  
GN cloche rolltop



patentiert, passend für GN-Behälter, -Tablets, etc., leichtgängig auf- und zuklappbar 90°  
patented, suitable for GN trays, solid quality, 90° opening  
patentada, para bandejas GN, apertura 90°  
brevetée, pour plateaux GN, ouverture 90°

	cm	↑ cm	GN	
11008	53,0 x 32,5	19	1/1	vergoldeter Griff / gold plated handle pomo dorado / bouton doré
11010	53,0 x 32,5	19	1/1	verchromter Griff / chrome plated handle pomo cromado / bouton chromé
12008	32,5 x 26,5	15	1/2	vergoldeter Griff / gold plated handle pomo dorado / bouton doré
12010	32,5 x 26,5	15	1/2	verchromter Griff / chrome plated handle pomo cromado / bouton chromé



**GN 1/1 Rolltophaube „SUNDAY“**

GN 1/1 rolltop cover  
GN 1/1 campana rolltop  
GN 1/1 cloche rolltop



Griff ABS verchromt, leichtgängig auf- und zuklappbar  
handle chrome plated, easy to open and close  
asa material ABS cromado, fácil de abrir y cerrar  
poignée matériel ABS chrome, ouverture et fermeture faciles

	cm	↑ cm	GN
11016	53,0 x 32,5	19	1/1



**GN 1/1 Rolltophaube**

GN 1/1 rolltop cover  
GN 1/1 campana abatible  
GN 1/1 cloche basculante



verchromter Zinkdruckguss-Griff / chrome plated metal handle / mango cromado de fundición a presión de zinc / poignée en zinc moulé sous pression chromé

	cm	↑ cm	GN
11018	53,0 x 32,5	19	1/1



**Rolltophaube „FOCUS“**

rolltop cover  
campana abatible  
cloche basculante



verchromter Griff / chrome plated handle / pomo cromado / bouton chromé

	cm	↑ cm
09013	44 x 33,5	17

## ROLLTOP COVERS



### Rolltophaube

rolltop cover  
campana abatible  
cloche basculante

glasklarer Kunststoff, leichtgängig auf- und zuklappen 90°

solid quality, to be opened 90°

plástico transparente, apertura 90°

plastique transparent résistant, ouverture 90°



	Ø cm	↑ cm	
18388	38	20	mit verchromtem Kugelgriff / with chrome plated handle con pomo cromado / avec bouton chromé
18387	38	20	mit vergoldetem Kugelgriff / gold plated handle pomo dorado / bouton doré
09023	38	20	mit verchromtem Zylindergriff / chrome plated handle pomo cromado / bouton chromé
18380	50	26	mit verchromtem Zylindergriff / chrome plated handle pomo cromado / bouton chromé



### Frischhaltehaube

cover  
campana  
cloche

schwere, glasklare Qualität

stable, crystal clear quality

calidad estable y transparencia cristalina

qualité stable et clarté cristalline



	Ø cm	↑ cm	fits to
06519	21	17	33292, 33293
06520	30	22	00046, 00463, 00468, 00469, 00818, 00975, 00998, 15621, 15622, 33294, 33295, 83884, 83890, 83891, 84177, 84943, 84944
06521	36	27	00816, 33296, 33297



stapelbar  
stackable



Präsentationsmöglichkeiten  
presentation examples





# SUPER DOME



06525 Ø 30 cm



85052

## Frischhaltehaube „SUPER DOME“

cover  
campana  
cloche

schwere, glasklare Qualität  
stable, crystal clear quality  
muy resistente y transparencia cristalina  
haute résistance et transparence



	Ø cm	↑ cm
06525	30	40

passende Servier- Tortenplatten / suitable cake stands / porta pasteles compatibles /  
présentoirs à gâteaux compatibles

	Ø cm	↑ cm	fits to	Farbe / Colour
00468	31,0	3,5	06525	
33294	33,0	8,0	06525	
33295	33,0	16,0	06525	



85112

Servierbeispiel  
presentation example



06525

Präsentationsmöglichkeiten  
presentation examples



06525

85051

85052

00468

## PLATE COVERS



### Tellerabdeckhaube

plate cover  
cubierta para plato  
couvertcle pour assiette



passend für unterschiedliche Tellergrößen

suitable for different plate sizes  
aptas para diferentes tamaños de platos  
aptes pour différentes tailles d'assiettes

	Ø cm	↑ cm	passend für Tellergrößen / suitable for plate sizes
11051	22,0	7,0	Ø 21,5 cm
11052	24,0	7,5	Ø 22,5 - 23,0 cm
11053	28,0	6,5	Ø 26,0 - 26,5 cm
11054	28,5	6,5	Ø 27,0 - 27,5 cm



Servierbeispiele  
presentation example



passende Hauben  
suitable covers 11051, 11052



### Frischhaltehaube

cover  
campana  
cloche bombée



glasklar, Griff verchromt, schwere, stabile Ausführung

transparent, chrome knob, heavy stable quality  
transparente, asa cromada, alta estabilidad  
transparente, anse chromée, très stable

	Ø cm	↑ cm	fits to
15350	16,5	10	15130
15351	20,5	10	15131, 15141, 15271





06512

**Frischhaltehaube**cover  
campana  
cloche**glasklar, schwere stabile Ausführung, stapelbar**clear, heavy stable quality, stackable  
transparente, alta estabilidad, apilable  
transparente, très stable, empilable

	Ø cm	↑ cm	
06512	30	11,5	mit verchromtem Griff / with chrom plated handle con botón cromado / avec bouton chromé
06517	30	11,5	mit verchromtem Griff / with chrom plated handle con botón cromado / avec bouton chromé



06515

**Frischhaltehaube**cover  
campana  
cloche**glasklar, schwere stabile Ausführung, stapelbar**clear, heavy stable quality, stackable  
transparente, alta estabilidad, apilable  
transparente, très stable, empilable

	Ø cm	↑ cm	
06510	30	11,5	
06515	33	12,5	

**stapelbar**  
stackable

06501

**Frischhaltehaube**cover  
campana  
cloche

	Ø cm	↑ cm	
06501	30	11	
06504	30	9,5	
06506	30	7	

**Frischhaltehauben, 2er Set**covers, 2 pcs. set  
campanas, set de 2  
cloches, pack de 2

	Ø cm	↑ cm	
40752	30	11	

# COVERS



## Frischhaltehaube

cover  
campana  
cloche



	Ø cm	↑ cm	fits to
11055	23	12	00825, 00827, 00848, 30148, 30334



Set 00827

glasklar, schwere stabile Ausführung  
clear, heavy stable quality



## Frischhaltehaube

cover  
campana  
cloche



	cm	↑ cm	fits to
11056	25 x 12	10	00826, 00828, 00849, 30149, 30338, 85099



Set 00828

glasklar, schwere stabile Ausführung  
clear, heavy stable quality



06401

06701

## Frischhaltehaube

cover  
campana  
cloche



	cm	↑ cm
06401	29,5 x 13,5	10
06701	21,6 x 16,2	7



18621

Lieferung ohne Tablett | delivery without tray

18121

## Frischhaltehaube

cover  
campana  
cloche



	cm	↑ cm
18621	Ø 18	8,5
18121	35,5 x 27,8	7,5

# FRIDA



... zu jeder Schale der  
**PASSENDE  
DECKEL**



84962 Ø 9 cm



84963 Ø 13 cm



84964 Ø 16 cm

## Deckel „FRIDA“

cover  
tapa  
couvercle



	Ø cm	↑ cm	fits to	€
84962	9	2,5	84930, 84931	
84963	13	2,5	84605, 84606	
84964	16	2,5	84607, 84608	



84931



84607



84608



84962  
84931  
84962  
84930



84963  
84606



stapelbar / stackable



84965 13 x 13 cm



84966 17 x 17 cm



84967 18 x 16,5 cm



84968 18 x 11 cm

## Deckel „FRIDA“

cover  
tapa  
couvercle



	cm	↑ cm	fits to	€
84965	13 x 13,0	2,5	84936, 84937	
84966	17 x 17,0	2,5	84558, 84559	
84967	18 x 16,5	2,5	84583, 84584	
84968	18 x 11,0	2,5	84555, 84556	



84937



84559



84558



84968  
84556  
84968  
84555



84967  
84584



stapelbar / stackable

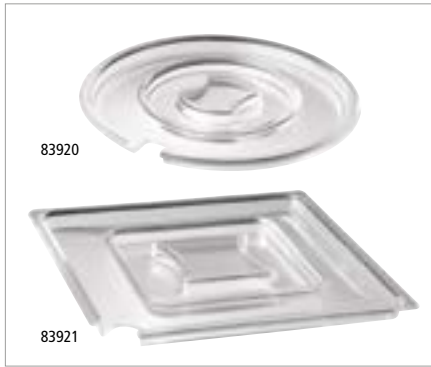

**Deckel „FLOAT“ mit Löffelaussparung**

cover, with notched for spoons  
tapa, con espacio para la cuchara  
couvrele, avec encoche pour la louche



	cm	↑ cm	fits to	
83920	Ø 20,5	1,3	00794, 83704, 83705, 83908, 83909, 85250	rund
83921	19 x 19	1,3	83916, 83917	eckig
83922	25 x 25	1,3	83918, 83919	eckig



**Deckel „PURE“ mit Löffelaussparung**

cover with notched for spoons  
tapa con espacio para la cuchara  
couvrele avec encoche pour la louche



	cm	↑ cm	fits to	
83600	19 x 19	1,5	79004, 79005, 83409, 83468, 84244, 85260, 85266	
83601	25 x 25	1,5	83469, 83408, 84245, 84561, 84562, 85261, 85267	



**Deckel „PURE“, 5er Set**

cover, 5 pcs.  
tapa, set de 5  
couvrele, set de 5



**Hygienischer Schutz für Ihre Speisen**  
• dichtschießend  
• schwappsicherer Transport  
protection for your food  
• tightly closing  
• slosh-proof transport

protección de alimentos  
• con cierre hermético  
• transporte sin salpicaduras  
protection des aliments  
• fermeture hermétique  
• transport sans éclaboussures

	Ø cm	↑ cm	fits to	pcs.
83603	13,0 x 13,0	0,5	79002, 79003, 83410, 83467	5
83604	19,5 x 19,5	0,5	79004, 79005, 83409, 83468, 84244, 84830, 85260, 85266	5



**Deckel „CASUAL“, 5er Set**

cover, 5 pcs. set  
tapa, set de 5  
couvrele, set de 5



**Hygienischer Schutz für Ihre Speisen**  
• dichtschießend  
• schwappsicherer Transport  
protection for your food  
• tightly closing  
• slosh-proof transport

protección de alimentos  
• con cierre hermético  
• transporte sin salpicaduras  
protection des aliments  
• fermeture hermétique  
• transport sans éclaboussures

	Ø cm	↑ cm	fits to	pcs.
83605	8,0	0,5	11866, 15400, 15416, 15461, 15462, 15467, 40655, 40656, 83881	5
83606	14,5	0,5	11865, 83700, 83701, 85104, 85105, 85107	5
83607	20,5	0,5	15404, 15420, 83704, 83705	5

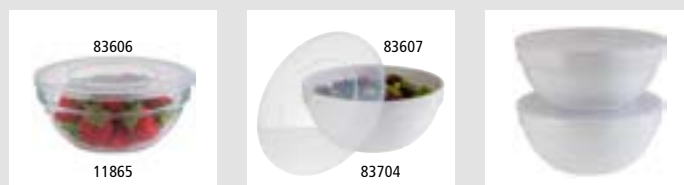

stapelbar  
stackable



10890

### Frischhaltedeckel

airtight cover  
tapa hermética  
couvercle hermétique



mit Silikondichtung, für luftdichtes Verschließen, Lebensmittel bleiben lange frisch

with silicone sealing ring, bowls closed airtight, to keep food fresh for a long time  
junta de silicona para cerrar herméticamente y mantener los alimentos frescos más tiempo  
joint de silicone pour fermeture hermétique et meilleure conservation des aliments

	Ø cm	fits to
10890	14	11865, 83700, 83701
10887	23	11846, 11848, 11875, 83702, 83703



zwei Öffnungspositionen des Deckels  
two opening positions of the lid



11868

11878

### Schutzdeckel mit Löffelaussparung

cover  
tapa  
couvercle



glasklar, klappbar, mit 10 Beschriftungsschildern

transparent, with 10 cards for inscription  
plástico transparente, con 10 etiquetas para inscripción  
plastique transparent, avec 10 étiquettes pour inscription

	Ø cm	
11868	14,5	mit verchromtem Griff / chrome plated handle botón cromado / bouton chromé
11878	23,5	mit verchromtem Griff / chrome plated handle botón cromado / bouton chromé

Schilder, 10er Set / signs, 10 pcs. set / set de 10 cartelitos / set de 10 étiquettes

	fits to
12879	11868
11879	11878



### Deckel klappbar mit Löffelaussparung

cover hinged  
tapa con bisagra  
couvercle avec charnière



glasklar, mit Designer-Griff, verchromt, ohne Beschriftungsschild

clear, with designer handle, chrome plated, without card for inscription  
transparente, con pomo de diseño cromado, sin tarjetas para inscripción  
transparent, avec bouton chromé de design, sans étiquette pour inscription

	Ø cm	fits to
10889	23,5	11817, 11818, 11845, 11847, 11849



11875

### Schale

bowl  
cuenco  
bol



	Ø cm	↑ cm	litr.	VE / unit
11859	6,0	2,5	0,05	36
11866	7,5	3,5	0,09	36
11865	14,0	6,5	0,50	6
11875	23,0	10,5	2,50	6

## COOLERS



### Kühlakku

cooler  
acumulador de frío  
accumulateur de froid



gefüllt mit Kühlflüssigkeit, nicht giftig, einfach im Gefrierfach einfrieren, unbegrenzt wiederverwendbar

freeze it in freezer, non toxic, filled with freezer-liquid, boundless reusable  
se enfría en el congelador, no tóxico, se puede reutilizar sin límite  
liquide eutectique qui accumule froid une fois dans le congélateur, non toxique, réutilisable sans limites

	Ø cm	↑ cm	Farbe / Colour
10777	15	2,5	White
10781	10,5	2,5	White
10661	10,5	2,0	White



### Kühlakku

cooler  
acumulador de frío  
accumulateur de froid



	Ø cm	→ cm	Farbe / Colour
00615	7,5	11,5	Black



### Kühlakku

cooler  
acumulador de frío  
accumulateur de froid



gefüllt mit Kühlflüssigkeit, nicht giftig, einfach im Gefrierfach einfrieren, unbegrenzt wiederverwendbar

freeze it in freezer, non toxic, filled with freezer-liquid, boundless reusable  
se enfría en el congelador, no tóxico, se puede reutilizar sin límite  
liquide eutectique qui accumule froid une fois dans le congélateur, non toxique, réutilisable sans limites

	cm	↑ cm	Farbe / Colour	
10782	41 x 21	2,5	White	
10791	25 x 19	2,5	White	
11101	16 x 7,5	2,0	Blue	4er Set / 4 pieces set / set de 4 / set de 4



### Aufsteller „ACHTUNG RUTSCHGEFAHR“

stand  
letrero  
panneau



	cm	↑ cm	Farbe / Colour
71421	30 x 63	63	Yellow



NEW

# Der nachhaltige Mehrwegbecher – made in Germany



eco-friendly

400 ml



Das Rippendesign isoliert die Hitze – kein „Verbrennen“ der Finger möglich

The rib design insulates the heat - no „burning“ of the fingers possible

Mehrwegbecher individuell mit Ihrem Logo/Namen herstellbar ab 500 Stck. – sprechen Sie uns an!

Reusable cups can be individually produced with your logo/name. From 500 pieces - please contact us!

- ✓ aufsteckbarer Deckel mit Trinköffnung
- ✓ 100% recyclebar
- ✓ spülmaschinengeeignet
- ✓ stapelbar mit und ohne Deckel
- ✓ schwappsicher

- clip-on lid with drinking opening
- 100% recyclable
- dishwasher safe
- stackable with and without lid
- slosh-/leak-proof



NEW

## To Go Mehrwegbecher

To Go reusable cup  
vaso reutilizable To Go  
tasse réutilisable To Go  
**Becher (ohne Deckel)**  
cup (without cover)  
vaso (sin tapa)  
tasse (sans couvercle)



	Ø cm	↑ cm	ltr.	Farbe / Colour	VE / unit
66910	8,5	13,5	0,4		48
66911	8,5	13,5	0,4		48
66912	8,5	13,5	0,4		48
66913	8,5	13,5	0,4		48

### Deckel / cover / tapa / couvercle

	Ø cm	↑ cm	Farbe / Colour	VE / unit
66914	8,5	2,5		48
66915	8,5	2,5		48
66916	8,5	2,5		48
66917	8,5	2,5		48

*Laser-Logo  
Individual*

# Laserlogo Individual

- perfekte Lasergravuren
- perfectly Laser engravings
- grabado perfecto por láser
- marcage laser parfait



**DE**

- unverwechselbar
- einzigartig
- imagefördernd

## Ihre individuelle Lasergravur von APS

Wir bieten Ihnen die Möglichkeit, unsere Produkte mit Ihrem individuellen Logo per Laser zu gravieren - einzigartig, unverwechselbar und bereits ab 10 Stück je Artikel. Die perfekte Beschriftung durch modernste Lasertechnologie ist spülmaschinenfest und somit dauerhaft auf allen Edelstahl- und Naturschieferprodukten, sowie auf versilberten und verchromten Metall-Artikeln umsetzbar. Machen Sie aus Ihren Gastronorm-Behältern Ihre ganz persönlichen Unikate und werten Sie Ihre Servierartikel mit Ihrem eigenen Logo auf.

- geringe Mindestbestellmenge von nur 10 Stück
- kurze Lieferzeiten
- Logos bis zu einer Fläche von max. 10 x 10 cm realisierbar

**ES**

- único
- personalizado
- promotor de imagen

## Grabado laser por APS

Podemos grabar su logo y así personalizar los productos APS a partir de mínimo 10 unidades por referencia. Gracias a la novedosa tecnología de grabado por láser, la inscripción es perfecta y resistente al lavavajillas. Se puede aplicar a los artículos en acero inoxidable, pizarra natural, metal cromado y plateado.

- cantidad mínima de solamente 10 unidades
- realización rápida
- tamaño de logos hasta máximo 10 x 10 cm

**EN**

- distinct
- unique
- image enhancing

## Your individualised laser engraving by APS

We offer you the option of having your personalised logo engraved on our products - inimitable, unique, and available for delivery from only 10 pieces per product. The perfect inscription by use of the newest technology is dishwasher-safe and thus can be permanently applied to products made of stainless steel and natural slate, as well as silver-coated and chromed metal articles. Turn your gastronorm container into your individual, one of a kind article and enhance your serving items with your own logo.

- minimum order quantity of only 10 pieces
- swift delivery
- feasible logos are those with a maximum size of 10 x 10 cm

**FR**

- unique
- original
- porteur d'image

## Marcage laser par APS

Nous pouvons graver votre logo et ainsi personnaliser les produits APS à partir de 10 pièces par référence. Grâce à une technologie d'avant-garde de marquage par laser, l'inscription est parfaitement reproduite et résistante au lave-vaisselle. Ce type de marquage peut s'appliquer sur l'acier inoxydable, sur l'ardoise naturelle, sur le métal chromé ou argenté.

- quantité minimum de seulement 10 unités
- fabrication rapide
- taille du logo jusque 10 x 10 cm



## APS - BSCI-Mitglied

APS engagiert sich für die Verbesserung von Arbeitsbedingungen.

Wir sind Partner der europäischen Organisation BSCI. Die "Business Social Compliance Initiative" (BSCI) ist eine Initiative von Unternehmen zur Verbesserung der Arbeitsbedingungen in der globalen Versorgungskette.



## APS is a member of BSCI

APS is committed to the improvement of working conditions.

We are a partner of the European organization BSCI. The "Business Social Compliance Initiative" is an initiative of enterprises to improve working conditions in the global supply chain.

## APS Melamin - Garantierte Qualität

APS-Melaminprodukte entsprechen den Richtlinien (EG) 1935/2004 und (EU) 10/2011 der Europäischen Kommission. Diese enthalten Bestimmungen für Materialien aus Kunststoffen, welche mit Lebensmitteln in Berührung kommen. Wir arbeiten sehr eng mit Zertifizierungsinstitutionen und Prüflaboren zusammen und können somit die Lebensmittelsicherheit (LFGB Regulation) der APS-Melaminartikel garantieren.

## APS Melamine - Guaranteed quality

APS melamine products comply with directives (EG) 1935/2004 and (EU) 10/2011 of the European Commission. This contain provisions for plastic materials which come into contact with foodstuffs. We work very closely together with certification institutions and testing laboratories and are therefore able to guarantee the compatibility with foodstuffs (German LFGB regulation) of APS melamine.

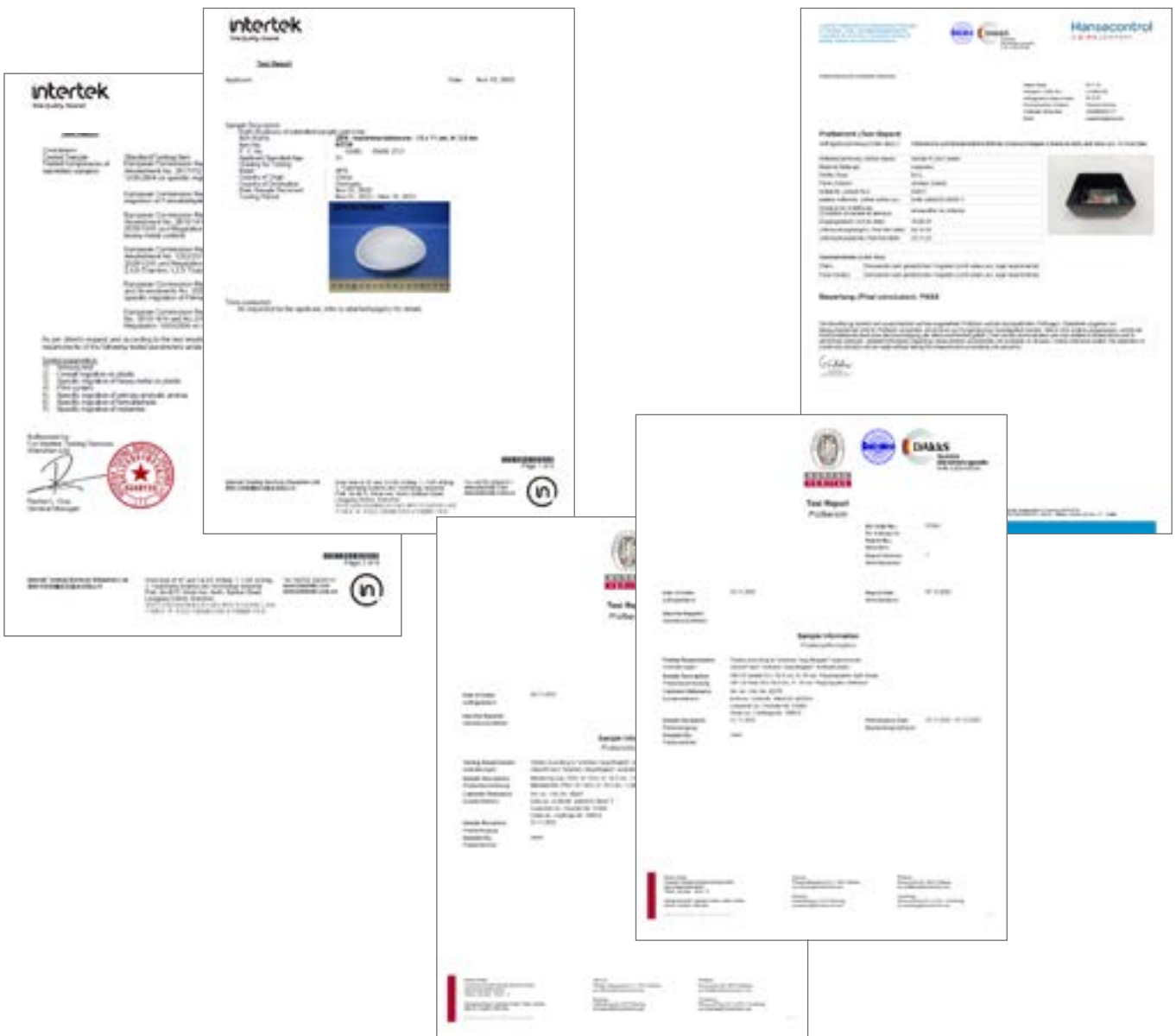

## Icon-Index

 <b>neuer Artikel</b> new item	 <b>spülmaschinengeeignet</b> dishwasher-proof	 <b>für Induktionsplatten</b> for induction use	 <b>max. 70°C</b>
 <b>GN-Größen</b> GN norm	 <b>nicht spülmaschinen-geeignet</b> not dishwasher-proof	 <b>feucht abwaschbar</b> wet washable	 <b>kühlbar</b> for cooling
 <b>Made in Germany</b>	 <b>Made in the EU</b>	 <b>bruchsicher</b> shatter-proof	 <b>nicht für Lebensmittelkontakt</b> not food safe
 <b>mikrowellengeeignet</b> microwave-proof	 <b>Antirutsch-Füßchen</b> non-slip feet	 <b>stapelbar</b> stackable	 <b>Eigenmontage</b> self assembly
 <b>nicht mikrowellen-geeignet</b> not microwave-proof	 <b>nicht für Backofen</b> not for baking oven	 <b>keine direkte Hitze</b> not direct heat	

## Material-Index



### Aluminium

sehr leichtes Material; sehr gute elektrische und thermische Leitfähigkeit; korrosionsbeständig; Gebrauchstemperatur bis ca. +500 °C

Pflege:

niemals scheuernde Hilfsmittel verwenden; nur mit weichem Lappen und Spezialmitteln reinigen; keine Spülmaschinenreinigung!

### Aluminium

Very light material; very good electrical and thermal conductivity; corrosion-resistant; service temperature up to approx. +500 °C

Care:

never use abrasive cleaners; clean only with a soft cloth and special cleaning agents; not suitable for dishwashers



### Edelstahl 18/10

Werkstoff 1.4301; rostfrei; langlebig; gute isolierende Eigenschaften; absolut hygienisch und nicht toxisch; recyclebar; nicht resistent gegen dauerhaften Kontakt mit Chloriden und Säuren (z. B. Kochsalz und Fruchtsäuren); sterilisierbar; Oberfläche lässt sich vielfältig polieren; nicht magnetisch; Gebrauchstemperatur bis ca. 400 °C

Pflege

pflegeleicht; maschinell oder per Hand mit milden Spülmitteln; möglichst keine Stahlwolle u. ä. verwenden; nach Erhitzung Schockabkühlung vermeiden

### Stainless steel 18/10

Material 1.4301; stainless; durable; good insulating properties; absolutely hygienic and non-toxic; recyclable; not resistant to permanent contact with chlorides and acids (e.g. table salt and fruit acids); sterilisable; surface can be polished in many ways; non-magnetic; service temperature up to approx. 400 °C

Care

easy to clean; machine or hand wash with mild detergents; if possible, do not use steel wool or similar; Avoid shock cooling after heating.



### Edelstahl (unspezifisch)

niedrig nickelhaltige Edelstähle wie 14/4; nicht magnetisch; geringere allgemeine Resistenz als Edelstahl 18/10;

Pflege:

pflegeleicht; maschinell oder per Hand mit milden Spülmitteln; möglichst keine Stahlwolle u. ä. verwenden; nach Erhitzung Schockabkühlung vermeiden

### Stainless steel (unspecific)

Stainless steel with low nickel content such as 14/4; non-magnetic; lower general resistance than 18/10 stainless steel

Care:

easy to clean; machine or hand wash with mild detergents; if possible, do not use steel wool or similar; Avoid shock cooling after heating.



### Edelstahl 18/0

Werkstoff 1.4016; rostfrei; langlebig bei entsprechender Pflege; absolut hygienisch und nicht toxisch; gut härtbar, daher idealer Stahl für Tafelmesser, Tablets, Schneidwerkzeuge u. ä.; lässt sich hochglanzpolieren; für Nickel-allergiker geeignet; magnetisch; nicht so chemikalienresistent wie Edelstahl 18/10; Gebrauchstemperatur bis ca. 400 °C

Pflege:

maschinell oder per Hand mit milden Spülmitteln; Ablagerungen von Kalk und Reinigerresten nach dem Spülen unbedingt entfernen; niemals mit Stahlwolle reinigen

### Stainless steel 18/0

Material 1.4016; stainless; long-lasting with appropriate care; absolutely hygienic and non-toxic; good hardening properties, therefore ideal steel for table knives, trays, cutting tools, etc.; can be polished to a high gloss; suitable for people allergic to nickel; magnetic; not as resistant to chemicals as stainless steel 18/10; service temperature up to approx. 400 °C

Care:

by machine or by hand with mild detergents; Remove limescale and detergent residues after cleaning; never clean with steel wool



### Eisen

nicht rostfrei; charakteristische, strukturierte Oberfläche mit unterschiedlichen Schattierungen; durch wiederholten Schmiedevorgang ist das Material stark verdichtet und sehr hart; langlebig bei entsprechender Pflege

Pflege:

vor erstem Einsatz mit Öl und Kartoffelschalen „einbraten“; später nach jeder Reinigung einfetten; stets trocken lagern

### Iron

not rustproof; characteristic, structured surface with different shades; due to repeated forging process, the material is strongly compressed and very hard; long-lasting with appropriate care,

Care:

before first use, fry with oil and potato peelings; later grease after each cleaning; always store in a dry place.



### Gusseisen

langlebig bei entsprechender Pflege; geeignet für alle Herdarten (inkl. Induktion); speichert lange Wärme und gibt sie gleichmäßig ab; absolut hygienisch bei unbeschädigter Oberfläche; relativ schweres Material; Überhitzung fast nicht möglich; nicht schlagfest; magnetisch

Pflege:

nach Gebrauch sofort mit heißem Wasser reinigen; bei Fleckenbildung mit Essig nachreinigen; niemals mit Stahlwolle reinigen; milde Spülmittel verwenden; stets trocken lagern

### Cast Iron

Long-lasting with appropriate care; suitable for all types of cookers (incl. induction); stores heat for a long time and releases it evenly; absolutely hygienic with undamaged surface; relatively heavy material; overheating is almost impossible; not impact-resistant; magnetic

Care:

clean immediately with hot water after use; clean with vinegar if stains form; never clean with steel wool; use mild detergents; always store in a dry place



### Verchromter Stahl

nichtedles Metall mit hartem Chromüberzug; nicht säurefest; nach Beschädigung der Chromschicht kein Schutz gegen Umwelteinflüsse

Pflege:

niemals scheuernde Hilfsmittel verwenden; nur mit weichem Lappen

### Chrome plated steel

Metal with hard chrome coating; not acid-resistant; after damage to the chrome layer no protection against environmental influences

Care:

never use abrasive cleaners; only with a soft cloth



### Versilberter Stahl

Edelmetallüberzug; nicht völlig säurefest; nicht über längere Zeit Sonnenlicht aussetzen

Pflege:

niemals scheuernde Hilfsmittel verwenden; nur mit weichem Lappen und Spezialmitteln reinigen; keine Spülmaschinenreinigung!

### Silver plated steel

Metal coating; not completely acid-resistant; do not expose to sunlight for long periods of time

Care:

never use abrasive cleaners; clean only with a soft cloth and special cleaning agents; not suitable for dishwashers



### ABS – Acrylnitril-Butadien-Styrol

sehr gute Oberflächenhärte; temperaturwechselfest; Gebrauchstemperatur bis ca. +100 °C

Pflege:

spülmaschinengeeignet

### ABS - acrylonitrile butadiene styrene

very good surface hardness; resistant to temperature changes; service temperature up to approx. +100 °C

care:

dishwasher safe



### ACRYL – künstliches Harz

farblos; glasartig; durchsichtig; nicht splinternd; chemisch modifiziert als Plexiglas®; Gebrauchstemperatur ca. -40 °C bis ca. +50 °C

wichtiger Pflegehinweis:

nur handelsübliche Acrylspezialreiniger oder milde alkohol- und ammoniakfreie Reinigungsmittel verwenden; nicht spülmaschinengeeignet;

### ACRYL - artificial resin

colourless; glass-like; transparent; not splintering; chemically modified as Plexiglas®; service temperature approx. -40 °C to approx. +50 °C

important care advice:

use only commercially available acrylic special cleaners or mild and ammonia-free cleaning agents; not suitable for dishwashers



### EVA - Ethylenvinylacetat

weich elastisch; glänzend; Gebrauchstemperatur bis ca. +60 °C

Pflege:

abwaschbar / wasserfest

### EVA - ethylene vinyl acetate

soft elastic; glossy; service temperature up to approx. +60 °C

care:

washable / waterproof



### GFK – Glasfaserverstärkter Kunststoff

starr; nahezu unzerbrechlich; Gebrauchstemperatur bis ca. +100 °C

Pflege:

spülmaschinengeeignet

### GFK - glass-fibre reinforced plastic

rigid; almost unbreakable; service temperature up to approx. +100 °C

care:

dishwasher-safe



### MF - Melamin

sehr hart; stoß- und kratzfest; hygienisch; Gebrauchstemp. ca. -30 °C bis +70 °C

Pflege:

säurebeständig; spülmaschinengeeignet

### MF - melamine

very hard; impact- and scratch-resistant; hygienic; service temp. approx. -30 °C to +70 °C

care:

acid-resistant; dishwasher safe



### MS - Kunststoff

farblos; glasartig; durchsichtig; Gebrauchstemperatur ca. 0 °C bis ca. +70 °C

Pflege:

nicht spülmaschinengeeignet

### MS - plastic

colourless; glass-like; transparent; service temperature approx. 0 °C to +70 °C

care:

not dishwasher-safe



### PA - Polyamid

starr; bruch- und schlagfest; mattglänzend; Gebrauchstemperatur bis ca. +220 °C

Pflege:

spülmaschinengeeignet

### PA - polyamide

rigid; break- and impact-resistant; matt glossy; service temperature up to approx. +220 °C

care:

dishwasher-safe

**PC - Polycarbonat**

starr; nahezu unzerbrechlich; sehr stabil; formbeständig in kochendem Wasser; mikrowelleneeignet; Gebrauchstemperatur ca. -30 °C bis ca. +100 °C  
 Pflege:  
 spülmaschineneeignet

**PC - polycarbonate**

rigid; almost unbreakable; very stable; keeps its shape in boiling water; microwave safe; service temperature approx. -30 °C to approx. +100 °C  
 care:  
 dishwasher-safe

**PE - Polyethylen / HDPE – hochdichtes Polyethylen**

hart elastisch; unzerbrechlich; ausreichend formbeständig in heißem Wasser; glänzend; Gebrauchstemperatur ca. -30 °C bis ca. +120 °C  
 Pflege:  
 spülmaschineneeignet

**PE - polyethylene / HDPE - high-density polyethylene**

hard elastic; unbreakable; sufficiently dimensionally stable in hot water; shiny; service temperature approx. -30 °C to approx. +120 °C  
 care:  
 dishwasher safe

**NDPE – niederdichtes Polyethylen**

weich elastisch; unzerbrechlich; kurzzeitig formbeständig in heißem Wasser; nicht glänzend; Gebrauchstemperatur ca. -30 °C bis ca. +95 °C  
 Pflege:  
 spülmaschineneeignet

**NDPE - low density polyethylene**

soft elastic; unbreakable; briefly keeps its shape in hot water; not shiny; service temperature approx. -30 °C to approx. +95 °C  
 care:  
 dishwasher safe

**PET - Polyethylenterephthalat**

hart elastisch; ausreichend formbeständig in heißem Wasser; glänzend; Gebrauchstemperatur ca. -30 °C bis ca. +55 °C  
 Pflege:  
 spülmaschineneeignet bis 55°C

**PET - Polyethylene terephthalate**

hard elastic; sufficiently dimensionally stable in hot water; shiny; service temperature approx. -30 °C to approx. +55 °C  
 care:  
 dishwasher safe up to 55°C

**PP - Polypropylen**

hart elastisch; unzerbrechlich; umweltschonend recycelbar; mikrowelleneeignet; Gebrauchstemperatur ca. -30 °C bis ca. +75 °C  
 Pflege:  
 spülmaschineneeignet

**PP - polypropylene**

hard elastic; unbreakable; environmentally friendly recyclable; microwave safe; service temperature approx. -30 °C to approx. +75 °C  
 care:  
 dishwasher safe

**PS - Polystyrol**

starr; kratzfest; formbeständig in kochendem Wasser; Gebrauchstemperatur bis ca. +70 °C  
 Pflege:  
 spülmaschineneeignet

**PS - polystyrene**

rigid; scratch-resistant; keeps its shape in boiling water; service temperature up to approx. +70 °C  
 care:  
 dishwasher safe

**PVC - Polyvinylchlorid**

säurebeständig; schwer entflammbar; Gebrauchstemperatur ca. -50 °C bis +60 °C  
 Pflege:  
 nicht spülmaschineneeignet

**PVC - polyvinyl chloride**

acid-resistant; flame-retardant; service temperature approx. -50 °C to +60 °C  
 care:  
 not dishwasher safe

**SAN - Styrol-Acrylnitril**

gute Oberflächenhärte; temperaturwechselfest; Gebrauchstemperatur bis ca. +100 °C  
 Pflege:  
 spülmaschineneeignet

**SAN - styrene acrylonitrile**

good surface hardness; resistant to temperature changes; service temperature up to approx. +100 °C  
 care:  
 dishwasher safe

**Silikon**

hohe thermische Beständigkeit; gute Kälteflexibilität; Gebrauchstemp. ca. -70 °C bis ca. +180 °C  
 Pflege:  
 spülmaschineneeignet

**Silicone**

high thermal resistance; good low-temperature flexibility; service temperature approx. -70 °C to approx. +180 °C  
 care:  
 dishwasher safe

**Tetron**

Kunstfaser: 65% Polyester, 35% Viskose  
 Pflege:  
 Maschinenwaschbar bis 30 grad

**Tetron**

Artificial fibre: 65% polyester, 35% viscose  
 care:  
 Machine washable up to 30 degrees

**Tritan®**

starr; unzerbrechlich; absolut formbeständig; sehr hohe Chemikalienbeständigkeit; Gebrauchstemperatur ca. -30 °C bis ca. +95 °C; nicht mikrowelleneeignet  
 Pflege:  
 spülmaschineneeignet

**Tritan®**

rigid; unbreakable; keeps its shape in boiling water; very high chemical resistance; service temperature approx. -30 °C to approx. +95 °C; not microwaveable  
 care:  
 dishwasher safe

BETON  
CONCRETE

### Beton

Werkstoff Beton, coole optik; handgefertigt

Pflege:

nicht spülmaschinengeeignet

PORZELAN  
PORCELAIN

### Porzellan

hitzebeständig bis ca. +220 °C

Pflege:

spülmaschinengeeignet

SCHIEFER  
SLATE

### Schiefer

Naturschiefer versiegelt; lebensmittelecht;

Pflege:

nicht spülmaschinengeeignet

### Concrete

Concrete material, cool look; handmade

care:

not dishwasher safe

### Porcelain

heat-resistant up to approx. +220 °C

care:

dishwasher safe

### Slate

Natural slate sealed; food-safe

care:

not dishwasher safe

HOLZ  
WOOD

### Holz

lebensmittelecht; nicht spülmaschinengeeignet; naturbedingte Abweichung in Form, Farbe, Maserung und Größe; Abweichungen stellen keinen Mangel dar

Pflege:

Direkt nach dem Gebrauch sollten Holzprodukte abgespült und mithilfe einer Spülbürste gereinigt werden. Auch Spülmittel dürfen zur Reinigung verwendet werden. Wir empfehlen auf beiden Seiten zu spülen, damit im Holz keine Spannungen durch einseitige Befeuchtung entstehen. Danach gut abtrocknen und die restliche Feuchtigkeit auf einem Tuch abtropfen lassen. So können die Produkte gleichmäßig von beiden Seiten trocknen. Weichen Sie das Holzschneidbrett nicht ein und lassen Sie es auch nicht im Wasser liegen. Auch nicht in Ofennähe trocknen lassen.

Wie kann man Holzprodukte ölen?

Nicht nur die Reinigung spielt für die Produkte eine wichtige Rolle, sondern auch die Aufrechterhaltung seiner Kondition. Mit ein wenig Öl lässt sich beim Holz daher jede Menge erreichen, denn wird die Oberfläche mit Öl eingerieben, kommt es zur Schließung der Poren.

Beim Ölen sollte allerdings darauf geachtet werden, dass es sich um ein geschmacksneutrales oder geruchloses Öl handelt. Empfehlenswert sind hierbei entweder Traubenkernöl oder auch Mandelkernöl. Vorsicht: sollte man unter einer Nussallergie leiden, ist von der Benutzung des Mandelöls abzuraten). Sie können fast jedes Salatöl verwenden. Dabei gilt die Grundregel: je höher raffiniert umso besser, da es dadurch nicht so leicht ranzig wird. Ein weiteres Öl, das verwendet werden kann, ist Weissöl aus der Apotheke. Auf Olivenöl sollte verzichtet werden, denn dann kann das Brett ranzig riechen und verkleben.

So geht's: Tröpfeln Sie etwas Öl auf das Schneidbrett und verreiben Sie es gleichmäßig auf allen Seiten.

### Wood

food-safe; not dishwasher-safe; natural deviation in shape, colour, grain and size; deviations do not constitute a defect

Care:

Immediately after use, wooden products should be rinsed and cleaned with a dishwashing brush. Washing-up liquid may also be used for cleaning. We recommend rinsing on both sides so that no tensions arise in the wood due to one-sided moistening. Then dry well and let the remaining moisture drip off on a cloth. This allows the products to dry evenly from both sides. Do not soak the wooden chopping board or leave it in water. Also do not let it dry near the oven.

How to oil wooden products?

Not only cleaning plays an important role for the products, but also maintaining its condition. A little oil can therefore achieve a lot with wood, because if the surface is rubbed with oil, the pores are closed.

When oiling, however, care should be taken that the oil is tasteless or odourless. Grape seed oil or almond seed oil are recommended. Caution: if you suffer from a nut allergy, it is not advisable to use almond oil. You can use almost any salad oil. The basic rule is: the more highly refined the better, as this makes it less likely to go rancid. Another oil that can be used is white oil from the pharmacy. Olive oil should be avoided, because then the board can smell rancid and stick together.

How to do it: Drip some oil onto the chopping board and rub it evenly on all sides.





# Index

Artikel-Nr.	Prüfziffer	Seite						
<b>0</b>								
00011	7	300	00311	8	296	00568	6	428
00012	4	300	00381	1	101	00570	9	428
00013	1	304	00382	8	101	00572	3	304
00016	2	295	00383	5	101	00574	7	430
00017	9	304	00384	2	101	00576	1	430
00018	6	295	00385	9	101	00578	5	429
00019	3	295	00388	0	101	00580	8	431
00020	9	295	00389	7	108	00581	5	426
00021	6	300	00391	0	108	00582	2	427
00022	3	298	00392	7	108	00583	9	427
00023	0	300	00393	4	108	00584	6	427
00025	4	295	00394	1	108	00585	3	427
00026	1	295	00395	8	108	00586	0	429
00027	8	296	00396	5	108	00587	7	439
00029	2	296	00397	2	108	00588	4	438
00030	8	301	00398	9	108	00589	1	438
00031	5	296	00399	6	108	00590	7	438
00032	2	270	00401	6	276	00591	4	438
00033	9	267, 417	00463	4	135, 289	00592	1	439
00036	0	301	00468	9	136, 216, 288, 290, 489	00593	8	439
00037	7	299	00469	6	216, 288	00594	5	439
00040	7	469	00500	6	131, 423	00595	2	438
00042	1	469	00502	0	132, 424	00596	9	439
00046	9	135, 289	00506	8	131, 423	00597	6	439
00047	6	135, 289	00508	2	132, 424	00598	3	439
00048	3	430	00510	5	131, 423	00599	0	455
00050	6	430	00511	2	131, 423	00600	3	444
00052	0	428	00515	0	131, 423	00601	0	445
00054	4	428	00521	1	132, 424	00602	7	445
00056	8	428	00522	8	132, 424	00603	4	444
00060	5	302	00524	2	132, 424	00604	1	444
00063	6	270	00525	9	132, 424	00605	8	445
00064	3	105	00526	6	132, 424	00606	5	445
00065	0	105	00528	0	132, 424	00607	2	445
00067	4	105	00529	7	132, 424	00610	2	470, 481
00069	8	73, 304	00530	3	133, 425	00611	9	470, 481
00070	4	299	00531	0	133, 425	00612	6	470, 481
00071	1	303	00532	7	133, 425	00615	7	56, 410, 496
00074	2	301	00533	4	133, 425	00617	1	56, 410, 413
00075	9	101	00534	1	133, 425	00618	8	56, 410
00076	6	300	00535	8	133, 425	00619	5	56, 410
00078	0	302	00536	5	133, 425	00620	1	56, 410
00079	7	302	00537	2	133, 425	00621	8	56, 410
00081	0	101	00538	9	133, 425	00623	2	287
00082	7	101	00539	6	133, 425	00625	6	287
00084	1	101	00540	2	133, 425	00626	3	287
00085	8	101	00541	9	133, 425	00627	0	287
00087	2	101	00542	6	133, 425	00634	8	269, 416
00090	2	429	00543	3	133, 425	00636	2	64
00091	9	429	00547	1	131, 423	00637	9	65
00092	6	468	00548	8	131, 423	00650	8	351
00093	3	468	00549	5	131, 423	00652	2	105, 136
00094	0	468	00552	5	133, 425	00662	1	443
00098	8	468	00553	2	133, 425	00664	5	443
00099	5	468	00554	9	133, 425	00666	9	443
00106	0	469	00555	6	133, 425	00668	3	443
00110	7	468	00560	0	427	00670	6	443
00113	8	468	00561	7	292, 427	00671	3	440
			00562	4	427	00672	0	440
			00563	1	427	00673	7	440
			00564	8	427	00677	5	240
						00685	0	447
						00686	7	447
						00687	4	447
						00688	1	447
						00691	1	240
						00692	8	240
						00693	5	240
						00694	2	470
						00695	9	470
						00696	6	470
						00697	3	470
						00699	7	240, 453
						00700	0	301
						00711	6	440
						00712	3	440
						00713	0	440
						00714	7	440
						00715	4	440
						00716	1	440
						00721	5	440
						00722	2	440
						00723	9	440
						00730	7	440
						00740	6	462
						00744	4	462
						00745	1	462
						00746	8	462
						00747	5	462
						00750	5	124, 247
						00751	2	124, 247
						00752	9	124, 247
						00753	6	124, 247
						00754	3	125, 248
						00755	0	125, 248
						00756	7	125, 248
						00757	4	125, 248
						00758	1	117
						00759	8	117
						00760	4	118
						00761	1	125, 246
						00765	9	269, 416
						00766	6	267, 417
						00768	0	267, 269, 416, 417
						00771	0	464
						00772	7	258, 465
						00773	4	258
						00774	1	258
						00775	8	258
						00776	5	258
						00777	2	258
						00778	9	258
						00779	6	258, 465
						00780	2	465
						00781	9	258
						00782	6	258
						00783	3	258
						00785	7	465
						00790	1	119, 245
						00791	8	119, 245
						00792	5	119, 245
						00793	2	119, 245
						00794	9	69
						00795	6	69
						00796	3	69
						00805	2	129
						00806	9	89, 129
						00807	6	129
						00808	3	122, 249
						00809	0	123
						00810	6	120, 244
						00811	3	120, 244
						00812	0	120, 244
						00813	7	120, 244
						00814	4	120, 244
						00816	8	129
						00817	5	123
						00818	2	122, 134, 288
						00820	5	107
						00821	2	107
						00822	9	107
						00825	0	107
						00826	7	107
						00827	4	104
						00828	1	104
						00830	4	94, 107
						00831	1	442
						00832	8	442
						00833	5	442
						00834	2	442
						00835	9	125, 248
						00840	3	454
						00841	0	454
						00842	7	454
						00843	4	127, 241
						00844	1	127, 241
						00845	8	243
						00846	5	129, 243
						00864	9	128, 245
						00867	0	121, 244
						00868	7	12

01323	0	103	09091	0	35	10503	4	386	10708	3	42	10840	0	46	11044	1	75, 100, 166, 188, 324, 484
01324	7	103	09093	4	35	10504	1	386	10709	0	42	10849	3	36, 383	11048	9	100
01325	4	103	09094	1	35	10505	8	38, 387	10710	6	42	10850	9	46	11051	9	490
01332	2	103	09099	6	106	10506	5	240, 434	10711	3	42	10851	6	37, 39, 384	11052	6	490
01335	3	103	09100	9	34	10509	6	387	10712	0	42	10853	0	37, 384	11053	3	490
01338	4	103	09102	3	34	10510	2	387	10713	7	42	10855	4	38	11054	0	490
01348	3	103	09104	7	34	10511	9	387	10714	4	42	10859	2	46	11055	7	422, 492
01349	0	103	09200	6	34	10512	6	387	10715	1	42	10870	7	20, 45	11056	4	83, 186, 422, 492
01699	6	106, 271	09202	0	34	10513	3	386	10716	8	42	10871	4	20, 45	11065	6	100
01709	2	103	09204	4	34	10514	0	386	10717	5	42	10872	1	20, 45	11070	0	316, 318, 486
01710	8	103				10515	7	386	10718	2	37, 38, 384	10873	8	20, 45	11071	7	316, 318, 486
01711	5	103	1			10516	4	386	10720	5	41	10887	5	19, 495	11072	4	316, 318, 486
01712	2	103	10316	0	267, 417	10517	1	386	10721	2	51	10889	9	495	11073	1	117, 486
01738	2	103	10318	4	416	10520	1	52	10722	9	51	10890	5	19, 495	11074	8	486
01748	1	103	10319	1	416	10525	6	387	10738	0	51	10907	0	46	11075	5	25, 28, 112, 117, 487
02038	2	296	10320	7	416	10526	3	387	10739	7	51	10910	0	49	11100	4	29, 100
02039	9	296	10321	4	269, 416	10527	0	387	10741	0	51	10911	7	49	11101	1	29, 30, 34, 496
02310	9	102	10322	1	415	10528	7	387	10742	7	51	10912	4	49	11110	3	100
02311	6	102	10323	8	415	10529	4	387	10748	9	53	10913	1	49	11118	9	15
02312	3	102	10325	2	415	10530	0	387	10749	6	53	10914	8	49	11119	6	15, 204
03038	1	274	10326	9	415	10531	7	387	10750	2	45	10915	5	47	11150	9	99
03039	8	274	10327	6	415	10532	4	387	10756	4	46	10916	2	47	11155	4	99
03098	5	274	10328	3	414	10533	1	387	10757	1	46	10917	9	47	11244	5	348
03099	2	274	10329	0	414	10534	8	387	10758	8	46	10921	6	48	11295	7	99
03622	2	97, 217	10330	6	414	10535	5	387	10759	5	46	10922	3	48	11300	8	99
03623	9	97, 217	10331	3	414	10536	2	387	10762	5	50	10923	0	48	11305	3	99, 484
03824	0	101	10332	0	414	10560	7	385	10764	9	50	10924	7	48	11442	5	95
04010	6	275	10334	4	414	10561	4	385	10766	3	50	10925	4	48	11444	9	95
04011	3	275	10335	1	414	10562	1	385	10769	4	53	10926	1	48	11446	3	95
04015	1	275	10336	8	414	10563	8	385	10770	0	52	10927	8	48	11455	5	95
04017	5	275	10350	4	414	10564	5	385	10771	7	53	10928	5	48	11495	1	78, 80
04020	5	274	10351	1	414	10565	2	385	10775	5	53	10990	2	57, 419	11496	8	78
04021	2	274	10352	8	49	10566	9	385	10776	2	53	10991	9	57, 419	11497	5	78
04446	3	293	10353	5	49	10567	6	385	10777	9	19, 31, 32, 33, 42, 496	10992	6	57, 419	11498	2	78
06401	0	105, 492	10354	2	49	10568	3	385	10778	6	62	10993	3	58	11499	9	78
06501	7	491	10355	9	415	10569	0	385	10781	6	496	10994	0	58	11503	3	29
06503	1	105	10360	3	415	10570	6	385	10782	3	28, 112, 496	10995	7	57, 419	11505	7	29
06504	8	491	10361	0	415	10571	3	385	10788	5	41	10996	4	57, 419	11510	1	28
06506	2	491	10362	7	415	10572	0	385	10789	2	41	11000	7	100	11512	5	29
06510	9	105, 122, 134, 217, 288, 491	10400	6	37, 384	10573	7	385	10791	5	25, 26, 27, 28, 29, 30, 496	11008	3	17, 26, 29, 315, 487	11514	9	28
06512	3	75, 122, 129, 217, 491	10403	7	37, 384	10574	4	385	10792	2	51	11010	6	25, 26, 28, 29, 170, 183, 315, 487	11522	4	81
06515	4	491	10404	4	37, 384	10575	1	385	10795	3	41	11013	7	486	11523	1	80, 81
06517	8	491	10405	1	37, 384	10576	8	385	10796	0	41	11016	8	129, 487	11524	8	80
06519	2	129, 135, 180, 289, 290, 488	10409	9	37, 384	10577	5	385	10800	4	41	11018	2	17, 315, 487	11526	2	80
06520	8	75, 122, 129, 134, 135, 180, 288, 289	10410	5	37, 384	10578	2	385	10801	1	42	11020	5	100	11527	9	80
06521	5	129, 135, 180, 289, 290, 489	10411	2	37, 384	10579	9	385	10802	8	43	11021	2	170, 183, 485	11528	6	81
06525	3	180, 290, 489	10415	0	38	10585	0	385	10803	5	42	11022	9	324, 485	11529	3	81
06701	1	105, 492	10416	7	38	10586	7	385	10804	2	42	11026	7	316, 485	11533	0	30
08201	4	101	10417	4	38	10587	4	385	10807	3	42	11027	4	170, 316, 318, 324, 485	11538	5	30
09010	1	102	10418	1	38	10588	1	385	10808	0	42	11028	1	316, 485	11540	8	26
09013	2	102, 487	10422	8	39	10589	8	385	10809	7	42	11032	8	100	11541	5	26
09023	1	488	10424	2	39, 40	10608	6	42	10812	7	42	11038	0	100	11542	2	27
09080	4	106	10426	6	39, 40	10661	1	19, 31, 32, 496	10814	1	42	11040	3	100	11543	9	27
09082	8	30	10427	3	40	10663	5	45	10825	7	46	11041	0	100, 166, 170, 188, 484	11546	0	25
09083	5	30	10430	3	39	10668	0	62	10830	1	45	11042	7	100, 166, 183, 188, 318, 324	11547	7	25
09090	3	35	10435	8	40	10690	1	52, 118	10833	2	45	11043	4	100, 166, 188, 484	11555	2	316
			10440	2	44	10691	8	52	10836	3	20, 44				11556	9	93
			10440	2	44	10700	7	41	10837	0	20, 44				11557	6	84
			10450	1	36, 383	10701	4	42	10838	7	20, 44				11558	3	84
			10451	8	36, 383	10703	8	42	10839	4	20, 44						
			10500	3	386	10704	5	42									
			10501	0	39, 40, 386	10707	6	42									
			10502	7	386												

11563	7	58	11780	8	141	11973	4	62	12397	7	335, 337	15350	9	490	23642	4	105
11572	9	93	11781	5	141	11974	1	62	12398	4	337	15351	6	490			
11573	6	93	11795	2	79	11975	8	60	12399	1	337	15400	1	156	<b>3</b>		
11574	3	58	11805	8	60	11977	2	364	12403	5	338	15401	8	156	30000	2	74
11575	0	58	11807	2	60	11978	9	360	12404	2	336	15402	5	156	30001	9	74
11576	7	58	11810	2	32	11979	6	364	12483	7	338	15403	2	156	30002	6	74
11595	8	77, 81	11811	9	31, 32	11980	2	79	12484	4	338	15404	9	156	30020	0	74
11596	5	77	11812	6	31	11981	9	79	12879	8	304, 495	15416	2	156	30021	7	74
11597	2	77	11813	3	31	11986	4	79	12940	5	14	15417	9	156	30045	3	467
11598	9	77	11815	7	32	11998	7	138, 295, 367	12941	2	14	15418	6	156	30046	0	467
11599	6	77	11816	4	31, 32	11999	4	138, 295, 367	12990	0	404	15419	3	156	30047	7	467
11607	8	93	11817	1	31	12000	6	100	13122	4	104	15420	9	156	30048	4	467
11616	0	24	11818	8	31	12008	2	487	13377	8	469	15421	6	156	30049	1	467
11617	7	24	11840	9	59	12010	5	487	13378	5	469	15424	7	156	30050	7	19
11619	1	112	11841	6	59	12065	5	100	13379	2	469	15425	4	156	30052	1	19
11620	7	22, 330	11845	4	33	12100	3	100	13380	8	111, 251	15449	0	156	30057	6	467
11621	4	22, 330	11846	1	31, 32	12225	3	345	13382	2	104	15450	6	156	30058	3	468
11622	1	23, 331	11847	8	32	12232	1	346	13385	3	104	15451	3	156	30059	0	467
11623	8	22, 330	11848	5	31, 32	12233	8	344	13622	9	104	15452	0	156	30061	3	467
11625	2	273	11849	2	32	12235	2	345	13940	4	14	15453	7	156	30062	0	467
11626	9	22, 330	11859	1	495	12236	9	344	13941	1	14	15454	4	156	30063	7	467
11627	6	22, 330	11865	2	78, 495	12243	7	348	13955	8	15	15455	1	156	30065	1	369, 471
11628	3	23, 331	11866	9	495	12244	4	348	13965	7	61	15456	8	156	30066	8	369, 471
11629	0	22, 330	11868	3	31, 32, 78, 495	12245	1	344	13966	4	71	15457	5	156	30067	5	369, 471
11645	0	28, 112	11875	1	33, 77, 495	12249	9	343, 344	13980	0	19	15458	2	156	30068	2	369, 471
11647	4	141, 272	11878	2	31, 32, 33, 77, 495	12270	3	76, 341	13981	7	19	15460	5	156	30069	9	369, 471
11648	1	141, 272	11879	9	304, 495	12271	0	76, 341	13987	9	21, 61	15461	2	156	30070	5	369, 471
11649	8	272	11881	2	474	12272	7	76, 341	13990	9	18	15462	9	156	30071	2	369, 471
11650	4	273	11884	3	65	12285	7	349	13995	4	21	15467	4	156	30075	0	369, 470
11651	1	273	11885	0	65	12287	1	47, 348, 349	14940	3	14	15473	5	157	30076	7	369, 470
11671	9	47, 348	11887	4	92	12290	1	350	14941	0	14	15474	2	157	30077	4	369, 470
11672	6	47, 348	11888	1	92	12291	8	337, 338, 349	14953	3	17	15475	9	157	30078	1	369, 470
11675	7	344	11889	8	92	12292	5	350	14954	0	17	15477	3	157	30108	5	293, 426
11683	2	350	11891	1	92	12294	9	350	14956	4	17	15485	8	157	30110	8	293, 426
11705	1	52, 118	11901	7	346	12295	6	76, 334, 336-338, 340-341, 349	14965	6	61	15486	5	157	30111	5	109, 421
11706	8	52, 118	11910	9	346	12296	3	336, 349	14966	3	71	15501	5	157	30112	2	109, 421
11711	2	70	11915	4	345	12299	4	349	14970	0	16	15502	2	157	30113	9	109, 421
11712	9	70	11916	1	345	12300	7	343	14980	9	19	15503	9	91, 157	30114	6	110, 422
11713	6	70	11917	8	345	12310	6	348	14981	6	19	15504	6	157	30115	3	109, 421
11714	3	70	11921	5	294	12322	9	339	14987	8	21, 61	15505	3	157	30116	0	109, 421
11715	0	23, 331	11922	2	294	12323	6	339	14990	8	18	15506	0	76, 91, 157, 341	30117	7	109, 421
11716	7	23, 331	11930	7	296	12324	3	340	14995	3	21	15513	8	98, 157	30118	4	110, 421
11717	4	23, 331	11931	4	296	12325	0	340	15100	0	154	15514	5	98, 157	30119	1	110, 421
11718	1	23, 331	11940	6	368	12329	8	342	15101	7	154	15620	3	75	30120	7	110, 210
11720	4	139	11945	1	365	12330	4	342	15110	9	154	15621	0	75	30121	4	110, 210
11721	1	22, 330	11946	8	365	12335	9	342	15111	6	154	15622	7	75	30126	9	110, 422
11722	8	22, 330	11947	5	365	12336	6	342	15112	3	154	15623	4	75	30130	6	111, 251, 420
11723	5	22, 330	11948	2	137, 366	12337	3	342	15113	0	154	15921	1	270	30131	3	111, 251, 420
11724	2	22, 330	11949	9	137, 366	12338	0	342	15116	1	154	15925	9	270	30132	0	111, 251, 420
11726	6	246, 273	11950	5	368	12350	2	343	15200	7	154	15926	6	270	30133	7	111, 251, 420
11727	3	128, 246, 273	11951	2	137, 366	12352	6	335	15201	4	154	15929	3	15	30134	4	111, 251
11730	3	139	11952	9	137, 366	12353	3	335	15215	1	154	17910	3	15	30140	5	109, 251, 420
11740	2	68	11954	3	138, 367	12354	0	335	15216	8	154	17922	6	15	30141	2	109, 251, 420
11762	4	140	11955	0	138, 367	12360	1	345	15217	5	154	18121	2	492	30142	9	109, 251, 420
11763	1	140	11960	4	138, 367	12366	3	335, 338	15320	2	157, 328	18380	3	488	30148	1	109, 422
11765	5	140	11965	9	137, 366	12370	0	335	15322	6	157, 328	18387	2	27, 315, 488	30149	8	109, 422
11767	9	139	11966	6	137, 312, 366	12371	7	335	15324	0	157, 328	18388	9	27, 29-30, 217, 315, 488	30200	6	326
11768	6	139	11969	7	92	12372	4	335	15326	4	328	18389	6	16, 315	30206	8	327
11770	9	140	11970	3	60	12373	9	338	15331	8	328	18621	7	492	30207	5	327
11771	6	140	11971	0	62	12393	9	338	15332	5	328				30208	2	327
11775	4	58	11972	7	62	12394	6	336	15334	9	328				30210	5	326
11776	1	58				12396	0	337	15335	6	328				30220	4	326
11778	5	140							15348	6	154				30230	3	326

30240	2	326	30444	4	320	35734	1	292	36125	6	228, 379	40224	9	313	40446	5	265
30250	1	326	30445	1	320	35912	3	293	36126	3	379	40225	6	312	40450	2	261
30260	0	481	30446	8	320	36003	7	373	36127	0	228, 379	40226	3	313	40453	3	265
30263	1	481	30447	5	320	36004	4	373	36130	0	54, 382	40227	0	312	40454	0	265
30270	9	326	30450	5	320	36010	5	395	36233	8	292	40228	7	313	40455	7	262
30276	1	327	30451	2	320	36011	2	395	36323	6	292	40229	4	312	40457	1	262
30277	8	327	33206	5	71	36013	6	406	38202	2	101	40230	0	313	40458	8	262
30279	2	319	33207	2	71	36015	0	405				40240	9	313	40460	1	262
30280	8	319	33208	9	85	36017	4	406	4			40242	3	313	40461	8	262, 263
30281	5	319	33209	6	85	36020	4	373	40007	8	294, 317	40243	0	312	40462	5	262, 263
30282	2	319	33210	2	84	36021	1	373	40009	2	294, 317	40244	7	313	40463	2	262
30283	9	319	33211	9	86	36025	9	372	40010	8	294, 317	40245	4	312	40464	9	262
30285	3	319	33212	6	86	36026	6	372	40011	5	294, 317	40246	1	313	40470	0	263
30286	0	319	33214	0	86	36028	0	372	40012	2	294, 317	40247	8	312	40472	4	263
30299	0	311	33215	7	86	36030	3	379	40013	9	294, 317	40249	2	312	40474	8	263
30310	2	326	33216	4	86	36032	7	380	40110	5	102	40260	7	313	40476	2	263
30325	6	87	33217	1	86	36033	4	405	40115	0	102	40262	1	313	40478	6	263
30331	7	23, 331	33219	5	86	36034	1	380	40130	3	294, 317	40263	8	313	40480	9	263
30332	4	374	33220	1	86	36037	2	405	40131	0	294, 317	40264	5	313	40482	3	264
30333	1	382	33232	4	93	36038	9	379	40132	7	314	40270	6	313	40485	4	265
30334	8	82	33238	6	87	36044	0	376	40135	8	314	40272	0	313	40486	1	268, 418
30335	5	85	33246	1	79, 286	36045	7	376	40137	2	314	40274	4	313	40487	8	268, 418
30336	2	83	33248	5	87	36046	4	376	40139	6	314	40276	8	313	40488	5	269, 416
30337	9	83, 324	33249	2	96	36047	1	376	40140	2	314	40290	4	16, 312	40490	8	268, 418
30338	6	83	33250	8	96	36048	8	378	40144	0	93, 314	40291	1	16, 312	40494	6	268, 418
30339	3	82	33251	5	96	36052	5	378	40148	8	314	40292	8	16, 312	40498	4	418
30340	9	321	33252	2	96, 184	36053	2	378	40149	5	315	40293	5	16, 312	40499	1	418
30341	6	321	33255	3	74, 98	36054	9	378	40150	1	315	40294	2	16, 315	40500	4	257
30345	4	321	33256	0	74, 98	36055	6	373	40152	5	314	40295	9	16, 315	40501	1	257
30346	1	321	33260	7	96	36056	3	378	40153	2	315	40296	6	311	40503	5	257
30347	8	321	33261	4	96	36057	0	377	40159	4	314	40297	3	311	40504	2	126, 257
30348	5	321	33262	1	96	36062	4	380	40179	2	317	40299	7	311	40505	9	257
30350	8	321	33269	0	69, 96	36063	1	380	40182	2	317	40300	0	265	40506	6	268, 417
30351	5	321	33270	6	69, 96	36066	2	373	40185	3	236	40310	9	261	40507	3	257
30355	3	320	33271	3	69, 96	36068	6	374	40186	0	106, 233	40311	6	261	40508	0	267, 417
30356	0	126, 320	33272	0	96	36069	3	374	40187	7	106, 233	40312	3	261	40509	7	267, 417
30357	7	322, 434	33273	7	96	36074	7	379	40188	4	106, 233	40313	0	261	40510	3	268, 418
30358	4	322, 434	33280	5	98	36075	4	382	40189	1	327	40320	8	261	40511	0	266
30360	7	321	33281	2	98	36077	8	376	40190	7	327	40330	7	264	40516	5	240, 393
30361	4	321	33282	9	97, 184, 216, 287	36087	7	377	40191	4	314	40331	4	264	40517	2	240, 393
30370	6	321				36090	7	381	40192	1	314	40333	8	264	40535	6	253
30371	3	321	33288	1	94	36095	2	55, 377	40193	8	314	40404	5	272	40536	3	253
30380	5	322	33292	8	135, 289	36096	9	55, 377	40194	5	314	40405	2	272	40537	0	253
30385	0	322	33293	5	135, 289	36099	0	381	40195	2	314	40410	6	260	40538	7	254
30390	4	322	33294	2	135, 136, 289, 290, 489	36100	3	55, 377	40196	9	314	40411	3	260	40539	4	254
30395	9	322				36101	0	55, 377	40198	3	316	40412	0	260	40540	0	254
30396	6	322	33295	9	135, 136, 289, 290, 489	36102	7	404	40200	3	291	40413	7	260	40541	7	255
30410	9	324				36103	4	404	40201	0	291	40414	4	266	40544	8	257
30411	6	324				36104	1	381	40202	7	291	40415	1	261	40545	5	257, 265
30412	3	324	33296	6	135, 289	36105	8	381	40203	4	291	40416	8	256	40546	2	253
30413	0	324	33297	3	135, 289	36106	5	55, 375	40204	1	291	40417	5	256	40547	9	253
30414	7	324	33300	0	66	36107	2	55, 375	40205	8	291	40418	2	256	40548	6	253
30415	4	324	33301	7	67	36108	9	55, 375	40206	5	291	40424	3	264	40549	3	255
30416	1	324	33302	4	66	36109	6	55, 375	40207	2	292	40425	0	303	40550	9	255
30420	8	325	33303	1	67	36111	9	55, 375	40208	9	291	40435	9	259	40551	6	256
30421	5	325	33304	8	66, 67, 97	36112	6	55, 375	40210	2	318	40436	6	259	40552	3	256
30422	2	325	33305	5	97, 118	36115	7	372	40211	9	318	40437	3	259	40553	0	255
30423	9	325	35065	6	350	36116	4	374	40212	6	318	40438	0	259	40554	7	255
30424	6	325	35343	5	350	36120	1	375	40214	0	318	40439	7	259	40555	4	126, 253, 266
30440	6	320	35711	2	293	36121	8	375	40216	4	318	40440	3	261	40556	1	126, 253, 266
30441	3	320	35716	7	52, 118, 293	36122	5	381	40220	1	313	40441	0	261	40557	8	254
30442	0	320	35720	4	292	36123	2	381	40222	5	313	40442	7	259	40558	5	254
30443	7	320	35730	3	292	36124	9	381	40223	2	312	40445	8	265	40570	7	252

40571	4	252	40667	4	270, 279		60044	7	278	71002	3	451, 474	74721	0	463			
40572	1	252	40668	1	270, 279	<b>5</b>	60045	4	278	71003	0	451, 474	74722	7	463			
40573	8	252	40669	8	279	50002	0	84	60046	1	278	71004	7	451, 474	74731	9	466	
40574	5	252	40670	4	111, 114, 126, 236, 251, 420	50205	5	309	60270	0	102	71005	4	451, 474	74750	0	418	
40575	2	252				50210	9	309	60310	3	102	71006	1	451, 474	75001	2	271	
40576	9	252	40676	6	138, 230, 367	50305	2	309	60502	2	277	71400	7	426	75002	9	271	
40577	6	252	40680	3	230	50400	4	309	60503	9	277	71421	2	477, 496	75600	7	451	
40600	1	234	40681	0	230	50600	8	310	60505	3	277	71430	4	418	75800	1	450	
40601	8	114, 234	40685	8	128, 236, 245	50601	5	310	60508	4	277	71431	1	403, 472	75801	8	449	
40602	5	234	40686	5	128, 236, 246	50602	2	310	60509	1	276	71433	5	426	75803	2	451	
40603	2	234	40690	2	237, 323	50603	9	310	60510	7	276	71440	3	364	75804	9	451	
40604	9	237, 323	40691	9	237, 323	50605	3	310	60511	4	276	71441	0	365	75805	6	407	
40605	6	235	40692	6	237, 323	50606	0	310	60512	1	276	71460	1	299	75806	3	450	
40606	3	235	40693	3	237, 323	50607	7	310	60520	6	277	71461	8	299	75807	0	450	
40607	0	235	40694	0	237, 323	50608	4	310	60521	3	277	71470	0	304	75808	7	452	
40610	0	234	40695	7	237, 323	50612	1	310	60522	0	277	71471	7	304	75809	4	452	
40611	7	234	40700	8	229	50620	6	311	60523	7	277	71480	9	304	75810	0	449	
40612	4	234	40701	5	229	50621	3	311	60524	4	277	71487	8	302	75820	9	407, 452	
40613	1	234	40702	2	229	50622	0	311	60525	1	277	71489	2	302	75821	6	407, 452	
40616	2	235	40703	9	229	50623	7	311	60526	8	277	71490	8	304	75822	3	449	
40617	9	235	40704	6	229	50624	4	311	60527	5	277	71491	5	304	75823	0	449	
40618	6	235	40705	3	229	50625	1	311	60528	2	277	71492	2	301	75824	7	449	
40620	9	234	40706	0	229	50626	8	311	60530	5	276	71493	9	301	75825	4	448	
40621	6	234	40707	7	229	50627	5	311	60531	2	276	71494	6	301	75830	8	448	
40622	3	234	40708	4	229	50630	5	310	60534	3	276	71495	3	303	75831	5	448	
40623	0	234	40709	1	229	50631	2	310	60535	0	278	71496	0	298	75832	2	448	
40624	7	234	40710	7	229, 235	50644	2	318	60536	7	278	71497	7	298	75833	2	448	
40625	4	114, 234	40711	4	229, 235	50702	9	309	60537	4	278	71498	4	302	75840	7	446	
40626	1	234	40712	1	228	50707	4	309	60540	4	276	71499	1	302	75841	4	446	
40627	8	234	40713	8	228	50710	4	308	60541	1	276	71510	3	299	75842	1	446	
40628	5	234	40720	6	238	50712	8	308	60542	8	276	71512	7	299	75843	8	446	
40629	2	234	40721	3	238	50722	7	309	60543	5	278	71513	4	299	75844	5	446	
40630	8	235	40722	0	229, 238	50800	2	310	60544	2	278	71516	5	299	75850	6	448	
40631	5	235	40723	7	229, 238	50801	9	310	60545	9	278	71520	2	298	75851	3	448	
40632	2	280	40724	4	238	50802	6	310	60546	6	278	71521	9	297	75852	0	448	
40633	9	280	40725	1	238	50803	3	310	60551	0	277	71522	6	297	75853	7	407, 448	
40634	6	280	40726	8	229, 238	50805	7	310	60552	7	277	71523	3	297	75854	4	407, 448	
40635	3	280	40727	5	229, 238	50806	4	310	60554	1	277	71527	1	297	75855	1	407, 448	
40636	0	280	40728	2	238	50807	1	310	61190	0	102	71528	8	297	75900	8	441	
40637	7	280	40729	9	238	50808	8	310	61280	8	102	71529	5	297	75902	2	441	
40638	4	280	40730	5	232	50815	6	310	61400	0	102	71531	8	298	75903	9	441	
40640	7	235, 269, 415	40731	2	232	50817	0	310	65060	2	271, 347	73502	6	478	75904	6	441	
40642	1	233	40732	9	232	50823	1	310	65061	9	347	73505	7	478	75906	0	441, 481	
40643	8	233	40733	6	232	50905	4	308	65062	6	347	73506	4	478	75907	7	441	
40644	5	233	40734	3	232	50908	5	308	65070	1	394	73507	1	478, 479	75908	4	441	
40645	2	280	40735	0	232	50910	8	308	65071	8	394	73508	8	478	75912	1	441	
40646	9	280	40736	7	232	50913	9	308	65072	5	394	73509	5	478	77315	8	474	
40647	6	280	40737	4	232	50915	3	308	66900	0	329, 435	73510	1	478	77338	7	466	
40654	4	236	40738	1	232	50918	4	308	66901	7	329, 435	73511	8	478	77350	9	472, 481	
40655	1	111, 236, 251, 420	40740	4	233				66902	4	329, 435	73513	2	478	79000	1	72	
40656	8	111, 236, 251, 420	40741	1	233	<b>6</b>	60002	7	277	66904	8	472	73515	6	479	79001	8	72
40657	5	236	40742	8	233	60012	6	277	66905	5	433	73750	1	481	79002	5	72	
40658	2	236	40752	7	491	60014	0	277	66906	2	433	74201	7	462	79003	2	72	
40659	9	236	40760	2	239	60015	7	277	66910	9	305, 432, 497	74402	8	465	79004	9	72	
40660	5	233	40761	9	239	60016	4	277	66911	6	305, 432, 497	74404	2	465	79005	6	72	
40661	2	279	40762	6	239	60018	8	277	66912	3	305, 432, 497	74700	5	463	79006	3	72	
40662	9	279	40763	3	239	60019	5	277	66913	0	305, 432, 497	74701	2	463	79007	0	72	
40663	6	279	40764	0	239	60037	9	276	66914	7	305, 432, 497	74702	9	463	79553	2	84	
40664	3	279	40765	7	239	60038	6	276	66915	4	305, 432, 497	74703	6	463				
40665	0	279	40766	4	239	60040	9	276	66916	1	305, 432, 497	74705	0	463	<b>8</b>			
40666	7	279	40767	1	239	60041	6	277	66917	8	305, 432, 497	74706	7	463	80023	6	356	
			40768	8	239	60042	3	276	<b>7</b>			74707	4	464	80024	3	356	
									71001	6	451, 474	74708	1	465	80025	0	356	

80026	7	356	81795	1	355	82073	9	359	82277	1	361	83434	7	207, 363	83720	1	197
80027	4	356	81796	8	360	82074	6	359	82278	8	361	83437	8	214	83721	8	196
80028	1	356	81800	2	353	82076	0	359	82279	5	361	83438	5	214	83722	5	197
80029	8	356	81801	9	353	82077	7	359	82280	1	361	83440	8	214	83723	2	196
81000	6	353	81802	6	353	82078	4	359	82281	8	361	83441	5	214	83724	9	197
81095	2	353	81804	0	353	82081	4	359	82300	6	361	83443	9	214	83725	6	196
81100	3	353	81806	4	353	82100	2	361	82301	3	361	83450	7	208	83726	3	197
81101	0	353	81850	7	354	82101	9	357	82306	8	361	83451	4	208, 225	83727	0	196
81102	7	353	81891	0	355	82104	0	357	82307	5	281	83452	1	208	83728	7	197
81104	1	353	81895	8	355	82106	4	357	82308	2	281	83453	8	208	83730	0	197
81106	5	353	81901	6	354	82108	8	357	82309	9	281	83454	5	208	83732	4	197
81108	9	353	81902	3	354	82110	1	357	82310	5	79, 284, 286	83455	2	208	83735	5	196
81109	6	353	81903	0	354	82112	5	357	82312	9	79, 128, 245, 284, 286	83466	8	208, 210	83739	3	196
81116	4	351	81904	7	354	82113	2	357	82314	3	79, 284, 286	83467	5	208	83740	9	198
81117	1	356	81905	4	354	82114	9	357	82316	7	246, 285	83468	2	208	83742	3	198
81118	8	356	81906	1	354	82116	3	357	82318	1	286	83469	9	208	83744	7	198
81191	1	355	81907	8	354	82117	0	357	82319	8	286	83479	8	207, 363	83748	5	225, 362
81195	9	355	81908	5	354	82118	7	357	82328	0	61, 64	83480	4	207, 363	83749	2	225, 362
81198	0	360	81909	2	354	82119	4	357	82328	0	61, 64	83481	1	68, 207, 363	83750	8	225, 362
81199	7	360	81910	8	354	82120	0	357	82338	9	286	83482	8	207, 363	83751	5	362
81200	0	353	81911	5	354	82122	4	357	82345	7	284	83484	2	208	83752	2	225, 362
81201	7	353	81996	2	356	82123	1	357	82346	4	284	83486	6	220	83753	9	225, 362
81202	4	353	81997	9	356	82128	6	357	82347	1	284	83487	3	220	83754	6	225, 362
81204	8	353	81998	6	356	82129	3	357	82350	1	125, 248, 285	83488	0	429	83755	3	225, 362
81206	2	353	81999	3	356	82130	9	357	82351	8	125, 248, 285	83489	7	429	83756	0	225, 362
81208	6	353	82001	2	225, 358, 362	82132	3	357	82352	5	284	83490	3	207, 363	83757	7	225, 362
81209	3	353	82003	6	358	82134	7	357	82354	9	285	83491	0	68, 207, 363	83758	4	225, 362
81292	5	355	82004	3	358	82136	1	357	82355	6	15, 360	83492	7	207, 363	83759	1	225, 362
81295	6	355	82005	0	358	82137	8	357	82356	3	15, 360	83498	9	210	83760	7	224, 363
81296	3	360	82006	7	358	82138	5	357	82357	0	15, 360	83499	6	210	83761	4	224, 363
81300	7	353	82007	4	358	82140	8	357	82359	4	285	83500	9	208	83762	1	224, 363
81302	1	353	82008	1	358	82142	2	357	82360	0	282	83514	6	208	83763	8	224, 363
81304	5	353	82010	4	358	82150	7	357	82361	7	282	83592	4	207, 363	83764	5	224, 363
81306	9	353	82012	8	358	82151	4	357	82362	4	283	83597	9	207, 363	83765	2	224, 363
81308	3	353	82013	5	225, 358, 362	82159	0	357	82363	1	283	83600	6	186, 210, 494	83766	9	224, 363
81391	5	355	82014	2	358	82200	9	361	82370	9	285	83601	3	183, 186, 210, 494	83768	3	224, 363
81395	3	355	82016	6	358	82210	8	338, 340	82371	6	285	83603	7	209, 494	83769	0	224, 363
81400	4	353	82017	3	358	82215	3	338, 340	82394	5	286	83604	4	209, 494	83772	0	224, 363
81401	1	353	82018	0	358	82239	9	65, 282, 283	82395	2	286	83605	1	213, 494	83773	7	224, 363
81402	8	353	82019	7	225, 358, 362	82240	5	65, 282, 283	82419	5	368, 477	83606	8	213, 494	83777	5	213, 239
81404	2	353	82020	3	358	82241	2	282	82420	1	368	83607	5	213, 494	83780	5	213, 239
81406	6	353	82022	7	358	82242	9	282	82440	9	368, 480	83610	5	429	83781	2	213, 237, 239, 323
81408	0	353	82023	4	358	82243	6	65	82441	6	368, 480	83611	2	429	83782	9	213, 239
81492	9	355	82028	9	358	82244	3	65	83310	4	73	83612	9	429	83783	6	213, 239
81495	0	355	82029	6	225, 358, 362	82245	0	283	83311	1	73	83613	6	429	83785	0	203
81502	5	353	82030	2	358	82246	7	283	83401	9	207, 363	83615	0	88	83787	4	203
81504	9	353	82032	6	358	82250	4	64	83402	6	207	83616	7	430	83788	1	203
81506	3	353	82034	0	358	82251	1	64	83403	3	207	83648	8	220	83789	8	203
81591	9	355	82036	4	358	82252	8	64	83404	0	207	83649	5	220	83790	4	203
81595	7	355	82037	1	225, 358, 362	82253	5	64	83405	7	207	83696	9	33, 212	83798	0	213, 239
81602	2	353	82038	8	358	82255	9	63	83406	4	207	83697	6	33, 212	83799	7	203
81604	6	353	82040	1	358	82256	6	63	83407	1	207	83698	3	33, 212	83800	0	202, 221
81606	0	353	82042	5	358	82257	3	63	83408	8	208	83699	0	33, 212	83801	7	218, 351
81608	4	353	82050	0	358	82265	8	63	83409	5	208	83700	3	19, 33, 212	83803	1	218, 351
81692	3	355	82051	7	358	82266	5	63	83410	1	208	83701	0	19, 33, 212	83808	6	202, 221
81695	4	355	82059	3	358	82267	2	63	83414	9	208, 210	83702	7	19, 33, 212	83828	4	202, 204
81700	5	353	82064	7	359	82270	2	361	83415	6	208	83703	4	19, 33, 212	83830	7	202, 204
81701	2	353	82065	4	359	82271	9	361	83417	0	207	83704	1	33, 212	83842	0	220
81702	9	353	82066	1	359	82272	6	361	83418	7	207	83705	8	33, 212	83843	7	220
81704	3	353	82068	5	359	82273	3	361	83419	4	208	83712	6	195	83848	2	218
81706	7	353	82069	2	359	82274	0	361	83424	8	220	83716	4	196	83851	2	218
81707	4	353	82070	8	359	82275	7	361	83426	2	220	83718	8	197	83867	3	73
81791	3	355	82072	2	359	82276	4	361	83433	0	207, 363						

83868	0	73	83994	6	186	84209	0	173	84446	9	222	84587	9	182	84825	2	168
83869	7	208, 217	84018	8	223, 239	84215	1	213	84448	3	222	84589	3	182	84826	9	168
83878	9	204	84020	1	218	84216	8	213	84449	0	222	84590	9	182	84827	6	168
83879	6	204	84021	8	218	84217	5	201, 223	84450	6	222	84592	3	183	84828	3	168
83880	2	212	84035	5	218	84220	5	213	84452	0	222	84593	0	183	84829	0	168
83881	9	212	84040	9	217	84221	2	212	84454	4	222	84605	0	181	84830	6	169
83884	0	208	84041	6	217	84230	4	199	84456	8	222	84606	7	181	84831	3	169
83887	1	219	84042	3	217	84231	1	199	84458	2	222	84607	4	181	84835	1	169
83888	8	219	84043	0	217	84232	8	199	84460	5	220	84608	1	181	84836	8	169
83889	5	219	84045	4	131, 423	84233	5	199	84462	9	203	84609	8	181	84837	5	169
83890	1	135, 216, 288	84046	1	15, 210	84244	1	186, 209	84464	3	203	84610	4	181	84860	3	73
83891	8	135, 216, 288	84047	8	15, 210	84245	8	186, 209	84466	7	203	84611	1	181	84861	0	73
83892	5	135, 216, 288	84048	5	15, 210	84251	9	110, 422	84470	4	221, 239	84612	8	181	84862	7	73
83893	2	216, 288	84100	0	190	84253	3	110, 422	84471	1	221, 239	84613	5	181	84863	4	73
83897	0	218, 351	84101	7	190	84256	4	171	84472	8	221, 239	84614	2	181	84875	7	189
83900	7	205	84103	1	192	84257	1	187	84490	2	211	84671	5	159	84876	4	189
83901	4	205	84104	8	192	84258	8	187	84491	9	211	84672	2	159	84900	6	193
83902	1	205	84105	5	192	84259	5	187	84492	6	211	84673	9	159	84901	3	193
83903	8	205	84106	2	192	84265	6	173	84509	1	164	84674	6	160	84902	0	193
83904	5	205	84107	9	191	84266	3	171	84510	7	164	84675	3	160	84903	7	193
83905	2	205	84108	6	191	84268	7	171	84511	4	164	84676	0	160	84904	4	194
83906	9	205	84109	3	191	84269	4	171	84512	1	164	84677	7	160	84905	1	194
83907	6	205	84110	9	191	84295	3	213	84514	5	164	84678	4	160	84906	8	194
83908	3	205	84111	6	191	84300	4	225, 362	84515	2	164	84680	7	161	84907	5	194
83909	0	205	84112	3	191	84301	1	225, 362	84517	6	164	84681	4	161	84908	2	194
83910	6	206	84113	0	191	84302	8	225, 362	84519	0	166	84682	1	161	84909	9	194
83911	3	206	84115	4	191	84303	5	225, 362	84520	6	166	84683	8	161	84910	5	194
83912	0	204, 206	84116	1	191	84304	2	225, 362	84521	3	166	84684	5	162	84911	2	194
83913	7	204, 206	84117	8	192	84305	9	225, 362	84522	0	166	84685	2	162	84912	9	194
83914	4	206	84118	5	192	84306	6	225, 362	84523	7	165	84686	9	162	84920	4	179
83915	1	206	84119	2	192	84307	3	225, 362	84524	4	165	84687	6	162	84921	1	179
83916	8	206	84125	3	200	84308	0	225, 362	84525	1	165	84688	3	162	84922	8	179
83917	5	206	84126	0	200	84309	7	225, 362	84526	8	165	84689	0	162	84923	5	179
83918	2	206	84128	4	200, 219	84310	3	225, 362	84528	2	165	84690	6	162	84924	2	179
83919	9	206	84130	7	201	84311	0	225, 362	84529	9	165	84728	6	192	84925	9	179
83920	5	33, 69, 206, 212, 214, 494	84131	4	201	84329	5	167	84530	5	165	84729	3	192	84926	6	180
83921	2	206, 494	84132	1	201	84331	8	167	84555	8	182	84730	9	192	84927	3	180
83922	9	206, 494	84133	8	201	84335	6	167	84556	5	182	84731	6	190	84928	0	180
83923	6	206	84134	5	201	84337	0	167	84558	9	182	84732	3	190	84929	7	180
83924	3	206	84135	2	201	84348	6	196	84559	6	182	84733	0	190	84930	3	181
83925	0	206	84158	1	200, 219	84349	3	196	84561	9	182	84750	7	221	84931	0	181
83926	7	206	84161	1	189	84351	6	196	84562	6	182	84775	0	223	84932	7	181
83929	8	195	84170	3	189	84353	0	196	84564	0	182	84776	7	223	84933	4	181
83932	8	197	84171	0	189	84355	4	195	84565	7	182	84777	4	223	84934	1	181
83933	5	197	84172	7	189	84365	3	174	84567	1	175	84778	1	223	84935	8	181
83935	9	197	84174	1	191	84366	0	174	84568	8	175	84779	8	223	84936	5	182
83941	0	198	84177	2	172	84377	6	174	84569	5	176	84780	4	223	84937	2	182
83946	5	198	84178	9	172	84378	3	174	84570	1	176	84781	1	223	84943	3	179
83947	2	198	84179	6	172	84379	0	174	84571	8	176	84782	8	223	84944	0	179
83949	6	198	84180	2	188	84380	6	174	84572	5	176	84783	5	223	84948	8	183
83955	7	185	84181	9	188	84381	3	174	84573	2	176	84785	9	203	84950	1	211
83956	4	185	84182	6	188	84400	1	169	84574	9	176	84803	0	163	84951	8	211
83957	1	185	84185	7	24, 188	84401	8	169	84575	6	175	84804	7	163	84958	7	211
83958	8	185	84186	4	24, 188	84402	5	169	84576	3	175	84805	4	163	84959	4	211
83960	1	202	84187	1	68, 188	84403	2	169	84577	0	176	84806	1	163	84962	4	181, 493
83961	8	202	84188	8	24, 188	84404	9	169	84578	7	176	84807	8	163	84963	1	181, 493
83962	5	202	84189	5	24, 188	84424	7	208	84579	4	176	84808	5	163	84964	8	181, 493
83971	7	185	84200	7	203	84425	4	208	84580	0	176	84815	3	163	84965	5	182, 493
83980	9	185	84202	1	203	84426	1	208	84581	7	176	84816	0	163	84966	2	182, 493
83981	6	186	84205	2	173	84427	8	208	84582	4	176	84819	1	163	84967	9	182, 493
83992	2	186	84206	9	173	84434	6	172	84583	1	182	84820	7	168	84968	6	182, 493
			84207	6	173	84444	5	222	84584	8	182	84821	4	168	84985	3	183
			84208	3	173	84445	2	222	84586	2	182	84824	5	169	84986	0	170

84987	7	183	85127	6	153	88637	7	445	93112	1	398	93256	2	476	93360	6	402
84988	4	170	85128	3	153	88639	1	463	93114	5	412	93257	9	476	93361	3	402
85021	7	148	85129	0	153	88640	7	444	93116	9	398	93258	6	476	93362	0	402
85024	8	148	85131	3	153	88642	1	444	93120	6	398	93259	3	475	93364	4	391
85025	5	148	85132	0	153	88643	8	450	93121	3	398	93260	9	475	93365	1	391
85026	2	148	85133	7	153	88644	5	450	93122	0	413	93261	6	475	93366	8	395
85027	9	148	85135	1	153	88645	2	450	93124	4	413	93270	8	476	93367	5	388
85028	6	148	85140	5	215	88688	9	466	93125	1	413	93271	5	476	93368	2	399
85029	3	149	85141	2	215	88717	6	464	93129	9	399	93272	2	476	93369	9	399
85030	9	149	85145	0	170	88810	4	456	93134	3	399	93273	9	476	93371	2	391
85036	1	149	85146	7	170	88811	1	456	93138	1	396	93274	6	476	93372	9	391
85037	8	149	85150	4	201	88823	4	456	93139	8	396	93275	3	476	93373	6	391
85038	5	149	85151	1	201	88826	5	456	93140	4	396	93280	7	477	93374	3	391
85040	8	217	85200	6	147	88827	2	456	93141	1	411	93281	4	477	93375	0	392
85041	5	217	85201	3	147	88829	6	457	93144	2	411	93300	2	400	93380	4	408
85042	2	217	85202	0	147	88834	0	457	93145	9	411	93301	9	413	93381	1	408
85043	9	217	85203	7	147	88836	4	457	93146	6	411	93302	6	413	93382	8	408
85055	2	149	85204	4	147	88839	5	458	93147	3	411	93303	3	409	93383	5	408
85056	9	149	85205	1	147	88840	1	458	93148	0	411	93304	0	409	93384	2	408
85057	6	149	85206	8	147	88843	2	401, 458	93152	7	399	93306	4	401	93385	9	408
85060	6	145	85207	5	147	88846	3	401, 457	93153	4	399	93307	1	401	93386	6	408
85061	3	145	85208	2	147	88850	0	457	93154	1	476	93308	8	266, 411	93390	3	408
85062	0	145	85211	2	184	88853	1	458	93155	8	475	93309	5	266, 411	93391	0	408
85063	7	144	85230	3	184, 216, 287	88855	5	473	93156	5	475	93310	1	389	93392	7	408
85064	4	144	85231	0	184, 216, 287	88900	2	473	93157	2	475	93311	8	389	93393	4	408
85065	1	144	85240	2	221, 239	88901	9	473	93160	2	412	93312	5	400	93394	1	408
85066	8	144	85241	9	221, 239	88902	6	473	93161	9	410	93313	2	400	93395	8	408
85067	5	144	85242	6	221, 239	88903	3	474	93163	3	476	93318	7	401, 464	93398	9	392
85068	2	144	85243	3	221, 239	88911	8	473	93164	0	397	93321	7	138, 367	93399	6	392
85069	9	145	85244	0	221, 239	88912	5	473	93165	7	397	93322	4	389	93400	9	392
85070	5	145	85250	1	214	88920	0	459	93166	4	409	93323	1	389	98120	1	90
85071	2	145	85251	8	214	88921	7	459	93167	1	409	93324	8	397			
85072	9	145	85252	5	214	88922	4	459	93168	8	409	93325	5	396			
85073	6	144	85260	0	209	88923	1	459	93169	5	409	93326	2	395			
85074	3	146	85261	7	209	88928	6	459	93170	1	410	93327	9	393			
85075	0	146	85266	2	209	88929	3	461	93171	8	401	93328	6	393			
85076	7	146	85267	9	209	88930	9	461, 480	93173	2	409	93329	3	393			
85077	4	146	88080	1	479	88932	3	459	93174	9	409	93330	9	372, 388			
85080	4	150, 246	88081	8	479	88933	0	459	93175	6	409	93331	6	390			
85081	1	150, 246	88090	0	478	88935	4	460	93176	3	401	93332	3	390			
85082	8	151	88099	3	462	88937	8	460	93179	4	396	93333	0	390			
85083	5	151	88220	1	231	88938	5	460	93180	0	402	93334	7	392			
85084	2	151	88221	8	231	88939	2	460	93181	7	402	93335	4	392			
85088	0	187	88222	5	231	88940	8	460	93182	4	402	93336	1	393			
85092	7	146	88223	2	231	88941	5	460	93189	3	403, 472	93337	8	393			
85093	4	146	88224	9	231	88942	2	460	93190	9	407	93338	5	393			
85097	2	146	88225	6	231	88946	0	461	93191	6	406	93342	2	390			
85098	9	144	88226	3	231	88947	7	461	93192	3	406	93343	9	390			
85099	6	83, 186	88227	0	231	88948	4	461	93200	5	405	93344	6	390			
85100	9	152	88228	7	231	88949	1	462, 480	93201	2	396	93345	3	389			
85101	6	152	88229	4	231				93211	1	395	93346	0	388			
85103	0	152	88256	0	480	<b>9</b>			93212	8	395	93347	7	400			
85104	7	152	88271	3	477	90902	1	34	93214	2	403, 472	93348	4	400			
85105	4	152	88285	0	360	93034	6	399	93220	3	405	93349	1	400			
85107	8	152	88287	4	473	93090	2	54, 380	93225	8	475	93350	7	396			
85108	5	152	88288	1	473	93091	9	54, 380	93226	5	475	93351	4	397			
85109	2	152	88598	1	453	93092	6	54, 380	93230	2	54	93352	1	397			
85111	5	152	88608	7	445	93093	3	54, 380	93250	0	476	93353	8	397			
85120	7	153	88609	4	453	93101	5	411	93251	7	476	93354	5	397			
85121	4	153	88618	6	463	93102	2	412	93252	4	476	93355	2	397			
85123	8	153	88627	8	453	93105	3	54, 380	93253	1	476	93356	9	398			
85124	5	153	88628	5	453	93110	7	412	93254	8	476	93357	6	398			
85125	2	153	88636	0	453	93111	4	412	93255	5	476	93358	3	402			







## **DE Impressum**

Herausgeber: Assheuer + Pott GmbH & Co. KG, Talweg 11, 59846 Sundern, Tel. +49 2933 97350, info@aps-germany.de, www.aps-germany.de  
Gestaltung: Assheuer + Pott GmbH & Co. KG · Druck: Druck- und Verlagshaus Fromm + Rasch GmbH & Co. KG, Breiter Gang 10-16, 49074 Osnabrück  
Wir behalten uns das Recht vor, die angegebenen Spezifikationen jederzeit zu ändern. Irrtum, Druckfehler und technische Änderungen vorbehalten. Artikelbeschreibungen sowie Abbildungen und Fotodarstellungen sind ohne Gewähr. Alle Angebote ohne Dekoration. Alle Preise verstehen sich unverbindlich (UVP) in Euro zuzüglich der gesetzlichen Mehrwertsteuer.  
© 2023 - Die Vervielfältigung dieses Kataloges - auch wenn partial - muss ausschließlich von der Assheuer + Pott GmbH & Co. KG genehmigt werden.  
Bildnachweis: Niklas Thiemann Fotodesign · Stoll GmbH – Studio für Fotografie · track by track GmbH · iStock · Envato Elements Pty Ltd.

## **GB Imprint**

Editor: Assheuer + Pott GmbH & Co. KG, Talweg 11, 59846 Sundern, Germany, Tel. +49 2933 97350, info@aps-germany.de, www.aps-germany.de  
Design: Assheuer + Pott GmbH & Co. KG - Print: Druck- und Verlagshaus Fromm + Rasch GmbH & Co. KG, Breiter Gang 10-16, 49074 Osnabrück, Germany  
We reserve the right to alter at any time the specifications stated without notice. Errors, printing error and technical changes reserved. Item description as well as images and illustrations are without guaranty. All offers are without decoration. All prices are without commitment (RRP) in Euro and exclude the legal VAT prescribed by law.  
© 2023 - This catalogue may not be reproduced in whole or in part unless specific prior written authorization of Assheuer + Pott GmbH & Co. KG.  
Picture credits: Niklas Thiemann Fotodesign · Stoll GmbH – Studio für Fotografie · track by track GmbH · iStock · Envato Elements Pty Ltd.

## **ES Impressum**

Editor: Assheuer + Pott GmbH & Co. KG, Talweg 11, 59846 Sundern, Alemania, Tel. +49 2933 97350, info@aps-germany.de, www.aps-germany.de  
Diseño gráfico: Assheuer + Pott GmbH & Co. KG - Impresión: Druck- und Verlagshaus Fromm + Rasch GmbH & Co. KG, Breiter Gang 10-16, 49074 Osnabrück, Alemania  
Nos reservamos el derecho de efectuar modificaciones en cualquier momento, sin aviso previo. Salvo errores de imprenta o impresión o cambios técnicos. La descripción de los artículos, sus imágenes e ilustraciones son sin garantía. Los artículos se ofrecen sin decoración. Todos los precios indicados son precios sugeridos (PVR) en euros y a dichos precios se deberá añadir el impuesto sobre el valor añadido legal vigente.  
© 2023 - Todas las reproducciones, aunque parciales, de este catálogo tienen que ser autorizadas por escrito por Assheuer + Pott GmbH & Co. KG.  
Derechos de la imagen: Niklas Thiemann Fotodesign · Stoll GmbH – Studio für Fotografie · track by track GmbH · iStock · Envato Elements Pty Ltd.

## **FR Impressum**

Éditeur: Assheuer + Pott GmbH & Co. KG, Talweg 11, 59846 Sundern, Allemagne, Tel. +49 2933 97350, info@aps-germany.de, www.aps-germany.de  
Design: Assheuer + Pott GmbH & Co. KG - Impression: Druck- und Verlagshaus Fromm + Rasch GmbH & Co. KG, Breiter Gang 10-16, 49074 Osnabrück, Allemagne  
Nous nous réservons le droit de modifier à tout moment les spécifications. Toutes erreurs, fautes d'impression et modifications techniques sont réservées. Les descriptions d'articles, les illustrations et les photos sont sans garantie. Toutes les articles s'entendent hors décoration. Tous les prix sont donnés sans engagement (PVC) et s'entendent en Euro et T. V. A. légale en vigueur non incluse.  
© 2023 - Toute reproduction même partielle de ce catalogue est interdite sauf autorisation expresse de Assheuer + Pott GmbH & Co. KG.  
Crédit photo: Niklas Thiemann Fotodesign · Stoll GmbH – Studio für Fotografie · track by track GmbH · iStock · Envato Elements Pty Ltd.



buffet | tabletop | bar

**Assheuer + Pott GmbH & Co. KG**

Talweg 11 | 59846 Sundern  
Germany

Phone: +49 (0) 29 33 / 97 35 - 0  
E-Mail: [info@aps-germany.de](mailto:info@aps-germany.de)

[aps-germany.de](http://aps-germany.de)

KATALOG NR 49  
CATALOG NO 49  
CATÁLOGO N° 49  
CATALOGUE N° 49



Keep in touch!  
[aps\\_germany](http://aps_germany)

no. 3775



4 004133 037755